



Brand of the Stars - Since 1949

Catalogue 2021

Professional · Hotel · Restaurant





“Brand of the stars”



Liderazgo · Leadership · Leadership

Somos una marca referencia dentro del sector de la hostelería y menaje doméstico. Tras años de esfuerzo nos hemos ganado una posición de liderazgo y nos hemos convertido en un referente en el sector.

Nous sommes une marque de référence dans le secteur de l'hôtellerie et des articles ménagers. Après de nombreuses années d'efforts, nous avons atteint une position de leadership et avons pu devenir une référence dans le secteur.

Lacor is a leading brand within the hospitality and catering and houseware sectors. After years of effort the company has earned a leadership position and has become a reference in the sector.

Tradición · Tradition · Tradition

Perteneceemos a una tierra de profundas raíces gastronómicas, donde nuestros artesanos comenzaron a fabricar las primeras cazuelas hace 70 años. Hoy día mantenemos el mismo espíritu y pasión por nuestra propia historia.

Nous sommes issus d'une région aux profondes racines gastronomiques, où nos artisans ont commencé à fabriquer les premières casseroles il y a 70 ans. Nous conservons aujourd'hui le même état d'esprit et la même passion pour notre propre histoire.

Lacor comes from lands with deep gastronomic roots, where its artisans began to manufacture their first casseroles 70 years ago. The same spirit and passion of this long history is still maintained today.

Calidad · Qualité · Quality

Integramos la cultura de calidad tanto en nuestros procesos de fabricación y productos como en la relación con nuestros clientes y colaboradores, lo cual nos ha permitido ganarnos su confianza a lo largo del tiempo.

Nous intégrons la culture de la qualité aussi bien dans nos processus de fabrication et nos produits que dans la relation avec nos clients et collaborateurs, ce qui nous a permis de gagner leur confiance au fil du temps.

Lacor integrates a culture of quality into its manufacturing processes and products as well as in relationships with its customers and collaborators, which has enabled the company to earn their trust over time.

Empresa global · Entreprise globale · Global company

Tenemos presencia en 90 países a lo largo de los 5 continentes. A través del esfuerzo de nuestros distribuidores hemos conseguido llegar a las cocinas profesionales y hogares de todo el mundo.

Nous sommes présents dans 90 pays répartis sur les 5 continents. À travers les efforts de nos distributeurs, nous avons pu pénétrer dans les cuisines professionnelles et les foyers du monde entier.

Lacor is present in 90 countries on the five continents. Through the efforts of its distributors the company has reached professional kitchens and homes around the world.

Equipo humano · L'équipe · Team

Lacor está compuesto por un equipo cualificado de personas con un alto grado de compromiso hacia el servicio. Gracias a nuestra dedicación conseguimos establecer relaciones duraderas y de confianza con nuestra clientela.

Lacor est composé d'une équipe qualifiée de personnes hautement engagées envers le service. Grâce à notre dévouement, nous pouvons établir des relations durables et de confiance avec notre clientèle.

Lacor is made up of a qualified team of people with a high level of commitment towards service. Thanks to their dedication, the company establishes lasting relationships based on trust with its clientele.



Keep in touch with Lacor worldwide



EUROPE

Andorra
Austria
Belgium
Bulgaria
Czech Republic
Croatia
Cyprus
Denmark
Finland
France
Germany
Greece
Holland
Hungary
Iceland
Ireland
Italy
Latvia
Lithuania
Luxembourg
Macedonia
Montenegro
Poland
Portugal
Romania
Russia
Serbia
Slovenia
Spain
Sweden
Switzerland
Turkey
UK+ N. Ireland
Ukraine

ASIA

Azerbaijan
Cambodia
China
Hong Kong
India
Indonesia
Iran
Iraq
Israel
Japan
Jordan
Kazakhstan
Kuwait
Lebanon
Macau
Malaysia
Philippines
Qatar
Russia
Saudi Arabia
Singapore
South Korea
Sri Lanka
Taiwan
Thailand
UAE
Vietnam

AMERICA

Argentina
Bolivia
Brazil
Canada
Chile
Colombia
Costa Rica
Cuba
Dominican Rep.
French Guayana
Guadalupe
Guatemala
Honduras
Jamaica
Martinique
Mexico
Paraguay
Peru
United States
Uruguay

AFRICA

Algeria
Burkina Faso
Cape Verde
Egypt
Ethiopia
Ivory Coast
Kenya
Libya
Mauricio
Morocco
Reunion Island
Senegal
Seychelles
South Africa
Tunisia

OCEANIA

Australia
New Zealand

· Condiciones generales de venta ·

- 1.- Los precios de la presente tarifa anulan los anteriores.
- 2.- En los precios están incluidos los conceptos de embalaje.
- 3.- Los portes serán PAGADOS a partir de los siguientes importes netos mínimos:
 - a.- Península y Baleares: 300 €
 - b.- Canarias, Ceuta y Melilla: 600 €
 - c.- Francia y Alemania: 775 €
 - d.- Reino Unido: 700 € / £ 600
 - e.- Benelux e Irlanda: 1.200 €
 - f.- Italia: 1.500 €
 - g.- Para resto de países consultar
- 4.- El medio de transporte será a elección de esta Empresa.
Cuando se desee el envío por un medio diferente al habitual de LACOR, los portes serán DEBIDOS.
- 5.- La forma de pago será mediante GIRO DOMICILIADO y el plazo máximo para el pago serán 60 días.
Otras formas de pago deberán ser autorizadas por la dirección de la Empresa.
- 6.- Todas las devoluciones de mercancías tienen que ser autorizadas por la Empresa.
Las devoluciones que no sean por problemas de calidad deberán llegar a portes pagados y se abonarán al 90% del valor de la mercancía.
- 7.- Las fotos, datos y medidas que aparecen en este catálogo son indicativos y susceptibles, sin previo aviso, de modificación por exigencias técnicas o de producción.

· Conditions générales de vente ·

- 1.- Les présents tarifs annulent les précédents.
- 2.- Dans les prix sont inclus les concepts d'emballage.
- 3.- Les ports seront PAYÉS à partir des montants nets suivants de facture minimums:
 - a.- Péninsule Ibérique et Baléares : 300 €
 - b.- Canaries, Ceuta et Melilla : 600 €
 - c.- France et Allemagne : 775 €
 - d.- Royaume Uni : 700 € / £ 600
 - e.- Bénélux et Irlande : 1.200 €
 - f.- Italie : 1.500 €
 - g.- Pour le reste des pays, prière de le consulter
- 4.- Le moyen de transport sera au choix de cette entreprise.
Si l'on désire l'envoi par un moyen différent à celui pratiqué habituellement par LACOR, les ports seront DUS.
- 5.- La forme de paiement sera par LETTRE DE CHANGE BANCAIRE et le délai de paiement maximum sera de 60 jours.
D'autres formes de paiement devant être autorisées par la Direction de l'Entreprise.
- 6.- Tous les retours de marchandises doivent être autorisés par l'Entreprise.
Les retours qui ne seront pas dus à des problèmes de qualité devront arriver avec les frais de ports payés et seront remboursés à 90% de la valeur de la marchandise.
- 7.- Les photos, données et mesures qui apparaissent dans ce catalogue sont à titre indicatif et sont susceptibles de modifications pour exigences techniques ou de production.

· Allgemeine geschäftsbedingungen ·

- 1.- Die Preise der vorliegenden Preisliste annullieren alle vorherigen.
- 2.- In den Preisen ist die VerU.Ventaung bereits enthalten.
- 3.- Die Transportkosten werden ab folgenden Mindestnettorechnungsbeträgen von uns ÜBERNOMMEN:
 - a.- Iberische Halbinsel und Balearen: 300 €
 - b.- Kanaren, Ceuta und Melilla: 600 €
 - c.- Frankreich und Deutschland: 775 €
 - d.- Vereinigtes Königreich: 700 € / £ 600
 - e.- Benelux und Irland: 1.200 €
 - f.- Italien: 1.500 €
 - g.- Für andere Länder bitte anfragen
- 4.- Das Transportmittel liegt im Ermessen dieses Unternehmens. Wenn der Versand durch ein bestimmtes Transportmittel gewünscht wird, das nicht mit dem bei LACOR üblichen übereinstimmt, werden die Transportkosten IN RECHUNG GESTELLT.
- 5.- Die Zahlungsform erfolgt per EINZUGSVERFAHREN und das Zahlungsziel beträgt maximal 60 Tage.
Andere Zahlungsform müssen vor den Geschäftsleitung des Unternehmens genehmigt werden.
- 6.- Alle Retouren von Ware müssen von der Geschäftsleitung bewilligt werden.
Die Retouren, die nicht Qualitätsprobleme betreffen, müssen mit gezahlten Portokosten geschickt werden.
Es werden 90% des Warenwerts zurückerstattet.
- 7.- Die in diesem Katalog enthaltenen Fotos, Informationen und Maße sind beschreibender Art und können aufgrund technischer oder produktionsbezogener Erfordernisse ohne vorherige Ankündigung geändert werden.

· General conditions of sale ·

- 1.- Current rate prices cancel prior rates.
- 2.- U.Ventaaging is included in the prices.
- 3.- Freight shall be PAID from the following minimum invoice amounts:
 - a.- Peninsula and Balearic: 300 €
 - b.- Canary Islands, Ceuta and Melilla: 600 €
 - c.- France and Germany: 775 €
 - d.- United Kingdom: 700 € / £ 600
 - e.- Benelux and Ireland: 1.200 €
 - f.- Italy: 1.500 €
 - g.- For all other countries: please ask
- 4.- The transportation method shall be selected by this Company.
When the delivery is requested through other means than the usual LACOR, freight be DUE.
- 5.- The payment method will be DIRECT PAYMENT and the payment terms will be a maximum of 60 days.
Any other type of payment must be authorized by Company management.
- 6.- All merchandise returns must be authorized by the Company.
Returns not made due to quality concerns must be delivered with freight paid and will be paid at 90% of the merchandise value.
- 7.- Photos, information and measurements that appear in this catalogue are for information and may be modified due to technical or production requirements at any time.

· Condições gerais de venda ·

- 1.- Os preços do presente tarifário anulam os anteriores.
- 2.- Nos preços estão incluídas as taxas de embalagem.
- 3.- Os portes serão PAGOS a partir dos seguintes valores líquidos mínimos:
 - a.- Península e Ilhas Baleares: 300 €
 - b.- Ilhas Canárias, Ceuta e Melilha: 600 €
 - c.- França e Alemanha: 775 €
 - d.- Reino Unido: 700 € / £ 600
 - e.- Benelux e Irlanda: 1.200 €
 - f.- Itália: 1.500 €
 - f.- Para o resto dos países, consultar
- 4.- O meio de transporte será à escolha desta Empresa.
Quando se desajar o envio por um meio diferente do habitual da LACOR, os portes serão BEVIDOS.
- 5.- A forma de pagamento será a de PAGAMENTO DOMICILIADO e o prazo máximo para o pagamento será 60 dias.
Outras formas de pagamento deverão ser autorizadas pela Direção da Empresa.
- 6.- Todas as devoluções de mercadorias têm de ser autorizadas pela Empresa.
As devoluções que não sejam devidas a problemas de qualidade deverão ser enviadas a portes pagos e serão pagas 90% do valor da mercadoria.
- 7.- As fotografias, dados e dimensões que constam deste catálogo são indicativos e suscetíveis, sem aviso prévio, de alteração por exigências técnicas ou de produção.

Leyenda · Légende · Legend

Materiales · Matériaux · Materials

A	Acacia wood	Acacia Bois d'acacia Acacia wood	M	Madera Caucho Rubberwood	Madera de caucho Bois de caoutchouc Rubber wood	
	Acero Cromado Chromesteel	Acero cromado Acier chromé Chrome steel		Material Embutido Clap Unset	Material Embutido Matériel d'incrustation Inlaying material	
	ASA Acrylic	Acrílico Acrylique Acrylic		MF Melamine	Melamina (trímero) Mélamine (trimère) Melamine (trimer)	
	ABS plastic	Acrlonitrilo butadieno estireno (termoplástico) Acrylonitrile Butadiène Styène (Thermoplastique) Acrylonitrile Butadiène Styrene (Thermoplastic)		N	PA Nylon	Nylon Nylon Nylon
AL Aluminium	Aluminio Aluminium Aluminium	P	Pizarra Slate		Pizarra Natural 100% 100% ardoise naturelle 100% Natural Slate	
			SAN plastic		Plástico estireno acrlonitrilo Plastique acrylonitrile styène Acrylonitrile styrene plastic	
B	Bambú bamboo	Bambú Bois de bambou Bamboo wood	PMMA plastic		Plástico Polimetilmetacrilato Plastique polyméthacrylate de méthyle Polymethyl methacrylate plastic	
	C	TPR plastic	Caucho termoplástico Caoutchouc thermoplastique Thermoplastic rubber	PC Polycarbon	Policarbonato Polycarbonate Polycarbonate	
CE Ceramic		Cerámico Céramique Ceramic	PS plastic	Poliestireno (polímero termoplástico) Polystyrène (polymère thermoplastique) Polystyrene (thermoplastic polymer)		
C Glass		Cristal Verre Glass				
E	TPE plastic	Elastómero termoplástico Élastomère thermoplastique Thermoplastic elastomer	PE Polyethylene	Poliétileno (polímero) Polyéthylène (polymère) Polyethylene (polymer)		
F	Fibra de vidrio Fiberglass	Fibra de vidrio Fibre de verre Fiberglass	HPPE Polyethylene	Poliétileno de alta densidad (polímero) Polyéthylène haute densité (polymère) High-density polyethylene (polymer)		
	FO Wrought	Forjado Forgée Wrought	PELD Polyethylene	Poliétileno de baja densidad (polímero) Polyéthylène basse densité (polymère) Low density polyethylene (polymer)		
	FU Cast	Fundido Fondu Cast	LDPE Polyethylene	Poliétileno de baja densidad (polímero) Polyéthylène basse densité (polymère) Low density polyethylene (polymer)		
G	GEL Liquid	Gel líquido desinfectante Gel désinfectant liquide Liquid disinfectant gel	PP Polypropylene	Polipropileno (polímero) Polypropylène (polymère) Polypropylene (polymer)		
H	Haya Beech Wood	Haya Bois de hêtre Beech wood	S	Si Silicone	Silicona Silicone Silicone	
	FE Iron	Hierro Fer Iron		Z	Zinc Alloy	ZAMAK ZAMAK ZAMAK
	Hierro colado Cast Iron	Hierro colado Fonte Cast Iron			CZ Zirconia	Zirconia Zirconé Zirconia
HIGIENIZANTE Liquid	Líquido higienizante Liquide désinfectant Sanitizing liquid					
I	Inox	Inoxidable Acier inoxydable Stainless steel				
	Inox 18/10	Inoxidable 18/10 Acier inoxydable 18/10 Stainless steel 18/10				

Características · Caractéristiques · Characteristics

- A**  **Antiadherente libre de PFOA**
Antiadhésif sans PFOA
PFOA free non-stick
-  **Antiadherente**
Antiadhésif
Non-stick
-  **Apto para el lavavajillas**
Lave-vaisselle
Dishwasher safe
-  **Apto para llama**
Convient pour la flamme
Suitable for flame
-  **Apto para el congelador**
Va au congélateur
Freezer safe
-  **Apto para el horno**
Va au four
Oven safe
-  **Apto para el microondas**
Va au micro-ondes
Microwave safe
-  **Artículo apilable**
Article empilable
Stackable item
- C**  **Certificado de Conformidad Europea**
Certificat de conformité européen
European Certificate of Conformity
-  **Certificado en gestión forestal y cadena de custodia**
Certifié en gestion forestière et chaîne de contrôle
Certified in forest management and chain of custody
-  **Certificado ISO 14001. Sist. de gestión ambiental**
Certificat ISO 14001. Syst. gestion environnementale
ISO 14001 certificate. Syst. environmental management
-  **Cocina eléctrica**
Cuisinier électrique
Electric cook
-  **Cocina de gas**
Cuisinière à gaz
Gas cook
-  **Cocina de inducción**
Cuisinier à induction
Induction cook
-  **Cocina saludable**
Cuisine saine
Healthy cooking
-  **Cocina vitrocerámica**
Cuisinier vitrocéramique
Vitreoceramic cook
- D**  **Directiva 2011/65/UE de Restricción de ciertas Sustancias Peligrosas**
Directive 2011/65 / UE sur les restrictions de certaines substances dangereuses
Directive 2011/65 / EU on Restriction of Certain Hazardous substances
- 87**
HRc **Dureza del artículo**
Dureté de l'article
Item Hardness
- E**  **Etiqueta ecológica para productos textiles**
Label écologique pour les produits textiles
Eco label for textile products
- F**  **Fondo Sandwich**
Fond de sandwich
Sandwich background
- I**  **Instituto Técnico Español de Limpieza**
Institut technique espagnol du nettoyage
Spanish Technical Institute for Cleaning
- L**  **Lavar con un trapo húmedo**
Laver avec un chiffon humide
Wash with a damp cloth
-  **Libre de BPA**
Sans BPA
BPA free
- M**  **Material Blando y Flexible**
Matériau souple et flexible
Soft and Flexible Material
-  **Material Ecológico**
Matériel écologique
Ecological Material
-  **Motor de corriente alterna**
Moteur à courant alternatif
Alternating current motor
-  **Motor de corriente continua**
Moteur à courant continu
Continuous current motor
- N**  **Nivel de Protección al polvo y agua**
Niveau de protection contre la poussière et l'eau
Dust and water protection level
-  **Nivel de temperatura máxima**
Niveau de température maximum
Maximum temperature level
-  **Nº de capas del antiadherente**
Nombre de couches antiadhésives
No. of non-stick layers
-  **Nº de hojas que tiene el portamenú**
Nombre de feuilles dans le support de menu
Number of sheets in the menu holder
-  **Normas creadas por los Comités Técnicos de Normalización de la Asociación Española**
Normes créées par les comités de normalisation technique de l'Association espagnole
Standards created by the Technical Standardization Committees of the Spanish Association
- P**  **Peso que puede aguantar el artículo**
Poids que l'article peut contenir
Weight the item can hold
-  **Prohibido transportar en avión**
Interdit de transporter en avion
Forbidden to transport by plane
- S**  **Sistema de gestión de la calidad para dispositivos médicos**
Système de gestion de la qualité des dispositifs médicaux
Quality management system for medical devices
-  **Todo aquel icono de la lista de la leyenda que contenga un aspa en rojo significa que no es apto**
Toute icône de la liste contenant une croix rouge signifiera qu'elle ne lui convient pas
Jedes Symbol in der Legendenliste, das ein rotes Kreuz enthält, bedeutet, dass es nicht dafür geeignet ist
Any icon in the legend list that contains a red cross will mean that it is not suitable for it
Qualquer ícone na lista de legendas que contenha uma cruz em vermelho, significa que não é adequado

Novedades · Nouveautés · Novelties

LACOR completa su amplio catálogo de menaje de cocina incluyendo novedosos artículos que mejoran el día a día y con los que conseguirás resultados sorprendentes.

Una vez más, ha dedicado especial atención a la calidad y diseño de los nuevos artículos y trabajado minuciosamente para que todos ellos cumplan las expectativas.

LACOR complète son large catalogue d'ustensiles de cuisine en incluant des articles innovants qui améliorent le quotidien et avec lesquels vous obtiendrez des résultats surprenants.

Une fois encore, une attention particulière a été portée à la qualité et au design des nouveaux articles et un travail minutieux a été réalisé afin que chacun d'entre eux réponde à vos attentes.

LACOR erweitert seinen umfangreichen Katalog von Küchenutensilien um innovative Artikel, die Ihnen den Alltag leichter machen und mit denen das Kochen erstaunlich gut gelingt.

Besonders wurde dabei an Qualität und Design der neuen Artikel gefeilt, um all Ihre Erwartungen zu erfüllen.

LACOR rounds out its kitchenware collection with novel items that help improve your day to day and achieve surprising results.

Once again, special attention has been paid to the quality and design of the new items, all of which have been perfectly crafted to exceed your expectations.

LACOR completa o seu amplo catálogo de utensílios de cozinha, com artigos inovadores, para tornar mais fácil o dia-a-dia dos nossos clientes e conseguir resultados surpreendentes.

Mais uma vez, dedicamos uma especial atenção à qualidade e ao design dos novos artigos, desenvolvendo todos os esforços para que estes satisfaçam todas as expectativas.





70 Sartén PREMIUM
PREMIUM frying-pan



76 Plancha grill FERRUM
FERRUM grill plat plaque



80 Colección JAVA
JAVA Collection



83 Set 2 sartenes FOGO
FOGO 2 frying-pans set



84 Sartén GARINOX
GARINOX frying-pan



119 Utensilios silicona GREY
391 GREY silicon utensils



121 Batidor con espátula
387 Whisk with spatula



143 Dosificador INOX
397 Portionner



146 Manguera doble ahumador
Double smoker accessory



146 Serrín ahumador 600 g
Wood chips, 600 g



164 Melamina EARTH / SEA
166 Melamine



175 Colección STONE-Melamina
STONE collection-Melamine



181 Manteles de mesa
Tablecloths



182 Posavasos / Servilleteros
Coasters / Napkin rings



197 Mini palet presentación
Mini pallet for presentation



211 Pinzas para té
224 Tea tongs



214 Desescamador pescado
Fish scraper



216 Molinillo eléctrico
480 Electric grinder



218 Espumador de leche
479 Milk frother



219 Cafetera espresso SENCE
481 Espresso coffee maker



225-7 Hervidores de agua
476-8 Electric kettles



230 Jarras termo
Vacuum flasks



235 Fundas enfriabotellas
Bottle cooler covers



243 Vasos Tritán
Tritan glasses



245 | Soporte copas
Cups stand



246 | Accesorios cóctel
Cocktail accessory



249 | Abrebotellas pared
Wall mounted bottle
opener



252 | Atril Porta menú
Menu holder lectern



255 | Porta menú sobremesa
Menu cover



256 | Vitrina Expositora Bar
Bar Display Case



262 | Porta menú PVC
Menu cover



297 | Machete
Cleaver



305 | Tabla de corte COLLECT
Cutting board



306 | Tablas de corte
Cutting boards



307 | Tajo de corte carnicero
Butcher Block



309 | Tablas de corte Polietileno
Polyethylene cutting board



325 | Organizador Café
Coffee organizer



342 | Soporte para cubetas
Cuvette support



373 | Dispensadores de jabón/gel
Soap and gel dispenser



374 | Soporte dispensador
Dispenser support



375 | Geles hidroalcohólicos
Hydroalcoholic hand gel



375 | Higienizante superficies
Hygienising for surfaces



376 | Papeleras pedal
Pedal bins



377 | Dispensador film
Film dispenser



380 | Postes separadores BLACK
Separator post



384 | Cucharas/cazos medidores
Measuring cups



388 | Rodillo Inox con anillas
Rolling pin with guide rings



395 | Soplete gas
Blow torch



402 | Aerógrafo con compresor
467 | Airbrush w/compressor



406 | Racionador helado
Ice cream scoop



408 | Moldes BLACK
Black moulds



432 | Batidoras-amasadoras
Mixer-kneader



443 | Picadora de cristal
Glass electric mincer



446 | Cortadora de vegetales
Vegetables slicer



487 | Exprimidor automático
Automatic juicer



492 | Batidora personal PRO
Individual blender



515 | Armario refrigerador
Wine cooler



525 | Matamosquitos WHITE
WHITE mosquito killer



528 | Calentadores
Electric heater

Índice

Menaje / Cookware

Baterías Profesionales / Professional Cookware	18
Baterías Domésticas / Household Cookware	29
Ollas a presión / Pressure Cookers	63
Sartenes / Frypans	68
Rustideras · Horno / Roasting Pans · Oven	87
Paelleras / Paella Pans	95



Utensilios / Utensils

Juegos de Cocina / Kitchen Tools	102
Preparación / Food Processing	114
Básculas · Termómetros / Scales · Thermometers	148



Mesa / Table Top

Bandejas · Fuentes / Trays	158
Melamina / Melamine	163
Servicio Mesa / Table Service	180
Pinzas / Tongs	207
Cafetería / Cafeteria	215
Termos / Thermos	229
Bar · Bodega / Wine Cellar	234
Portamenú / Portamenu	257



Corte / Cutting

Corte / Cutting	279
-----------------	-----



Index



313

Chafing Dish · Buffet / Chafing Dish · Buffet

Buffet



342

Cubetas / Containers

350

Transporte · Estanterías / Transport · Shelves

367

Cestas / Racks

372

Limpieza / Cleaning

Gastronorm



384

Preparación Repostería / Pastry Processing

407

Moldes · Aros / Moulds · Cake Rings

Repostería / Pastry



425

Eléctrico / Electric

Eléctrico / Electric



MENAJE COOKWARE

Baterías Profesionales
Professional Cookware

Baterías Domésticas
Household Cookware

Ollas a presión
Pressure Cookware

Sartenes
Frypans

Rustideras - Horno
Roasting Pans - Oven

Paelleras
Paella Pans





Toda la pieza (cuerpo, asas y mangos) fabricada en Acero Inoxidable 18/10.
Fondo Termodifusor (Inox 18/10 - Aluminio - Inox).
Espesor 1,5 - 2 mm.
Tapas diseñadas para el ahorro energético.
Máxima garantía en cuanto a resistencia, durabilidad e higiene.
Apta para todos los tipos de cocina (incluida inducción y horno).

Toute la pièce (corps, poignées et manches) est fabriquée en acier inoxydable 18/10.
 Fond thermo-diffuseur (Inox 18/10 - Aluminium - Inox)
 Épaisseur: 1,5 - 2 mm
 Couvertres conçus pour une économie d'énergie
 Garantie maximale en termes de résistance, de durabilité et d'hygiène
 Compatible avec tous les types de cuisinières (y compris induction et four).

Ganzes Stück (Topf, Griffe und Stiele) aus rostfreiem Stahl 18/10
 Wärmeleitender Boden (Edelstahl 18/10 - Aluminium - Edelstahl)
 1,5 - 2 mm dick
 Energieeffizient geformte Deckel
 Garantiert robust, langlebig und hygienisch
 Für alle Herdarten geeignet (inkl. Induktion und Ofen).

The whole product (body, handles and grips) is made in 18/10 stainless steel.
 Heat diffuser bottom (18/10 stainless steel - Aluminium - Stainless)
 Thickness 1,5 - 2 mm
 Covers designed for saving energy
 Maximum guaranteed in terms of resistance, durability and hygiene
 Suitable for all types of cooking surfaces (including induction and the oven).

Peça fabricada inteiramente (corpo, asas e mangos) em aço inoxidável 18/10.
 Fundo termodifusor (Inox 18/10 - Alumínio - Inox)
 Espessura 1,5 - 2 mm
 Tampas concebidas para poupar energia
 Máxima garantia de resistência, durabilidade e higiene
 Apta para todos os tipos de fogões (incluindo placas de indução e forno)

Cacerola con tapa

Faitout avec couvercle
 Bratentopf mit Deckel
 Casserole with lid
 Caçarola com tampa

Ref	€	Ø (cm)	h (cm)	e (mm)	L	U.Venta
54020	70,45	20	10,0	1,5	2,90	1
54024	84,35	24	11,0	1,5	4,25	1
54028	97,84	28	11,0	1,5	6,70	1
54032	121,80	32	12,5	1,5	10,00	1
54036	147,95	36	14,0	1,5	14,20	1
54040	191,21	40	15,5	2,0	19,40	1
54045	227,32	45	17,0	2,0	27,00	1
* 54050	285,11	50	20,0	2,0	38,20	1

* NO inducción · NOT induction

Cacerola sin tapa

Faitout sans couvercle
 Bratentopf ohne Deckel
 Casserole without lid
 Caçarola sem tampa

Ref	€	Ø (cm)	U.Venta
54020S	55,61	20	1
54024S	67,33	24	1
54028S	78,54	28	1
54032S	98,15	32	1
54036S	119,11	36	1
54040S	159,15	40	1
54045S	190,59	45	1
* 54050S	241,43	50	1

* NO inducción · NOT induction



Cacerola alta con tapa

Braisière avec couvercle
 Fleischtopf mit Deckel
 Deep casserole with lid
 Caçarola alta com tampa

Ref	€	Ø (cm)	h (cm)	e (mm)	L	U.Venta
54021	73,66	20	13,0	1,5	4,00	1
54025	91,61	24	14,0	1,5	6,70	1
54029	111,43	28	17,5	1,5	10,70	1
54033	130,31	32	18,0	1,5	14,60	1
54037	165,21	36	21,5	1,5	21,80	1
54041	215,90	40	24,5	2,0	30,00	1
54046	256,16	45	27,5	2,0	43,70	1
* 54051	338,02	50	30,0	2,0	58,80	1

* NO inducción · NOT induction

Cacerola alta sin tapa

Braisière sans couvercle
 Fleischtopf ohne Deckel
 Deep casserole without lid
 Caçarola alta sem tampa

Ref	€	Ø (cm)	U.Venta
54021S	58,72	20	1
54025S	74,60	24	1
54029S	92,13	28	1
54033S	106,65	32	1
54037S	137,47	36	1
54041S	183,85	40	1
54046S	219,43	45	1
* 54051S	294,34	50	1

* NO inducción · NOT induction



Olla con tapa

Marmite traiteur avec couvercle
 Suppentopf mit Deckel
 Casserole with lid
 Caçarola com tampa

Ref	€	Ø (cm)	h (cm)	e (mm)	L	U.Venta
54120	81,55	20	20,0	1,5	6,20	1
54124	99,39	24	24,0	1,5	10,50	1
54128	120,14	28	28,0	1,5	17,20	1
54132	162,99	32	32,0	1,5	25,70	1
54136	201,28	36	36,0	1,5	36,50	1
54140	250,87	40	40,0	2,0	50,00	1
54145	320,90	45	45,0	2,0	71,50	1
* 54150	453,39	50	50,0	2,0	98,00	1

* NO inducción - NOT induction

Olla recta sin tapa

Marmite traiteur s/couvercle
 Suppentopf ohne Deckel
 Stock Pot without lid
 Panela sem tampa

Ref	€	Ø (cm)	U.Venta
54120S	66,71	20	1
54124S	82,38	24	1
54128S	100,74	28	1
54132S	159,23	32	1
54136S	172,85	36	1
54140S	218,81	40	1
54145S	284,17	45	1
* 54150S	409,61	50	1

* NO inducción - NOT induction



Olla baja con tapa

Marmite basse avec couvercle
 Gemüsetopf mit Deckel
 Low casserole with lid
 Caçarola baixa com tampa

Ref	€	Ø (cm)	h (cm)	e (mm)	L	U.Venta
54119	76,15	20	15,0	1,5	4,70	1
54123	93,48	24	20,0	1,5	9,00	1
54127	116,93	28	22,0	1,5	13,50	1
54131	153,14	32	26,0	1,5	20,00	1
54135	172,23	36	29,0	1,5	29,50	1
54139	234,79	40	32,0	2,0	40,00	1

Olla Baja sin tapa

Marmite basse s/couvercle
 Gemüsetopf ohne Deckel
 Low stock pot without lid
 Panela baixa sem tampa

Ref	€	Ø (cm)	U.Venta
54119S	61,94	20	1
54123S	76,46	24	1
54127S	97,53	28	1
54131S	129,38	32	1
54135S	143,49	36	1
54139S	202,73	40	1



Paeliera con tapa

Plat rond avec couvercle
 Planne mit Deckel
 Round dish with lid
 Paelheira com tampa

Ref	€	Ø (cm)	h (cm)	e (mm)	L	U.Venta
54636	143,07	36	7,0	1,5	7,00	1
54640	174,09	40	8,0	1,5	10,00	1
54645	201,59	45	8,5	2,0	12,00	1
* 54650	254,40	50	9,0	2,0	17,00	1

* NO inducción - NOT induction

Paeliera sin tapa

Plat rond s/couvercle
 Planne ohne Deckel
 Round dish without lid
 Paelheira sem tampa

Ref	€	Ø (cm)	U.Venta
54636S	113,19	36	1
54640S	140,37	40	1
54645S	162,89	45	1
* 54650S	208,23	50	1

* NO inducción - NOT induction



Cazo Recto

Casserole
 Stielkasserolle, fach
 Saucepan
 Caçarola direita

Ref	€	Ø (cm)	h (cm)	e (mm)	L	U.Venta
54212	36,31	12	7,0	1,2	0,75	1
54214	38,39	14	7,5	1,2	1,10	1
54216	40,57	16	8,0	1,5	1,60	1
54218	44,41	18	9,0	1,5	2,25	1
54220	49,90	20	10,0	1,5	2,90	1
* 54224	65,67	24	10,0	1,5	4,25	1
* 54228	75,84	28	11,0	1,5	6,70	1

* Con asa - With handle



Cazo Recto Alto

Casserole haute
 Stielkasserolle
 Deep saucepan
 Caçarola alta direita

Ref	€	Ø (cm)	h (cm)	e (mm)	L	U.Venta
54217	42,64	16	11,0	1,5	2,20	1
54219	50,01	18	12,0	1,5	3,00	1
54221	52,71	20	13,0	1,5	4,00	1
* 54225	75,22	24	14,0	1,5	6,70	1
* 54229	88,50	28	17,5	1,5	10,70	1

* Con asa - With handle

Cazo Francés

Casserole Française
 Stielkasserolle, französisch
 French sautépan
 Francês caçarola direita



Ref	€	Ø (cm)	h (cm)	e (mm)	L	U.Venta
54225N	64,33	24	12,0	1,5	5,40	1
54229N	82,59	28	14,0	1,5	8,60	1

Cazo cónico

Sautase conique
 Sautéuse, Kónisch
 Conical sauté pan
 Caçarola cônica



Ref	€	Ø (cm)	h (cm)	e (mm)	L	U.Venta
55216	40,57	16	6,0	1,5	1,00	1
55220	44,82	20	6,5	1,5	1,60	1
55224	52,39	24	7,5	1,5	2,70	1

Sautex

Sauteuse
 Sautéuse
 Sautéuse
 Frigideira



Ref	€	Ø (cm)	h (cm)	e (mm)	L	U.Venta
* 54621	48,45	20	6,5	1,5	1,80	1
54625	58,72	24	6,5	1,5	2,70	1
54629	72,21	28	7,0	1,5	4,00	1
54633	90,47	32	8,5	1,5	4,70	1
54637	108,94	36	10,0	1,5	7,00	1

* Ø20 NO ass - NOT handle

Tapa

Couvercle
 Deckel
 Lid
 Tampa



Ref	€	Ø (cm)	U.Venta
54916	13,59	16	1
54920	14,73	20	1
54924	16,81	24	1
54928	19,19	28	1
54932	23,45	32	1
54936	28,43	36	1
54940	32,06	40	1
54945	36,73	45	1
54950	43,68	50	1

CHEF-CLASSIC



Toda la pieza (cuerpo, asas y mangos) fabricada en Acero Inoxidable 18/10.
Fondo Termofusor (Inox 18/10 - Aluminio - Inox). Espesor 0,7 - 1,2 mm.
Tapas diseñadas para el ahorro energético.
Apta para todos los tipos de cocina (incluida inducción y horno).
* Excepto Ø60.
Acabado mate interior y exterior.
Máxima garantía en cuanto a resistencia, durabilidad e higiene.

Toute la pièce (corps, poignées et manches) est fabriquée en acier inoxydable 18/10.
Fond thermo-diffuseur (Inox 18/10 - Aluminium - Inox).
Épaisseur 0,7 - 1,2 mm. Couvercles conçus pour une économie d'énergie.
Compatible avec tous les types de cuisinières (y compris induction et four).
* Excepté Ø60.
Finition mate intérieure et extérieure.
Garantie maximale en termes de résistance, de durabilité et d'hygiène.

Ganzes Stück (Topf, Griffe und Stiele) aus rostfreiem Stahl 18/10.
Wärmeleitender Boden (Edelstahl 18/10 - Aluminium - Edelstahl).
0,7 - 1,2 mm dick. Energieeffizient geformte Deckel.
Für alle Herdarten geeignet (inkl. Induktion und Ofen) * mit Ausnahme von Ø60.
Innen und außen salmiert.
Garantiert robust, langlebig und hygienisch.

The whole product (body, handles and tops) is made in 18/10 stainless steel.
Heat diffuser bottom (18/10 stainless steel - Aluminium - Stainless).
Thickness 0.7 - 1.2 mm. Covers designed for saving energy.
Suitable for all types of cooking surfaces (including induction and the oven).
* Except Ø60.
Interior and exterior matte finish.
Maximum guarantee in terms of resistance, durability and hygiene.

Peça fabricada inteiramente (corpo, asas e mangos) em aço inoxidável 18/10.
Fundo Termofusor (Inox 18/10 - Alumínio - Inox).
Espessura 0,7 - 1,2 mm. Tampas concebidas para poupar energia.
Apta para todos os tipos de fogões (incluindo placas de indução e forno).
* Excepto Ø60.
Acabamento mate interior e exterior.
Máxima garantia de resistência, durabilidade e higiene.

Cacerola con tapa

Faitout avec couvercle
Bratentopf mit Deckel
Casserole with lid
Caçarola com tampa

Ref	€	Ø (cm)	h (cm)	e (mm)	L	U.Venta
50016	42,95	16	8,0	0,7	1,60	1
50020	49,49	20	9,0	0,7	2,80	1
50024	56,86	24	9,5	0,8	4,25	1
50028	78,44	28	11,0	0,8	6,75	1
50032	95,76	32	12,5	0,8	10,00	1
50036	130,62	36	14,0	1,0	14,20	1
50040	152,93	40	15,5	1,0	19,40	1
50045	178,66	45	17,0	1,0	27,00	1
50050	247,86	50	20,0	1,0	38,20	1
+50060	351,61	60	25,0	1,2	70,00	1

* NO inducción · NOT induction

Cacerola sin tapa

Faitout sans couvercle
Bratentopf ohne Deckel
Casserole without lid
Caçarola sem tampa

Ref	€	Ø (cm)	U.Venta
50016S	34,13	16	1
50020S	39,63	20	1
50024S	45,34	24	1
50028S	65,88	28	1
50032S	81,44	32	1
50036S	111,64	36	1
50040S	130,00	40	1
50045S	152,72	45	1
50050S	216,94	50	1
+50060S	313,64	60	1

* NO inducción · NOT induction



Cacerola Vapor

Panier vapeur
Dampfkoch-Aussatz o/Untertopf
Steam casserole
Caçarola a vapor

Ref	€	Ø (cm)	h (cm)	e (mm)	U.Venta
50428	50,22	28	11,0	0,8	1
50432	55,40	32	12,5	0,8	1



Cacerola alta con tapa

Braisiere avec couvercle
Fleischtopf mit Deckel
Deep casserole with lid
Caçarola alta com tampa

Ref	€	Ø (cm)	h (cm)	e (mm)	L	U.Venta
50017	44.51	16	11,0	0,7	2,20	1
50021	53.22	20	13,0	0,7	4,00	1
50025	63.50	24	14,0	0,8	6,75	1
50029	81.55	28	17,5	0,8	10,00	1
50033	104.48	32	18,0	0,8	14,40	1
50037	142.86	36	21,5	1,0	21,80	1
50041	173.06	40	24,5	1,0	30,70	1
50046	199.82	45	27,5	1,0	43,70	1
50051	286.77	50	30,0	1,2	58,80	1
*50061	401.62	60	35,0	1,2	98,00	1

* NO inducción · NOT induction

Cacerola alta sin tapa

Braisiere sans couvercle
Fleischtopf ohne Deckel
Deep casserole without lid
Caçarola alta sem tampa

Ref	€	Ø (cm)	U.Venta
50017S	35.69	16	1
50021S	43.37	20	1
50025S	51.98	24	1
50029S	68.99	28	1
50033S	90.16	32	1
50037S	123.77	36	1
50041S	150.13	40	1
50046S	173.89	45	1
50051S	255.85	50	1
*50061S	363.75	60	1

* NO inducción · NOT induction

**Olla recta con tapa**

Marmite traiteur avec couvercle
Suppentopf mit Deckel
Stock pot with lid
Panela com tampa

Ref	€	Ø (cm)	h (cm)	e (mm)	L	U.Venta
50116	47.73	16	16,0	0,8	3,20	1
50120	59.24	20	20,2	0,8	6,20	1
50124	75.53	24	24,0	0,8	10,50	1
50128	102.92	28	28,0	1,0	17,20	1
50132	143.90	32	32,0	1,0	25,70	1
50136	176.38	36	36,0	1,0	36,60	1
50140	212.48	40	40,0	1,2	50,00	1
50145	272.03	45	45,0	1,2	68,30	1
50150	426.83	50	50,0	1,2	98,00	1
*50160	597.81	60	50,0	1,2	141,00	1

* NO inducción · NOT induction

Olla recta sin tapa

Marmite traiteur s/couvercle
Suppentopf ohne Deckel
Stock Pot without lid
Panela sem tampa

Ref	€	Ø (cm)	U.Venta
50116S	38.91	16	1
50120S	49.39	20	1
50124S	64.01	24	1
50128S	90.37	28	1
50132S	129.48	32	1
50136S	157.29	36	1
50140S	189.66	40	1
50145S	245.99	45	1
50150S	395.91	50	1
*50160S	559.84	60	1

* NO inducción · NOT induction

**Olla baja con tapa**

Marmite basse a/couvercle
Gemüsetopf mit Deckel
Low stock pot with lid
Panela baixa com tampa

Ref	€	Ø (cm)	h (cm)	e (mm)	L	U.Venta
50119	53.74	20	15,0	0,8	4,70	1
50123	71.69	24	20,0	0,8	9,00	1
50127	93.58	28	22,0	0,8	13,50	1
50131	136.43	32	26,0	1,0	20,80	1
50135	158.43	36	29,0	1,0	29,50	1
50139	199.93	40	32,0	1,2	40,00	1

Olla baja sin tapa

Marmite basse s/couvercle
Gemüsetopf ohne Deckel
Low stock pot without lid
Panela baixa sem tampa

Ref	€	Ø (cm)	U.Venta
50119S	42.23	20	1
50123S	59.14	24	1
50127S	79.27	28	1
50131S	117.34	32	1
50135S	135.60	36	1
50139S	175.99	40	1

**Paellera con tapa**

Plat rond a/couvercle
Pfanne mit Deckel
Round with lid
Paelheira com tampa

Ref	€	Ø (cm)	h (cm)	e (mm)	L	U.Venta
50624	53.33	24	6,0	0,8	2,70	1
50628	72.52	28	6,0	0,8	3,60	1
50632	93.89	32	6,0	0,8	5,00	1
50636	118.69	36	7,0	1,0	7,10	1
50640	136.85	40	8,0	1,0	10,00	1
50645	160.61	45	8,5	1,0	13,50	1
50650	208.43	50	9,0	1,0	17,60	1
*50660	301.39	60	9,0	1,0	25,40	1

* NO inducción · NOT induction

Paellera sin tapa

Plat rond s/couvercle
Pfanne ohne Deckel
Round dish without lid
Paelheira sem tampa

Ref	€	Ø (cm)	U.Venta
50624S	40.77	24	1
50628S	58.20	28	1
50632S	74.80	32	1
50636S	95.87	36	1
50640S	110.91	40	1
50645S	129.69	45	1
50650S	170.46	50	1
*50660S	251.80	60	1

* NO inducción · NOT induction





Cazo Recto

Casserole
 Stielkasserolle, fach
 Saucepan
 Caçarola direita

Ref	€	Ø (cm)	h (cm)	e (mm)	L	U.Venta
50212	23,34	12	7,0	0,7	0,75	1
50214	25,11	14	7,5	0,7	1,10	1
50216	27,60	16	8,0	0,8	1,60	1
50218	29,78	18	9,0	0,8	2,20	1
50220	32,99	20	9,0	0,8	2,80	1
50224	40,67	24	9,5	0,8	4,25	1
50228	57,06	28	11,0	0,8	6,75	1



Cazo Recto Alto

Casserole haute
 Stielkasserolle, hoch
 Deep saucepan
 Caçarola alta direita

Ref	€	Ø (cm)	h (cm)	e (mm)	L	U.Venta
50217	29,47	16	11,0	0,8	2,10	1
50219	34,13	18	12,0	0,8	3,00	1
50221	38,49	20	13,0	0,8	4,00	1
50225	46,90	24	14,0	0,8	6,30	1
50229	63,81	28	17,5	0,8	10,20	1



Cazo Francés

Casserole Française
 Stielkasserolle, französisch
 French saucepan
 Francês caçarola direita

Ref	€	Ø (cm)	h (cm)	e (mm)	L	U.Venta
50225N	45,13	24	12,0	0,8	5,50	1
50229N	58,31	28	14,0	0,8	8,50	1



Baño María con fondo

Bahut avec fond
 Bain Marie Topf
 Double boiler with bottom
 Banho-Maria com fundo

Ref	€	Ø (cm)	h (cm)	e (mm)	L	U.Venta
50717	33,93	16	16,0	0,8	3,20	1
50721	44,09	20	20,0	0,8	6,20	1



Cazo cónico

Sautase conique
 Sautouse, Konisch
 Conical saute pan
 Caçarola cónica

Ref	€	Ø (cm)	h (cm)	e (mm)	L	U.Venta
51216	33,51	16	6,0	1,0	1,00	1
51218	35,28	18	6,0	1,0	1,20	1
51220	36,83	20	6,5	1,0	1,60	1
51222	40,15	22	7,0	1,0	2,10	1
51224	44,09	24	7,5	1,0	2,70	1



Sautex

Sautouse
 Sautouse
 Sautouse
 Fngideira

Ref	€	Ø (cm)	h (cm)	e (mm)	L	U.Venta
50625	39,32	24	6,5	0,8	2,70	1
50629	54,37	28	7,0	0,8	4,00	1
50633	61,52	32	8,5	0,8	4,70	1
50637	88,71	36	10,0	1,0	7,00	1



Rustiders

Piat à rôtir
 Bratpfanne
 Roaster
 Assadeira

Ref	€	cm	h (cm)	e (mm)	U.Venta
50540	98,15	40x30	8,0	1,0	1
50550	130,00	50x40	8,0	1,0	1
50560	163,72	60x45	8,0	1,0	1
50570	187,17	70x45	9,5	1,0	1



Tapa

Couvercle
 Deckel
 Lid
 Tampa

Ref	€	Ø (cm)	U.Venta
50916	8,82	16	1
50918	9,86	18	1
50920	11,52	20	1
50924	12,55	24	1
50928	14,32	28	1
50932	19,09	32	1
50936	22,83	36	1
50940	25,94	40	1
50945	30,92	45	1
50950	37,97	50	1
50960	49,59	60	1



Máxima garantía en resistencia y durabilidad

Maximum guarantee in resistance and durability



Toda la pieza (cuerpo, asas y mangos) fabricada en Acero Inoxidable.
Fondo Termodifusor (Inox 18/10 - Aluminio - Inox). Espesor 0,6 - 1 mm.
Tapas diseñadas para el ahorro energético.
Apta para todos los tipos de cocinas (incluida inducción y horno).
Acabado interior mate y exterior brillo-mate.
Máxima garantía en cuanto a resistencia, durabilidad e higiene.

Toute la pièce (corpe, poignées et manches) est fabriquée en acier inoxydable.
Fond thermo-diffuseur (Inox 18/10 - Aluminium - Inox). Épaisseur 0,6 - 1 mm.
Couvercles conçus pour une économie d'énergie.
Compatible avec tous les types de cuisinières (y compris induction et four).
Finition mate intérieur et brillant-mate extérieur.
Garantie maximale en termes de résistance, de durabilité et d'hygiène.

Ganzes Stück (Topf, Griffe und Stiele) aus rostfreiem Stahl 18/10.
Wärmeleitender Boden (Edelsahl 18/10 - Aluminium - Edelsahl), 0,6 - 1 mm dick.
Energiesparende Deckel.
Für alle Herdarten geeignet (inkl. Induktion und Ofen).
Innen satiniert und außen Hellglanz- und satiniert.
Garantiert robust, langlebig und hygienisch.

The whole product (body, handles and grips) is made in stainless steel.
Heat diffuser bottom (18/10 stainless steel - Aluminium - Stainless). Thickness 0,6 - 1 mm.
Covers designed for saving energy.
Suitable for all types of cooking surfaces (including induction and the oven).
Interior matte finish and exterior brightness-matte finish.
Maximum guarantee in terms of resistance, durability and hygiene.

Peça fabricada inteiramente (corpo, asas e mangos) em aço inoxidável.
Fundo Termodifusor (Inox 18/10 - Alumínio - Inox). Espessura 0,6 - 1 mm.
Tampas desenhadas para poupar energia.
Apta para todos os tipos de fogões (incluindo placas de indução e forno).
Acabamento interior mate e exterior brilho-mate.
Máxima garantia de resistência, durabilidade e higiene.



Cacerola sin tapa
Faitout sans couvercle
Bräntopf ohne Deckel
Casserole without lid
Caçarola sem tampa

Ref	€	Ø (cm)	h (cm)	e (mm)	L	U.Venta
57016	26,04	16	8,0	0,6	1,60	1
57020	32,06	20	9,0	0,6	2,80	1
57024	35,17	24	9,5	0,7	4,25	1
57028	55,71	28	11,0	0,7	6,75	1
57032	66,30	32	12,5	0,7	10,00	1
57036	95,45	36	14,5	0,7	14,20	1
57040	108,63	40	15,5	0,9	19,40	1



Cacerola alta sin tapa
Braisiers sans couvercle
Fleischtopf ohne Deckel
Deep casserole without lid
Caçarola alta sem tampa

Ref	€	Ø (cm)	h (cm)	e (mm)	L	U.Venta
57017	27,81	16	11,0	0,6	2,20	1
57021	33,82	20	13,0	0,6	4,00	1
57025	41,40	24	15,0	0,7	7,00	1
57029	60,80	28	17,5	0,7	10,00	1
57033	73,56	32	18,0	0,7	14,40	1
57037	104,58	36	21,5	0,9	21,80	1
57041	128,34	40	24,5	0,9	30,70	1



Olla recta sin tapa

Marmite traiteur sans couvercle
Suppentopf ohne Deckel
Stock pot without lid
Panela sem tampa

Ref	€	Ø (cm)	h (cm)	e (mm)	L	U.Venta
57116	31,75	16	16,0	0,7	3,20	1
57120	37,14	20	20,0	0,7	6,20	1
57124	52,19	24	24,0	0,7	10,50	1
57128	77,19	28	25,5	0,9	16,50	1
57132	107,69	32	32,0	0,9	25,70	1
57136	135,19	36	36,0	0,9	36,60	1
57140	166,52	40	40,0	1,0	50,00	1



Paellera sin tapa

Plat rond sans couvercle
Planne ohne Deckel
Round without lid
Paelheira sem tampa

Ref	€	Ø (cm)	h (cm)	e (mm)	L	U.Venta
57624	34,45	24	6,5	0,7	3,00	1
57628	47,83	28	6,5	0,7	4,00	1
57632	61,01	32	7,0	0,7	5,00	1
57636	78,33	36	7,0	0,9	7,10	1
57640	90,26	40	8,0	0,9	10,00	1



Cazo Recto

Casserole
Stielkasserolle, flach
Saucepan
Caçarola dreite

Ref	€	Ø (cm)	h (cm)	e (mm)	L	U.Venta
57212	19,82	12	7,0	0,6	0,75	1
57214	21,17	14	7,5	0,6	1,10	1
57216	22,51	16	8,0	0,6	1,60	1
57218	24,69	18	8,5	0,6	2,00	1
57220	27,60	20	9,0	0,6	2,80	1
57224	35,59	24	9,5	0,7	4,25	1



Cazo Recto Alto

Casserole haute
Stielkasserolle, hoch
Deep saucepan
Caçarola alta dreite

Ref	€	Ø (cm)	h (cm)	e (mm)	L	U.Venta
57217	24,69	16	11,0	0,6	2,10	1
57219	28,74	18	12,0	0,6	3,00	1
57221	32,68	20	13,0	0,6	4,00	1
57225	44,82	24	15,0	0,7	6,50	1



Baño Maria con fondo

Bahut avec fond
Bain Marie Topf
Double boiler with bottom
Banho-Maria com fundo

Ref	€	Ø (cm)	h (cm)	e (mm)	L	U.Venta
57717	28,95	16	16,0	0,7	3,20	1
57721	38,91	20	20,0	0,7	6,20	1



Sautex

Sauteuse
Sauteuse
Sauteuse
Frigideira

Ref	€	Ø (cm)	h (cm)	e (mm)	L	U.Venta
57625	32,68	24	6,5	0,7	2,70	1
57629	49,39	28	6,5	0,7	4,00	1



Tapa

Couvercle
Deckel
Lid
Tampa

Ref	€	Ø (cm)	U.Venta
57916	9,34	16	1
57920	11,83	20	1
57924	12,87	24	1
57928	14,84	28	1
57932	19,19	32	1
57936	23,55	36	1
57940	26,66	40	1

CHEF-ALUMINIO



Aluminio puro (99,5%)

Made in pure (99,5%) aluminium



Cuerpo fabricado en Aluminio puro (99,5%).
Asas y mangos atérmicos en tubo de acero inoxidable 18/10.
Espesor 2,5 - 5 mm.
Tapas diseñadas para el ahorro energético.
Apta para todos los tipos de cocina (excepto inducción).
Acabado mate interior y exterior mate lijado.
Máxima garantía en cuanto a resistencia, durabilidad e higiene.

Corps fabriqué en aluminium pur (99,5%).
Poignées et manches athermiques en tube d'acier inoxydable 18/10.
Épaisseur 2,5 - 5 mm.
Couvercles conçus pour une économie d'énergie.
Compatible avec tous les types de cuisinières (excepté l'induction).
Finition intérieure mate et extérieure mate brossé.
Garantie maximale en termes de résistance, de durabilité et d'hygiène.

Körper aus reinem Aluminium (99,5%).
Griffe und Steile aus hitzeabweisendem Edelstahlrohr 18/10.
2,5 - 5 mm dick.
Energiesparende Deckel.
Für alle Herdarten geeignet (außer Induktion).
Innen und außen matt glänzend.
Garantiert robust, langlebig und hygienisch.

Body made in pure (99,5%) aluminium.
Heatproof handles and grips in a 18/10 stainless steel tube.
Thickness 2.5 - 5 mm.
Covers designed for saving energy.
Suitable for all types of cooking surfaces (except induction).
Interior matte finish and exterior sanded matte finish.
Maximum guarantee in terms of resistance, durability and hygiene.

Corpo fabricado em alumínio puro (99,5%).
Asas e mangos térmicos em tubo de aço inoxidável 18/10.
Espessura 2,5 - 5 mm.
Tampas desenhadas para poupar energia.
Apta para todos os tipos de fogões (exceto placas de indução).
Acabamento mate interior e exterior mate lixado.
Máxima garantia de resistência, durabilidade e higiene.



Cacerola con tapa
Braisière à couvercle
Bratentopf mit Deckel
Casserole with lid
Caçarola com tampa

Ref	€	Ø (cm)	h (cm)	e (mm)	L	U.Venta
20020	49,77	20	8,0	2,5	2,50	1
20024	45,44	24	9,5	2,5	4,30	1
20028	54,58	28	11,0	2,5	6,75	1
20030	58,83	30	11,5	2,5	8,15	1
20032	62,87	32	12,0	2,5	9,65	1
20034	68,37	34	13,0	3,0	11,80	1
20036	72,52	36	14,0	3,0	14,25	1
20038	81,24	38	15,0	3,0	17,00	1
20040	85,70	40	16,0	3,0	21,10	1
20045	102,40	45	18,0	3,5	28,00	1
20050	122,43	50	21,0	3,5	41,00	1
20060	174,30	60	25,0	4,5	70,00	1



Cacerola Alta con tapa
Braisière avec couvercle
Fleischtopf mit Deckel
Deep casserole with lid
Caçarola alta com tampa

Ref	€	Ø (cm)	h (cm)	e (mm)	L	U.Venta
20021	44,30	20	13,0	2,5	4,10	1
20025	50,84	24	15,0	2,5	6,80	1
20029	58,72	28	17,0	2,5	10,45	1
20031	64,01	30	18,0	2,5	12,70	1
20033	74,18	32	19,0	3,0	15,25	1
20035	79,99	34	21,0	3,0	18,05	1
20037	81,96	36	22,0	3,0	22,40	1
20039	88,91	38	23,0	3,0	26,10	1
20041	102,40	40	25,0	3,5	31,40	1
20046	116,93	45	28,0	4,5	45,00	1
20051	155,11	50	31,0	4,5	60,00	1
20061	205,84	60	37,0	4,5	104,00	1



Olla Recta con tapa

Marmite traiteur a/couvercle
Suppentopf mit Deckel
Stock pot with lid
Panela com tampa

Ref	€	Ø (cm)	h (cm)	e (mm)	L	U.Venta
20120	50,42	20	20,0	2,5	6,30	1
20124	58,83	24	24,0	2,5	10,85	1
20128	73,97	28	28,0	3,0	17,25	1
20130	80,93	30	30,0	3,0	21,20	1
20132	89,12	32	32,0	3,0	25,75	1
20134	98,56	34	34,0	3,5	30,90	1
20136	105,93	36	36,0	3,5	36,65	1
20138	113,30	38	38,0	3,5	43,10	1
20140	126,99	40	40,0	4,0	50,30	1
20145	156,66	45	45,0	4,5	72,00	1
20150	176,48	50	50,0	4,5	100,00	1
20160	257,40	60	55,0	5,0	155,50	1



Poellera

Plaf rond
Pfanne
Round
Paelheira

Ref	€	Ø (cm)	h (cm)	e (mm)	L	U.Venta
20628	34,96	28	7,0	2,5	4,30	1
20630	37,14	30	6,5	2,5	4,75	1
20632	39,74	32	7,0	2,5	5,50	1
20634	42,02	34	7,0	2,5	6,35	1
20636	44,41	36	7,5	2,5	7,45	1
20638	45,03	38	7,5	3,0	8,60	1
20640	53,02	40	8,0	3,0	10,05	1
20645	58,00	45	8,0	3,0	12,50	1
20650	67,54	50	8,0	3,0	15,50	1
20660	96,59	60	10,0	3,5	28,00	1



Cazo Recto

Casserole
Stielkasserolle, flach
Saucepan
Caçarola direita

Ref	€	Ø (cm)	h (cm)	e (mm)	L	U.Venta
20216	22,72	16	7,0	2,5	1,40	1
20220	27,18	20	8,0	2,5	2,50	1
20224	30,92	24	9,5	2,5	4,30	1
20228	36,73	28	11,0	2,5	6,80	1



Cazo Recto Alto

Casserole haute
Stielkasserolle, hoch
Deep saucepan
Caçarola alta direita

Ref	€	Ø (cm)	h (cm)	e (mm)	L	U.Venta
20217	26,87	16	11,0	2,5	2,20	1
20221	31,23	20	13,0	2,5	4,10	1
20225	36,31	24	15,0	2,5	6,80	1
20229	42,02	28	17,0	2,5	10,50	1



Cazo Bombado

Casserole bombée
Kasserolle, Bauchig
Rounded saucepan
Caçarola bojuda

Ref	€	Ø (cm)	h (cm)	e (mm)	L	U.Venta
21216	22,93	16	8,0	2,5	1,50	1
21220	27,39	20	10,0	2,5	2,50	1
21224	32,47	24	12,0	2,5	4,00	1
21228	38,39	28	14,0	2,5	6,50	1



Pote cilíndrico

Pot-cylindrique
Milchtöpf
Cylindrical pot
Caneca cilíndrica

Ref	€	Ø (cm)	h (cm)	e (mm)	L	U.Venta
20716	28,84	16	16,0	2,5	3,20	1
20720	33,82	20	20,0	2,5	6,30	1



Rustidera con asa abatible

Plat à rotir anse tombante
Bratpfanne mit Fallgriffen
Roaster moving handle
Assadeira com asa abatível

Ref	€	cm	h (cm)	e (mm)	L	U.Venta
20540A	45.03	40x30	6,2	2,5	7,45	1
20545A	48.35	45x32	6,2	2,5	10,40	1
20550A	60.69	50x35	7,0	3,0	12,60	1
20555A	65.88	55x37	7,7	3,0	16,30	1
20560A	70.86	60x40	7,7	3,0	18,95	1
20565A	79.27	65x43	7,9	3,0	24,30	1
20570A	83.83	70x45	9,0	3,0	28,65	1



Rustidera con asa fija

Plat à rotir anse fixe
Bratpfanne, m. feststehenden Griffen
Roaster fix handle
Assadeira com asa fixa

Ref	€	cm	h (cm)	e (mm)	L	U.Venta
20540F	45.03	40x30	6,2	2,5	7,45	1
20545F	48.35	45x32	6,2	2,5	10,40	1
20550F	60.69	50x35	7,0	3,0	12,60	1
20555F	65.88	55x37	7,7	3,0	16,30	1
20560F	71.28	60x40	7,7	3,0	18,95	1
20565F	79.27	65x43	7,9	3,0	24,30	1
20570F	83.83	70x45	9,0	3,0	28,65	1



Hervidor de pescado

Poissonniere avec grille
Fischkessel mit Einsatz
Fish kettle with grill and lid
Peixeira

Ref	€	cm	h (cm)	e (mm)	L	U.Venta
20470	175.44	70x22	20,80	2,5	14,0	1



Colador 4 sectores c/cacerola y tapa

Cuit-pâtes 4 compartiments complet
Teigwarenkochtopf mit 4 Einsätzen und Deckel
4 segmented colander with casserole and lid
Coader 4 sectores com caçarola e tampa

Ref	€	Ø (cm)	h (cm)	e (mm)	U.Venta
20337	404.21	36	17,5	2,5	1
20341	486.69	40	19,5	2,5	1

Bandeja horno

Plaque à four
Backblech
Oven tray
Bandeja forno



Ref	€	cm	h (cm)	e (mm)	U.Venta
20551	33.82	50x35	2,0	2,5	1
20561	41.29	60x40	2,0	2,5	1

Tapa

Couvercle
Deckel
Lid
Tampa



Ref	€	Ø (cm)	U.Venta
20920	12.14	20	1
20924	12.97	24	1
20928	15.67	28	1
20930	16.39	30	1
20932	18.16	32	1
20934	18.57	34	1
20936	19.92	36	1
20938	20.75	38	1
20940	23.14	40	1
20945	25.11	45	1
20950	29.88	50	1
20960	35.28	60	1

Baterías Domésticas
Household Cookware

#CocinaConLacor





Fabricadas en acero inoxidable 18/10 de la mejor calidad.
 Asas y mangos ergonómicos de acero inoxidable fundido.
 Máxima garantía en cuanto a resistencia, durabilidad e higiene.
 Acabado interior y exterior lijado satinado.
 Marcaje de capacidades en el interior (Litros).
 Fondo termodifusor sandwich (Inox 18/10 - Aluminio - Inoxidable).
 Distribución rápida y uniforme del calor.
 Aptas para todos los fuegos (incluido inducción y horno).

Fabriquées en acier inoxydable 18/10 de la meilleure qualité.
 Poignées et manches ergonomiques en acier inoxydable fondu.
 Garantie maximale en termes de résistance, de durabilité et d'hygiène.
 Finition intérieure et extérieure en polissage satiné.
 Marquage des capacités à l'intérieur (Litres).
 Fond thermofuseur sandwich (Inox 18/10 - Aluminium - Inoxydable).
 Distribution rapide et uniforme de la chaleur.
 Aptes pour tous les types de feux (y compris l'induction et le four).

Aus Edelstahl 18/10 bester Qualität.
 Ergonomische Griffe und Stiele aus gegossenem Edelstahl.
 Garantiert robust, langlebig und hygienisch.
 Außen- und Innenseite in mattem Schliff.
 Füllstandsanzeige (in Liter) auf der Innenseite.
 Wärmeleitender Sandwichboden (Edelstahl 18/10 - Aluminium - Edelstahl).
 Gleichmäßige und schnelle Wärmeverteilung.
 Für alle Herdarten geeignet (inkl. Induktion und Ofen).

Maximum guarantee in resistance, durability and hygiene.
 Ergonomic handles and grips made of cast stainless steel.
 Maximum guarantee in terms of resistance, durability and hygiene.
 Glossy sanded interior and exterior finish.
 Capacity markings on the inside (Litres).
 Heat diffusing sandwiched base (18/10 Stainless Steel - Aluminium - St. Steel).
 Quick and even heat distribution.
 Suitable for all types of cookers (including induction hobs and ovens).

Fabricadas em aço inoxidável 18/10 da melhor qualidade.
 Asas e cabos ergonómicos em aço inoxidável fundido.
 Máxima garantia de resistência, durabilidade e higiene.
 Acabamento interior e exterior lixado acetinado.
 Indicação de capacidades no interior (em litros).
 Fundo termodifusor tipo sanduíche (Inox 18/10 - Alumínio - Inoxidável).
 Distribuição rápida e uniforme do calor.
 Aptas para todo o tipo de fogões (incluindo placas de indução e fornos).



Marcajes de capacidad
 Capacity markings.



Cacerola con tapa
 Faitout avec couvercle
 Bratentopf mit Deckel
 Casseroles with lid
 Caçarola com tampa

Ref	€	Ø (cm)	h (cm)	L	U.Venta
45016	39,01	16	7,5	1,50	1
45018	42,33	18	8,5	2,00	1
45020	46,27	20	9,5	3,00	1
45022	52,50	22	10,5	4,00	1
45024	57,89	24	11,5	5,00	1
45026	64,01	26	12,5	6,50	1
45028	69,20	28	12,5	7,50	1



Olla con tapa
 Marmite avec couvercle
 Fleischtopf mit Deckel
 Stock pot with lid
 Panela com tampa

Ref	€	Ø (cm)	h (cm)	L	U.Venta
45116	42,85	16	13,0	2,50	1
45118	45,86	18	14,0	3,50	1
45120	51,88	20	15,5	4,80	1
45122	56,44	22	15,5	5,50	1
45124	62,87	24	16,0	7,00	1
45126	68,68	26	16,0	8,00	1
45128	78,02	28	17,0	10,00	1

Cazo recto

Casserole
Stielkasserolle, fach
Saucepan
Caçarola direita



Ref	€	Ø (cm)	h (cm)	L	U.Venta
45214	28,01	14	7,5	1,00	1
45216	30,09	16	7,5	1,50	1
45218	33,62	18	8,5	2,00	1
45220	38,08	20	9,5	3,00	1

Tartera con tapa

Plat rond avec couvercle
Pfanne mit Deckel
Round dish with lid
Tarteira com tampa



Ref	€	Ø (cm)	h (cm)	L	U.Venta
45624	53,33	24	6,5	2,80	1
45626	58,41	26	6,5	3,00	1
45628	63,18	28	6,5	4,00	1

Tapa

Couvercle
Deckel
Lid
Tampa



Ref	€	Ø (cm)	U.Venta
45916	10,48	16	1
45918	11,00	18	1
45920	11,83	20	1
45922	12,76	22	1
45924	14,01	24	1
45926	15,04	26	1
45928	16,60	28	1

Sartén

Poêle
Pfanne
Frying pan
Sertã



Ref	€	Ø (cm)	h (cm)	e (mm)	U.Venta
45420	26,56	20	5,5	0,6	1
45424	31,75	24	6,0	0,6	1
45428	37,25	28	6,5	0,6	1

Sartén antiadherente

Poêle antiadherent
Pfanne, Antihaft
Frying-pan, non-stick
Sertã anti-aderente



Ref	€	Ø (cm)	h (cm)	e (mm)	U.Venta
45320	31,23	20	5,5	0,6	1
45324	38,18	24	6,0	0,6	1
45328	45,75	28	6,5	0,6	1



Antiadherente QuanTanium® reforzado con partículas de titanio; libre de materiales tóxicos y pesados, ecológico y libre de PFOA.

Antiadhésif QuanTanium® renforcé avec des particules de titane : sans matériaux toxiques ni métaux lourds, écologique et sans PFOA.

Antihaftbeschichtung QuanTanium® mit Titanbeimischung, frei von Giftstoffen und Schwermetallen, umweltfreundlich und ohne PFOA.

QuanTanium® non-stick reinforced with titanium particles, free from toxic and heavy materials, environmentally friendly and PFOA-free.

Material antiaderente QuanTanium® reforçado com partículas de titânio, ecológico e livre de PFOA. Não contém materiais tóxicos e pesados.



High release topcoat

Partially reinforced midcoat

Reinforced primer (titanium-based particles)

Metal substrate



PROFESIONAL



Toda la pieza (cuerpo, asas y mangos) fabricada en Acero Inoxidable 18/10.
 Favorece una distribución rápida y homogénea del calor.
 Acabado pulido brillante exterior y lijado mate interior.
 Máxima garantía en cuanto a resistencia, durabilidad e higiene.
 Apta para todo tipo de cocinas (incluido inducción y horno).
 Fondo Termodifusor sándwich (Inox 18/10 - Aluminio - Inox).

Toute la pièce (corps, poignées et manches) est fabriquée en acier inoxydable 18/10.
 Favorise une distribution rapide et homogène de la chaleur.
 Finition extérieure polie brillante et intérieure polie mate.
 Garantie maximale en termes de résistance, de durabilité et d'hygiène.
 Compatible avec tout type de cuisinières (y compris induction et four).
 Fond thermo diffuseur sandwich (Inox 18/10 Aluminium - Inox).

Ganzes Stück (Topf, Griffe und Stiele) aus rostfreiem Stahl 18/10.
 Fördert eine gleichmäßige und schnelle Wärmeverteilung.
 Hochglanzpolierte Außen- und glänzend matte Innenseite.
 Garantiert robust, langlebig und hygienisch.
 Für alle Herdarten geeignet (inkl. Induktion und Ofen).
 Wärmeleitender Sandwichboden (Edelstahl 18/10 - Aluminium - Edelstahl).

The whole product (body, handles and grips) is made in 18/10 stainless steel.
 It favours quick and homogeneous heat distribution.
 Exterior glossy, polished finish and sanded matte interior.
 Maximum guarantee in terms of resistance, durability and hygiene.
 Suitable for all types of cooking surfaces (including induction and the oven).
 Sandwich heat diffuser (18/10 stainless steel - Aluminium - Stainless steel).

Peça fabricada inteiramente (corpo, asas e mangos) em aço inoxidável 18/10.
 Favorece a distribuição rápida e homogênea do calor.
 Acabamento exterior brilhante polido, e interior mate lixado.
 Máxima garantia de resistência, durabilidade e higiene.
 Apta para todo o tipo de fogões (incluindo placas de indução e forno).
 Fundo termodifusor tipo sanduíche (Inox 18/10 - Alumínio - Inox).

Cacerola con tapa

Faitout à/couvercle
 Bratentopf mit Deckel
 Casserole with lid
 Caçarola com tampa



Ref	€	Ø (cm)	h (cm)	L	U.Venta
72016	43,58	16	8,0	1,50	1
72020	51,05	20	8,5	2,50	1
72024	59,76	24	9,5	3,50	1
72028	76,46	28	11,0	6,50	1
72032	103,75	32	12,5	9,00	1

Olla con tapa

Marmite à/couvercle
 Fleischtopf mit Deckel
 Stock pot with Lid
 Panela com tampa



Ref	€	Ø (cm)	h (cm)	L	U.Venta
72116	47,21	16	13,0	2,50	1
72120	54,57	20	14,5	4,50	1
72124	65,67	24	15,0	6,50	1
72128	85,28	28	17,0	10,00	1
72132	108,94	32	17,5	13,50	1

Olla super alta con tapa

Marmite S. Haute à/couvercle
 Hoher Fleischtopf mit Deckel
 Deep Stock pot with Lid
 Panela super alta com tampa



Ref	€	Ø (cm)	h (cm)	L	U.Venta
72125	71,69	24	20,0	9,00	1
72129	93,79	28	22,0	13,50	1

Cazo Recto

Casserole
 Svielcasserole, flach
 Saucepan
 Caçarola direita



Ref	€	Ø (cm)	h (cm)	L	U.Venta
72214	23,45	14	7,5	1,00	1
72216	26,46	16	8,0	1,50	1
72218	28,43	18	8,5	2,00	1
72220	32,06	20	8,5	2,50	1

Colador esférico

Passoire à queue
Seiher, mit Stiel
Strainer
Coador esférico



Ref	€	Ø (cm)	h (cm)	U.Venta
72318	28,01	18	8,5	1

Escurridera

Passoire sur pied
Abtropfchüssel
Colander with stand
Escorredor



Ref	€	Ø (cm)	h (cm)	U.Venta
72324	43,05	24	11,0	1

Cacerola vapor

Panier vapeur
Dampkoch-Aufsatz
Steam casserole
Caçarola a vapor



Ref	€	Ø (cm)	h (cm)	L	U.Venta
72420	35,21	20	8,5	2,50	1
72424	44,09	24	9,5	3,50	1
72428	49,07	28	11,0	6,50	1

Cuecepastas sin tapa

Cuit-pâle sans couvercle
Nudelkoch-Einsatz ohne Deckel
Pasta cooker without lid
Coze-massas sem tampa



Ref	€	Ø (cm)	h (cm)	L	U.Venta
72423	51,11	24	17,5	9,50	1

Tartera con tapa

Plat rond avec couvercle
Pfanne mit Deckel
Round dish with lid
Tarteira com tampa



Ref	€	Ø (cm)	h (cm)	L	U.Venta
72620	49,07	20	6,5	2,00	1
72624	57,89	24	7,0	3,00	1
72628	73,25	28	8,0	4,50	1
72632	95,70	32	8,0	6,00	1

Sautex

Sauteuse
Sauteuse
Sauteuse
Frigideira



Ref	€	Ø (cm)	h (cm)	L	U.Venta
72625	42,95	24	7,0	3,00	1
72629	53,74	28	8,0	4,50	1

Pote cilíndrico

Pot cylindrique
Milchtopf
Cylindrical pot
Caneca cilíndrica



Ref	€	Ø (cm)	h (cm)	L	U.Venta
72714	27,49	14	12,5	1,50	1
72716	31,13	16	13,0	2,50	1
72720	35,17	20	14,5	4,50	1

Tapa

Couvercle
Deckel
Lid
Tampa



Ref	€	Ø (cm)	U.Venta
72916	11,83	16	1
72918	12,45	18	1
72920	14,32	20	1
72924	16,60	24	1
72928	21,48	28	1
72932	23,24	32	1

Cacerola Ø16-20-24 cm
Olla Ø16-20 cm
Cazo Ø14-16 cm
Pote Ø14 cm

Bateria 8 piezas

Batterie 8 pcs.
8-Tig-Batterie
Battery 8 pcs.
Bateria 8 pcs.

Ref	€	U.Venta
72000	333,66	1





Toda la pieza (cuerpo y asas) fabricada en acero inoxidable 18/10. Máxima garantía en cuanto a resistencia, durabilidad e higiene. El diseño de cuerpos bombeados proporciona mayor capacidad. Marcaje de capacidades en el interior (Litros). Fondo termodifusor sandwich (Inox 18/10 - Aluminio - Inoxidable). Distribución rápida y uniforme del calor. Apta para todos los fuegos (incluido inducción y horno). Incluye tapa de cristal resistente a los golpes con válvula. Borde de acero inoxidable 18/10.

Toute la pièce (corp et poignées) est fabriquée en acier inoxydable 18/10. Garantie max. en termes de résistance, de durabilité et d'hygiène. La forme bombée des corps confère une plus grande capacité. Marquage des contenances à l'intérieur (Litres). Fond thermodifusor sandwich (Inox 18/10 - Aluminium - Inoxydable). Distribution rapide et uniforme de la chaleur. Apté pour tous les types de feux (y compris l'induction et le four). Inclut un couvercle en verre avec soupape résistante aux chocs. Bord en acier inoxydable 18/10.

Garanzes Stück (Topf und Griffes) aus rostfreiem Stahl 18/10. Garantiert robust, langlebig und hygienisch. Konvex geformter Körper mit höherem Fassungsvermögen. Füllstandsanzeige (in Liter) auf der Innenseite. Wärmeleitender Sandwichboden (Edelstahl 18/10, Aluminium, Edelstahl). Gleichmäßige. Für alle Herdarten geeignet (inkl. Induktion und Ofen). Waschmaschinen tauglich. Deckel aus Glas mit stoßfestem Ventil. Rand aus nicht rostendem 18/10-Stahl.

The whole product (body and handles) is made in 18/10 st. steel. Max. guarantee in terms of resistance, durability and hygiene. Its rounded body provides greater capacity. Capacity markings on the inside (Litres). Heat-diffusing sandwiched base (18/10 Stainless Steel - Aluminium - Stainless Steel). Quick and even heat distribution. Suitable for all types of cookers (including induction hobs and ovens). It includes a glass cover with pressure valve resistant to bumps. 18/10 stainless steel rim.

Peça fabricada integralmente (corpo e asas) em aço inoxidável 18/10. Máx garantia de resistência, durabilidade e higiene. O design côncavo proporciona maior capacidade. Indicação de capacidades no interior (em litros). Fundo termodifusor tipo sanduícho (Inox 18/10 - Alumínio - Inoxidável). Distribuição rápida e uniforme do calor. Apta para todo o tipo de fogões (incluindo placas de indução e fornos). Tapa de vidro com válvula, resistente aos golpes. Rebordo em aço inoxidável 18/10.



Marcajes de capacidad
Capacity markings



Fondo curvo
Curved bottom

Cacerola con tapa
Faitout avec couvercle
Bratentopf mit Deckel
Casserole with lid
Caçarola com tampa



Ref	€	Ø (cm)	h (cm)	L	U.Venta
79016	38,60	16	8,5	1,20	1
79020	52,39	20	9,5	2,50	1
79024	71,38	24	11,5	4,40	1
79028	93,79	28	15,0	8,20	1

Olla con tapa
Marmite avec couvercle
Fleischtopf mit Deckel
Stock pot with Lid
Panela com tampa



Ref	€	Ø (cm)	h (cm)	L	U.Venta
79116	43,16	16	10,0	1,60	1
79120	59,24	20	12,0	3,50	1
79124	76,05	24	14,0	5,50	1
79128	100,64	28	17,0	9,50	1

Cazo Recto

Casserole
Stielkasserole, flach
Saucepan
Caçarola dreite



Ref	€	Ø (cm)	h (cm)	L	U.Venta
79214	27,09	14	9,0	1,20	1
79216	31,54	16	9,5	1,60	1
79218	35,79	18	10,5	2,50	1
79220	41,40	20	11,5	3,50	1

Cacerola vapor

Panier vapeur
Dampfkoch-Aufsatz
Steam casserole
Caçarola a vapor



Ref	€	Ø (cm)	h (cm)	L	U.Venta
79420	33,62	20	9,5	3,00	1
79424	44,82	24	12,0	4,50	1

Tartera con tapa

Plat rond avec couvercle
Pfanne mit Deckel
Round dish with lid
Tarteira com tampa



Ref	€	Ø (cm)	h (cm)	L	U.Venta
79624	59,55	24	7,5	2,60	1
79628	75,53	28	7,5	3,0	1

Pote

Pot
Milchtopf
Pot
Caneca



Ref	€	Ø (cm)	h (cm)	L	U.Venta
79724	27,08	14	11,0	1,50	1

Wok

Wok
Wok
Wok
Wok



Ref	€	Ø (cm)	h (cm)	L	U.Venta
79830	60,69	30	10,0	4,50	4

Tapa

Couvercle
Deckel
Lid
Tampa



Ref	€	Ø (cm)	U.Venta
79916	12,35	16	1
79920	16,50	20	1
79924	20,44	24	1
79928	25,83	28	1

Cacerola Ø16-20-24 cm
Cila Ø16-20 cm
Cazo Ø14-16 cm
Pote Ø14 cm

Bateria 8 piezas

Batterie 8 pcs
8-Tig-Batterie
Batterie 8 pcs
Bateria 8 pcs

Ref	€	U.Venta
79000	350,47	1





Toda la pieza (Cuerpo, asas y mangos) fabricada en Acero Inoxidable 18/10. Favorece una distribución rápida y homogénea del calor. Destaca por su diseño clásico, funcionalidad y sencillez. Acabado pulido brillante exterior y lijado mate interior. Apta para todo tipo de cocinas (incluido inducción y horno). Fondo Termodifusor sándwich (Inox 18/10 - Aluminio - Inox). Apta para el lavavajillas.

Toute la pièce (corps, poignées et manches) est fabriquée en acier inoxydable 18/10. Favorise une distribution rapide et homogène de la chaleur. Se distingue par son style classique, sa fonctionnalité et sa simplicité. Finition extérieure polie brillante et intérieur lissage mat. Compatible avec tout type de cuisinières (y compris induction et four). Fond thermo-diffusor sandwich (Inox 18/10 - Aluminium - Inox). Apta pour le lave-vaisselle.

Ganzes Stück (Topf, Griffe und Stiele) aus rostfreiem Stahl 18/10. Fördert gleichmäßige und schnelle Wärmeverteilung. Punktet mit klassischem Design, Funktionalität und einfacher Handhabung. Hochglanzpolierte Außen- und glänzend matte Innenseite. Für alle Herdarten geeignet (inkl. Induktion und Ofen). Wärmeleitlager Sandwichboden (Edelstahl 18/10 - Aluminium - Edelstahl). Waschmaschinen tauglich.

The whole product (body, handles and grips) is made in 18/10 stainless steel. It favours quick and homogeneous heat distribution. Stands out for its classic design, functionality and simplicity. Exterior glossy, polished finish and sanded matte interior. Suitable for all types of cooking surfaces (including induction and the oven). Sandwich heat diffuser (18/10 stainless steel - Aluminium - Stainless steel). Dishwasher safe.

Peça fabricada integralmente (corpo, asas e mangos) em aço inoxidável 18/10. Favorece a distribuição rápida e homogénea do calor. Design clássico, simples e funcional. Acabamento exterior polido brilhante, e mate lixado no interior. Apta para todo o tipo de fogões (incluindo placas de indução e forno). Fundo termodifusor tipo sanduiche (Inox 18/10 - Alumínio - Inox). Apta para máquinas de lavar louça.

Cacerola con tapa
Faitout avec couvercle
Bratentopf mit Deckel
Casserole with lid
Caçarola com tampa



Ref	€	Ø (cm)	h (cm)	L	U.Venta
40016	33,41	16	8,0	1,50	1
40018	36,42	18	8,5	2,00	1
40020	40,15	20	8,5	2,50	1
40022	44,20	22	9,0	3,00	1
40024	47,21	24	9,5	3,50	1
40026	53,54	26	9,5	4,50	1
40028	68,48	28	11,0	6,50	1
40032	86,32	32	12,5	9,50	1
40036	117,45	36	14,0	14,20	1
40040	136,22	40	15,5	19,50	1

Olla con tapa
Marmite avec couvercle
Fleischtopf mit Deckel
Stock pot with Lid
Panela com tampa



Ref	€	Ø (cm)	h (cm)	L	U.Venta
40116	37,56	16	13,0	2,50	1
40118	40,05	18	14,0	3,50	1
40120	43,78	20	14,5	4,50	1
40122	48,56	22	14,5	5,50	1
40124	54,57	24	15,0	6,50	1
40126	59,24	26	15,0	7,50	1
40128	75,01	28	17,0	10,00	1
40132	90,57	32	17,5	13,50	1
40136	128,44	36	21,5	22,00	1
40140	156,46	40	24,5	30,80	1

Olla super alta con tapa
Marmite S. Haute a/couvercle
Hoher Fleischtopf mit Deckel
Deep Stock pot with Lid
Panela super alta com tampa



Ref	€	Ø (cm)	h (cm)	L	U.Venta
40121	47,83	20	17,5	5,50	1
40125	62,35	24	20,0	9,00	1
40129	83,52	28	22,0	13,50	1
40133	123,57	32	28,0	22,50	1

Cazo Recto
Casserole
Stielkasserole, flach
Saucepan
Caçarola direite



Ref	€	Ø (cm)	h (cm)	L	U.Venta
40212	20,96	12	7,0	0,80	1
40214	21,79	14	7,5	1,00	1
40216	24,59	16	8,0	1,50	1
40218	26,87	18	8,5	2,00	1
40220	31,23	20	8,5	2,50	1

Cacerola vapor
Pamier vapeur
Dampfkoch-Aufsatz
Steam casserole
Caçarola a vapor



Ref	€	Ø (cm)	h (cm)	L	U.Venta
40420	29,78	20	8,5	2,50	1
40424	37,56	24	9,5	3,50	1
40428	41,19	28	11,0	6,50	1



Tartera con tapa
Plat rond avec couvercle
Pfanne mit Deckel
Round dish with lid
Tarteira com tampa

Ref	€	Ø (cm)	h (cm)	L	U.Venta
40620	40,05	20	6,5	2,00	1
40622	42,64	22	6,5	2,50	1
40624	47,00	24	7,0	3,00	1
40626	50,94	26	7,0	3,50	1
40628	63,50	28	8,0	4,50	1
40632	77,09	32	8,0	6,00	1
40636	102,19	36	8,5	7,50	1
40640	118,17	40	8,5	11,00	1

Cuecepastas sin tapa
Cuit-pâte sans couvercle
Nudelkoch-Einsatz ohne Deckel
Pasta cooker without lid
Coze-massas sem tampa



Ref	€	Ø (cm)	h (cm)	L	U.Venta
40426	56,65	24	17,5	9,50	1

Pote cilíndrico
Pot-cylindrique
Milchtopf
Cylindrical pot
Caneça cilíndrica



Ref	€	Ø (cm)	h (cm)	L	U.Venta
40712	24,69	12	12,0	1,00	1
40714	26,35	14	12,5	1,50	1
40716	29,05	16	13,0	2,50	1
40718	32,16	18	14,0	3,50	1

Escurridera
Passoire sur pied
Abtropfschüssel
Colander with stand
Escorredor



Ref	€	Ø (cm)	h (cm)	U.Venta
40324	41,71	24	11,0	1

Colador esférico
Passoire à queue
Seiher, mit Stiel
Strainer
Coador esférico



Ref	€	Ø (cm)	h (cm)	U.Venta
40318	26,66	18	8,5	1

Sartén VITROCOR
Poêle
Pfanne
Frying pan
Sertã



Ref	€	Ø (cm)	h (cm)	e (mm)	U.Venta
40619	28,01	18	4,5	0,7	1
40621	29,78	20	4,5	0,7	1
40623	30,92	22	5,0	0,7	1
40625	33,10	24	5,2	0,7	1
40627	34,03	26	6,0	0,7	1
40629	36,62	28	6,5	0,7	1

Tapa
Couvercle
Deckel
Lid
Tampa

Ref	€	Ø (cm)	U.Venta
40916	9,03	16	1
40918	9,13	18	1
40920	9,75	20	1
40922	10,27	22	1
40924	11,31	24	1
40926	12,14	26	1
40928	15,25	28	1
40932	19,09	32	1
40936	25,52	36	1
40940	29,05	40	1



Cacerola Ø16-20-24 cm
Olla Ø16-20 cm
Cazo Ø14-16 cm
Pote Ø14 cm

Bateria 8 piezas
Batterie 8 pcs.
8-Tig-Batterie
Battery 8 pcs.
Bateria 8 pcs.

Ref	€	U.Venta
40000	274,83	1



Inox 18/10
 Sandwich Vitro Electric Gas Induction Oven Dishwasher
 Toda la pieza (cuerpo, asas y mangos) fabricada en Acero Inoxidable 18/10.
 Favorece una distribución rápida y homogénea del calor.
 Extremadamente robustos.
 Acabado pulido brillante exterior y lijado mate interior.
 Apta para todo tipo de cocinas (Incluido inducción y horno).
 Triple fondo difusor que asegura un eficiente reparto del calor.

Toute la pièce (corps, poignées et manches) est fabriquée en acier inoxydable 18/10.
 Favorece une distribution rapide et homogène de la chaleur.
 Extrêmement robustes.
 Finition extérieure polie brillante et intérieur limage mat.
 Compatible avec tout type de cuisinières (y compris induction et four).
 Triple fond diffuseur qui garantit une répartition efficace de la chaleur.

Garzes Stück (Topf, Gritte und Stiele) aus rostfreiem Stahl 18/10.
 Fördert gleichmäßige und schnelle Wärmeverteilung.
 Sehr robust.
 Hochglanzpolierte Außen- und glänzend matte Innenseite.
 Für alle Herdarten geeignet (inkl. Induktion und Ofen).
 Dreifachboden gewährleistet leistungsstarke Wärmeföhrung.

The whole product (body, handles and grips) is made in 18/10 stainless steel.
 It favours quick and homogeneous heat distribution.
 Extremely robust.
 Exterior glossy, polished finish and sandec matte interior.
 Suitable for all types of cooking surfaces (including induction and the oven).
 Triple diffuser bottom assuring efficient distribution of heat.

Peça fabricada integralmente (corpo, asas e mangos) em aço inoxidável 18/10.
 Favorece a distribuição rápida e homogénea do calor.
 Extremamente robustas.
 Acabamento exterior polido brilhante, e mate lixado no interior.
 Apta para todo o tipo de fogões (incluindo placas de indução e forno).
 Fundo difusor triplo, para uma distribuição eficiente do calor.

Cacerola con tapa

Faitout avec couvercle
 Bratentopf mit Deckel
 Casserole with lid
 Caçarola com tampa



Ref	€	Ø (cm)	h (cm)	L	U.Venta
90016	37.14	16	8,0	1,50	1
90018	39.84	18	8,5	2,00	1
90020	43.68	20	8,5	2,50	1
90022	47.41	22	9,0	3,00	1
90024	51.25	24	9,5	3,50	1
90026	57.37	26	9,5	4,50	1
90028	70.45	28	11,0	6,50	1
90032	87.57	32	12,5	9,50	1

Olla con tapa

Marmite avec couvercle
 Fleischtopf mit Deckel
 Stock pot with Lid
 Panela com tampa



Ref	€	Ø (cm)	h (cm)	L	U.Venta
90116	40.77	16	13,0	2,50	1
90118	44.09	18	14,0	3,50	1
90120	46.69	20	14,5	4,50	1
90122	51.98	22	14,5	5,50	1
90124	57.58	24	15,0	6,50	1
90126	62.15	26	15,0	7,50	1
90128	77.19	28	17,0	10,00	1
90132	100.02	32	17,5	13,50	1

Olla super alta con tapa

Marmite S. Haute a/couvercle
 Hoher Fleischtopf mit Deckel
 Deep Stock pot with Lid
 Panela super alta com tampa



Ref	€	Ø (cm)	h (cm)	L	U.Venta
90125	66.09	24	20,0	9,00	1
90129	85.80	28	22,0	13,50	1

Cazo Recto

Casserole
 Stielkasserole, flach
 Saucepan
 Caçarola direite



Ref	€	Ø (cm)	h (cm)	L	U.Venta
90212	22.72	12	7,0	0,80	1
90214	23.97	14	7,5	1,00	1
90216	26.87	16	8,0	1,50	1
90218	29.05	18	8,5	2,00	1
90220	32.58	20	8,5	2,50	1

Cacerola vapor

Panier vapeur
Dampkoch-Aufsatz
Steam casserole
Çaçarola a vapor



Ref	€	Ø (cm)	h (cm)	L	U.Venta
90420	33,82	20	8,5	2,50	1
90424	41,60	24	9,5	3,50	1

Tartera con tapa

Plat rond a/couvercle
Pflanne mit Deckel
Round dish with lid
Tarteira com tampa



Ref	€	Ø (cm)	h (cm)	L	U.Venta
90620	43,68	20	6,5	2,00	1
90622	46,79	22	6,5	2,50	1
90624	50,01	24	7,0	3,00	1
90626	54,16	26	7,0	3,50	1
90628	64,53	28	8,0	4,50	1
90632	80,50	32	8,0	6,00	1

Escurridora

Passoire sur pied
Abtropfschüssel
Colander with stand
Escorredor



Ref	€	Ø (cm)	h (cm)	U.Venta
90324	40,36	24	11,0	1

Colador esférico

Passoire à queue
Seiher, mit Stiel
Strainer
Coador esférico



Ref	€	Ø (cm)	h (cm)	U.Venta
90318	26,66	18	8,5	1

Pote cilíndrico

Pot cylindrique
Milchtopf
Cylindrical pot
Caneca cilíndrica



Ref	€	Ø (cm)	h (cm)	L	U.Venta
90712	25,21	12	12,0	1,00	1
90714	26,66	14	12,5	1,50	1
90716	29,98	16	13,0	2,50	1
90718	32,47	18	14,0	3,50	1

Tapa

Couvercle
Deckel
Lid
Tampa



Ref	€	Ø (cm)	U.Venta
90916	9,96	16	1
90918	9,96	18	1
90920	10,06	20	1
90922	10,17	22	1
90924	11,21	24	1
90926	12,14	26	1
90928	15,87	28	1
90932	20,44	32	1

Capota Ø16-20-24 cm

Olla Ø18-20 cm

Cazo Ø14-16 cm

Foia Ø14 cm

Bateria 8 piezas

Batterie 8 pcs.
8-Tig-Batterie
Battery 8 pcs.
Bateria 8 pcs.

Ref	€	U.Venta
90000	297,04	1





Toda la pieza (cuerpo, asas y mangos) fabricada en Acero Inoxidable. La tapa, con cierre de precisión, preserva los aromas y retiene el calor. Ideal para cocinar de forma saludable y ahorrar energía. Acabado interior lijado satinado y exterior pulido brillante. Apta para todo tipo de cocinas (incluido inducción y horno). Apta para el lavavajillas.

Toute la pièce (corps, poignées et manches) est fabriquée en acier inoxydable. Le couvercle, avec fermeture de précision, préserve les arômes et retient la chaleur. Idéal pour cuisiner sainement et réaliser des économies d'énergie. Finition intérieure lissée satinée et extérieure polie brillante. Compatible avec tout type de cuisinières (y compris induction et four). Apte pour le lave-vaisselle.

Ganzes Stück (Topf, Griff) und Stiele) aus rostfreiem Stahl. Deckel mit Druckverschluss bewahrt Geschmack und Wärme. Ideal für gesundheitsbewusste und energiesparende Küche. Außenseit mit mattem Schillf und Innenseite hochglanzpoliert. Für alle Herdarten geeignet (inkl. Induktion und Ofen). Waschmaschinen tauglich.

The whole product (body, handles and grips) is made in stainless steel. The cover, with precision fit, retains the aromas and heat. Ideal for cooking healthy while saving energy. A sanded, satin interior finish and shiny, polished exterior. Suitable for all types of cooking surfaces (including induction and the oven). Dishwasher safe.

Peça fabricada integralmente (corpo, asas e mangos) em aço inoxidável. Tampo com fecho de precisão, para preservar melhor os aromas e conservar o calor. Ideal para cozinhar de forma saudável e poupar energia. Acabamento interior acetinado lixado, e brilhante polido no exterior. Apta para todo o tipo de fogões (incluindo placas de indução e forno). Apta para máquinas de lavar louça.



Cacerola con tapa

Faitout a/couvercle
Bratentopf mit Deckel
Casserole with lid
Caçarola com tampa

Ref	€	Ø (cm)	h (cm)	L	U.Venta
32016	27,39	16	8,0	1,50	1
32020	33,30	20	8,5	2,50	1
32024	41,29	24	9,5	3,50	1
32028	53,33	28	11,0	6,50	1



Olla con tapa

Marmite avec couvercle
Fleischtopf mit Deckel
Stock pot with Lid
Panela com tampa

Ref	€	Ø (cm)	h (cm)	L	U.Venta
32116	33,30	16	13,0	2,50	1
32120	36,94	20	13,5	4,50	1
32124	46,69	24	15,0	6,50	1
32128	60,69	28	17,0	10,00	1



Olla super alta con tapa

Marmite S. Haute a/couvercle
Hoher Fleischtopf mit Deckel
Deep Stock pot with Lid
Panela super alta com tampa

Ref	€	Ø (cm)	h (cm)	L	U.Venta
32125	57,27	24	20,0	9,00	1
32129	72,31	28	22,5	13,50	1



Cazo Recto

Casserole
Stielkasserole, flach
Saucepan
Caçarola direita

Ref	€	Ø (cm)	h (cm)	L	U.Venta
32214	16,08	14	7,5	1,00	1
32216	18,57	16	8,0	1,50	1
32218	20,54	18	8,5	2,00	1
32220	23,45	20	8,5	2,50	1

Cacerola vapor
Panier vapeur
Dampfkoch-Aufsatz
Steam casserole
Çaçarola a vapor



Ref	€	Ø (cm)	h (cm)	L	U.Venta
32420	21.17	20	8.5	2.50	1
32424	24.80	24	9.5	3.50	1

Tartera con tapa
Plat rond avec couvercle
Pfanne mit Deckel
Round dish with lid
Tarteira com tampa



Ref	€	Ø (cm)	h (cm)	L	U.Venta
32624	34.65	24	7.0	3.00	1
32628	48.56	28	8.0	4.50	1

Escurridera
Passoire sur pied
Abtropfschüssel
Colander with stand
Escorredor



Ref	€	Ø (cm)	h (cm)	U.Venta
32324	43.68	24	11.0	1

Tapa
Couvercle
Deckel
Lid
Tampa



Ref	€	Ø (cm)	U.Venta
32916	7.78	16	1
32920	9.44	20	1
32924	11.10	24	1
32928	13.80	28	1

Colador esférico
Passoire à queue
Seiher, mit Stiel
Strainer
Coador esférico



Ref	€	Ø (cm)	h (cm)	U.Venta
32318	31.54	18	8.5	1

Pote cilíndrico
Pot-cylindrique
Milchtopf
Cylindrical pot
Caneca cilíndrica



Ref	€	Ø (cm)	h (cm)	L	U.Venta
32714	20.85	14	12.5	1.50	1
32716	24.38	16	13.0	2.50	1

Cazo Ø14 cm
Ø16 cm
Ø18 cm
Ø20 cm

Lote 4 cazos
Ensemble 4 casseroles
Set 4 Tig, Stekkasserollen
Set 4 saucepans
Lote de 4 çaçarola



Ref	€	U.Venta
32003	78.64	1

Cacerola Ø16-20-24 cm
Olla Ø16-20 cm
Cazo Ø14-16 cm
Pote Ø14 cm

Bateria 8 piezas
Batterie 8 pcs
8-Tig-Batterie
Battery 8 pcs
Bateria 8 pcs



Ref	€	U.Venta
32000	227.73	1



Cuerpo fabricado en acero inoxidable 18/10.
Asas, mangos y pomo en baquelita termoaislante.
Destaca por su diseño clásico, funcionalidad y sencillez.
Acabado pulido brillante exterior y lijado mate interior.
Triple fondo difusor que asegura un eficiente reparto del calor.
Apta para todo tipo de cocinas (Incluido inducción). Apta para el lavavajillas.

Corps fabriqué en acier inoxydable 18/10.
 Poignées, manches et pommeau en bakélite thermo-isolante.
 Se distingue par son style classique, sa fonctionnalité et sa simplicité.
 Finition polie brillante extérieur et image mate intérieur.
 Triple fond diffuseur qui garantit une répartition efficace de la chaleur.
 Compatible avec tout type de cuisinières (y compris induction). Apte pour le lave-vaisselle.

Körper aus nicht rostendem 18/10-Stahl.
 Griffe, Stiele und Deckelgriff aus wärmeabweisendem Bakelit.
 Punktel mit klassischem Design, Funktionalität und einfacher Handhabung.
 Hochglanzpolierte Außen- und glänzende matte Innenseite.
 Dreifachboden garantiert leistungsstarke Wärmeführung.
 Für alle Herdarten geeignet (inkl. Induktion). Waschmaschinen tauglich.

Body made in 18/10 stainless steel.
 Handles, grips and knob in heat resistant bakelite.
 Stands out for its classic design, functionality and simplicity.
 Exterior glossy, polished finish and sanded matte interior.
 Triple diffuser bottom assuring efficient distribution of heat.
 Suitable for all types of cooking surfaces (including induction). Dishwasher safe.

Corpo fabricado em aço inoxidável 18/10.
 Asas, mangos e pomo em baquelite termo-isolante.
 Design clássico, prático e funcional.
 Acabamento exterior brilhante polido, e interior mate lixado.
 Fundo difusor triplo, para uma distribuição eficiente do calor.
 Apta para todo o tipo de fogões (incluido indução). Apta para máquinas de lavar louça.

Cacerola con tapa

Faitout avec couvercle.
 Bratentopf mit Deckel.
 Casserole with lid.
 Caçarola com tampa



Ref	€	Ø (cm)	h (cm)	L	U.Venta
88016	37,87	16	8,0	1,50	1
88018	40,46	18	8,5	2,00	1
88020	44,09	20	8,5	2,50	1
88022	48,24	22	9,0	3,00	1
88024	51,46	24	9,5	3,50	1
88026	57,69	26	9,5	4,50	1
88028	70,14	28	11,0	9,50	1
88032	89,23	32	12,5	9,50	1

Olla con tapa

Marmite avec couvercle.
 Fleischtopf mit Deckel.
 Stock pot with Lid.
 Panela com tampa



Ref	€	Ø (cm)	h (cm)	L	U.Venta
88116	41,71	16	13,0	2,50	1
88118	43,99	18	14,0	3,50	1
88120	47,00	20	14,5	4,50	1
88122	51,46	22	14,5	5,50	1
88124	57,48	24	15,0	6,50	1
88126	63,91	26	15,0	7,50	1
88128	77,81	28	17,0	10,00	1
88132	93,89	32	17,5	13,50	1

Olla super alta con tapa

Marmite S. Haute à/couvercle.
 Høher Fleischtopf mit Deckel.
 Deep Stock pot with Lid.
 Panela super alta com tampa



Ref	€	Ø (cm)	h (cm)	L	U.Venta
88121	51,36	20	17,5	5,50	1
88125	65,36	24	20,0	9,00	1
88129	92,03	28	22,0	13,50	1

Cazo Recto

Casserole.
 Stielkasserole, flach.
 Saucepan.
 Caçarola direita.



Ref	€	Ø (cm)	h (cm)	L	U.Venta
88212	22,51	12	7,0	0,80	1
88214	23,24	14	7,5	1,00	1
88216	25,52	16	8,0	1,50	1
88218	28,01	18	8,5	2,00	1
88220	32,16	20	8,5	2,50	1

Cacerola vapor

Panier vapeur
Dampfkoch-Aufsatz
Steam casserole
Caçarola a vapor



Ref	€	Ø (cm)	h (cm)	L	U.Venta
88420	35,17	20	9,0	2,50	1
88424	43,26	24	10,5	3,50	1

Tartera con tapa

Plat rond avec couvercle
Pfanne mit Deckel
Round dish with lid
Tarteira com tampa



Ref	€	Ø (cm)	h (cm)	L	U.Venta
88620	43,58	20	6,5	2,00	1
88622	47,00	22	6,5	2,50	1
88624	50,42	24	7,0	3,00	1
88626	54,26	26	7,0	3,50	1
88628	61,73	28	8,0	4,50	1
88632	78,85	32	8,0	5,00	1

Colador esférico

Passoire à queue
Seiher, mit Stiel
Strainer
Coador esférico



Ref	€	Ø (cm)	h (cm)	U.Venta
88318	28,84	18	8,5	1

Escurridera

Passoire sur pied
Abtropfschüssel
Colander with stand
Escurridor



Ref	€	Ø (cm)	h (cm)	U.Venta
88324	40,77	24	11,0	1

Pote cilíndrico

Pot-cylindrique
Milchtopf
Cylindrical pot
Caneca cilíndrica



Ref	€	Ø (cm)	h (cm)	L	U.Venta
88712	24,59	12	12,0	1,00	1
88714	26,66	14	12,5	1,50	1
88716	29,13	16	13,0	2,50	1
88718	32,16	18	14,0	3,50	1

Tapa

Couvercle
Deckel
Lid
Tampa



Ref	€	Ø (cm)	U.Venta
88916	8,92	16	1
88918	9,03	18	1
88920	9,55	20	1
88922	9,86	22	1
88924	10,48	24	1
88926	11,72	26	1
88928	14,53	28	1
88932	19,92	32	1

Cacerola Ø16-20-24 cm
Olla Ø16-20 cm
Cazo Ø14-16 cm
Pote Ø14 cm

Bateria 8 piezas

Batterie 8 pcs
8-Tig-Batterie
Battery 8 pcs
Bateria 8 pcs

Ref	€	U.Venta
88000	297,56	1





Pomo abatible
Folding knob



Cuerpo fabricado en acero inoxidable 18/10.
Asas, mangos y pomo en baquelita termoaislante.
Su pomo abatible consigue una reducción del espacio manteniendo una ergonomía perfecta.
Acabado pulido brillante exterior y lijado mate interior.
Triple fondo difusor que asegura un eficiente reparto del calor.
Apta para todo tipo de cocinas (Incluido inducción). Apta para el lavavajillas.

Corps fabriqué en acier inoxydable 18/10.
 Poignées, manches et pommeau en bakélite thermo-isolante.
 Son pommeau rabattable permet un gain d'espace en conservant une ergonomie parfaite.
 Finition extérieure polie brillante et intérieur limage mat.
 Triple fond diffuseur qui garantit une répartition efficace de la chaleur.
 Compatible avec tout type de cuisinières (y compris induction). Apte pour le lave-vaisselle.

Körper aus nicht rostendem 18/10-Stahl.
 Griffe, Stiele und Deckelgriff aus wärmeabweisendem Bakelit.
 Mit umklappbarem Deckelgriff - platzsparend und sehr ergonomisch.
 Hochglanzpolierte Außen- und matt geschliffene Innenseite.
 Dreifachboden garantiert leistungsstarke Wärmeführung.
 Für alle Herdarten geeignet (inkl. Induktion). Waschmaschinen tauglich.

Body made in 18/10-stainless steel.
 Handles, grips and knob in heat resistant bakelite.
 Its folding knob reduces storage space maintaining ergonomic perfection.
 Exterior glossy, polished finish and sanded matte interior.
 Triple diffuser bottom assuring efficient distribution of heat.
 Suitable for all types of cooking surfaces (including induction). Dishwasher safe.

Corpo fabricado em aço inoxidável 18/10.
 Asas, mangos e pomo em baquelite termo-islante.
 O pomo rebatível permite reduzir o espaço ocupado conservando a sua ergonomia.
 Acabamento exterior brilhante polido, e mate lixado no interior.
 Fundo difusor triplo, para uma distribuição eficiente do calor.
 Apta para todo o tipo de fogões (incluindo placas de indução).
 Apta para máquinas de lavar louça.

Cacerola con tapa
 Fajout avec couvercle
 Bratentopf mit Deckel
 Casserole with lid
 Caçarola com tampa



Ref	€	Ø (cm)	h (cm)	L	U.Venta
85016	38,28	16	8,0	1,50	1
85018	41,19	18	8,5	2,00	1
85020	45,03	20	8,5	2,50	1
85022	48,33	22	9,0	3,00	1
85024	52,08	24	9,5	3,50	1
85026	56,86	26	9,5	4,50	1
85028	65,47	28	11,0	6,50	1
85032	81,24	32	12,5	9,50	1

Olla con tapa
 Marmite a/couvercle
 Fleischtopf mit Deckel
 Stock pot with Lid
 Panela com tampa



Ref	€	Ø (cm)	h (cm)	L	U.Venta
85118	43,89	18	14,0	3,50	1
85120	48,24	20	14,5	4,50	1
85122	52,71	22	14,5	5,50	1
85124	57,69	24	15,0	6,50	1
85126	62,15	26	15,0	7,50	1
85128	73,35	28	17,0	10,00	1

Olla super alta con tapa
 Marmite S. Haute a/couvercle
 Hoher Fleischtopf mit Deckel
 Deep Stock pot with Lid
 Panela super alta com tampa



Ref	€	Ø (cm)	h (cm)	L	U.Venta
85125	65,67	24	20,0	9,00	1
85129	80,93	28	22,0	13,50	1

Cazo Recto
 Casserole
 Stielkasserole, flach
 Saucepan
 Caçarola direita



Ref	€	Ø (cm)	h (cm)	L	U.Venta
85212	22,20	12	7,0	0,80	1
85214	23,24	14	7,5	1,00	1
85216	25,52	16	8,0	1,50	1
85218	28,32	18	8,5	2,00	1
85220	31,96	20	8,5	2,50	1



Cacerola vapor
Panier vapeur
Dampkoch-Aufsatz
Steam casserole
Çaçarola a vapor

Ref	€	Ø (cm)	h (cm)	L	U.Venta
85420	33,72	20	9,0	2,50	1
85424	41,29	24	10,5	3,50	1



Sautex
Sautéuse
Sautéuse
Sautéuse
Frigideira

Ref	€	Ø (cm)	h (cm)	L	U.Venta
85624	34,45	24	7,0	3,50	1



Poto cilindric
Pot cylindrique
Milchtopf
Cylindrical pot
Caneca cilindrica

Ref	€	Ø (cm)	h (cm)	L	U.Venta
85712	25,11	12	12,0	1,00	1
85714	26,98	14	12,5	1,50	1
85716	28,53	16	13,0	2,50	1
85718	31,64	18	14,0	3,50	1



Tapa
Couvercle
Deckel
Lid
Tampa

Ref	€	Ø (cm)	U.Venta
85916	7,89	16	1
85918	8,40	18	1
85920	9,23	20	1
85922	9,44	22	1
85924	10,48	24	1
85926	10,89	26	1
85928	14,11	28	1



Sartén
Poêle
Platte
Frying pan
Sertàs

Ref	€	Ø (cm)	h (cm)	L	U.Venta
85625	32,58	24	7,0	3,50	1
85629	35,38	28	8,0	4,50	1



Øcazo Ø12 cm
Ø14 cm
Ø16 cm
Ø18 cm
Ø20 cm

Loto 5 cazos
Ensemble 5 casseroles
Set 5 Tig, Stiekasserollen
Set 5 saucepanis
Lote de 5 çaçarola

Ref	€	U.Venta
85003	131,24	1

Cacerola Ø16-20-24 cm
Cila Ø14-20 cm
Cazo Ø14-16 cm
Poto Ø14 cm

Bateria 8 piezas
Batterie 8 pcs
8-Tig Batterie
Battery 8 pcs
Bateria 8 pcs.

Ref	€	U.Venta
85000	300,98	1





Cuerpo fabricado en 3 capas: acero inoxidable 18/10, aluminio, acero inoxidable 18%. El aluminio interior garantiza una cocción uniforme de los alimentos, además de un ahorro importante en el uso de energía.

La capa exterior, es de acero inoxidable con componentes ferríticos, lo que la convierte totalmente compatible con las cocinas de inducción.

Las asas y los mangos están fabricados en acero inoxidable 18/10 y recubiertos con un protector térmico de silicona para un agarre perfecto y seguro.

La tapa de vidrio cuenta con un borde de silicona que le permite un cierre más eficiente y retener mayor calor, logrando así una mejor cocción.

Corps fabriqué avec 3 couches : acier inoxydable 18/10, aluminium, acier inoxydable 18%. L'aluminium intérieur garantit une cuisson uniforme des aliments, ainsi qu'une importante économie de l'utilisation de l'énergie nécessaire.

La couche extérieure est en acier inoxydable avec des composants ferritiques, ce qui lui permet d'être totalement compatible avec les cuisinières à induction.

Les poignées et les manches sont fabriqués en acier inoxydable 18/10 et recouverts d'une protection thermique en silicone pour faciliter une prise en main parfaite et sûre.

Le couvercle en verre possède un bord en silicone qui lui permet une fermeture plus efficace et de retenir davantage de chaleur, obtenant ainsi une meilleure cuisson.

Körper aus dreilagigem Material: rostfreier Stahl 18/10, Aluminium, rostfreier Stahl 18%. Zwischenlage aus Aluminium gewährleistet gleichmäßigen Kochvorgang und wirkt energiesparend.

Induktionsherdgeeignet, dank Außenschicht aus rostfreiem Stahl mit ferritischen Bestandteilen. Die Griffe und Saete aus rostfreiem Stahl 18/10 und mit wärmeabweisender Silikonummantelung geben sicheres und perfektes Halten.

Der Glasdeckel mit Silikonumrandung sorgt für festen Verschluss und Wärmerückhalt und damit für einen optimierten Kochvorgang.

Body manufactured in a 3-layered: 18/10 stainless steel, aluminium, 18% stainless steel. The interior aluminium guarantees uniform cooking of the food. Besides an important savings in the use of the necessary energy.

Exterior layer of stainless steel with ferrite materials, making it completely compatible with induction cookers.

The handles and grips are made in 18/10 stainless steel and covered in a silicone heat protection for easy and safe gripping.

The glass cover has a silicone border permitting a more efficient covering and heat retention, resulting in better cooking.

Corpo fabricado em 3 camadas: aço inoxidável 18/10, alumínio, aço inoxidável 18%. O interior de alumínio garante uma cocção uniforme dos alimentos, e uma grande poupança de energia.

Capa exterior de aço inoxidável com componentes ferríticos, totalmente compatível com as placas de Indução.

Asas e mangos fabricados em aço inoxidável 18/10, revestidos com um protetor térmico de silicone para uma sujeição perfeita e segura.

Tampa de vidro com rebordo de silicone, para um fecho mais eficiente e uma maior retenção do calor, proporcionando uma cocção melhor dos alimentos.



Cacerola con tapa
Faitout avec couvercle
Bralentopf mit Deckel
Casserole with lid
Caçarola com tampa



Ref	€	Ø (cm)	h (cm)	L	U.Venta
53016	64,53	16	9,0	1,80	1
53018	75,01	18	10,0	2,50	1
53020	83,62	20	11,0	3,50	1
53024	99,29	24	13,0	5,50	1

Cazo recto
Casserole
Sielkasserole, flach
Saucepan
Caçarola direita



Ref	€	Ø (cm)	h (cm)	L	U.Venta
53214	43,06	14	7,0	0,80	1
53216	47,00	15	8,0	1,30	1
53218	51,98	18	9,0	2,00	1
53220	58,00	20	10,0	3,00	1



Tapa
Couvercle
Deckel
Lid
Tampa

Ref	€	Ø (cm)	U.Venta
S3916	16,81	16	1
S3918	17,33	18	1
S3920	18,09	20	1
S3924	18,78	24	1



Sautex
Sautouse
Sautéuse
Sautouse
Frigideira

Ref	€	Ø (cm)	h (cm)	L	U.Venta
S3625	64,84	24	7,0	2,60	1



Sartén
Poêle
Pfanne
Frying pan
Sertã

Ref	€	Ø (cm)	h (cm)	L	U.Venta
S3720	48,76	20	4,5	1,00	1
S3724	54,37	24	5,0	1,50	1
S3728	66,61	28	5,5	2,50	1



Wok
Wok
Wok
Wok
Wok

Ref	€	Ø (cm)	h (cm)	L	U.Venta
S3828	72,42	28	8,0	3	1



Sartén antiadherente
Poêle antiadhérent
Pfanne, Antihalt
Non-stick frying pan
Sertã anti-aderente



Ref	€	Ø (cm)	h (cm)	L	U.Venta
S3721	57,37	20	4,5	1,00	1
S3725	68,68	24	5,0	1,50	1
S3729	86,74	28	5,5	2,50	1

Recubrimiento antiadherente TRICAPA Eclipse Plus de dureza extrema, libre de PFOA.
Aptas para todo tipo de fuegos.

Dotée d'un revêtement antiadhésif Tri-couche Eclipse Plus d'une dureté extrême, sans PFOA.
Compatible avec tout type de feux.

Pinne mit sehr harter Antihaltbeschichtung TRICAPA Eclipse Plus ohne PFOA.
Für alle Herdarten geeignet.

This pan with TRICAPA Eclipse Plus non-stick coating offers extreme hardness and is PFOA free.
Suitable for all types of cookers.

Revestimento antiadherente TRICAPA Eclipse Plus de dureza extrema, sem PFOA.
Aptas para todo tipo de fogos.



Wok antiadherente
Wok, Antiadhérent
Wok, Antihalt
Wok, non-stick
Wok anti-aderente



Ref	€	Ø (cm)	h (cm)	L	U.Venta
S3829	82,27	28	8,0	3	1

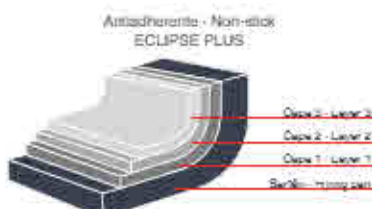



Cuerpo fabricado en Acero Inoxidable 18/10.
Asas, mangos y pomo en baquelita termoisolante.
Acabado pulido brillante.
Fondo Termodifusor (Inox 18/10 - Aluminio - Inox).
Apta para todo tipo de cocinas (incluido inducción).
Apta para el lavavajillas.



Corps fabriqué en acier inoxydable 18/10.
 Poignées, manches et pommeau en bakélite thermo-isolante.
 Finition polie brillante.
 Fond thermo-diffusor (Inox 18/10 - Aluminium - Inox).
 Compatible avec tout type de cuisinières (y compris induction).
 Apté pour le lave-vaisselle.

Körper aus nicht rostendem 18/10-Stahl.
 Griffe, Stiele und Deckelgriff aus wärmeabweisendem Bakelit.
 Hochglanzpoliert.
 Wärmekleitender Boden (Edelsahl 18/10 - Aluminium - Edelstahl).
 Für alle Herdarten geeignet (inkl. Induktion).
 Waschmaschinen-tauglich.

Body made in 18/10 stainless steel.
 Handles, grips and knob in heat resistant bakelite.
 Glossy polished finish.
 Heat diffuser bottom (18/10 stainless steel - Aluminium - Stainless Steel).
 Suitable for all types of cooking surfaces (including induction).
 Dishwasher safe.

Corpo fabricado em aço inoxidável 18/10.
 Asas, mangos e pomo em baquelite termo-isolante.
 Acabamento brilhante polido.
 Fundo termodifusor (Inox 18/10 - Alumínio - Inox).
 Apta para todo o tipo de fogões (incluindo placas de indução).
 Apta para máquinas de lavar louça.



Cacerola con tapa
 Faitout a/couvercle
 Bratentopf mit Deckel
 Casserole with lid
 Caçarola com tampa

Ref	€	Ø (cm)	h (cm)	L	U.Venta
14318	24,17	18	9,0	2,00	1
14320	27,91	20	10,0	3,00	1
14322	32,89	22	11,0	4,00	1
14324	37,97	24	12,0	5,00	1



Olla con tapa
 Marmite avec couvercle
 Fleischtopf mit Deckel
 Stock pot with Lid
 Panela com tampa

Ref	€	Ø (cm)	h (cm)	L	U.Venta
14420	29,88	20	12,0	3,80	1
14422	35,07	22	13,0	5,00	1
14424	42,02	24	15,0	7,00	1



Cazo Recto
 Casserole
 Stielkasserole, flach
 Saucepan
 Caçarola direita

Ref	€	Ø (cm)	h (cm)	L	U.Venta
14212	8,61	12	5,5	0,60	1
14214	10,69	14	6,5	1,50	1
14216	13,38	16	7,5	1,50	1
14218	16,08	18	9,0	2,00	1
14220	18,99	20	10,0	3,00	1

Cazo Ø12 cm
 Ø14 cm
 Ø16 cm
 Ø18 cm
 Ø20 cm



Lote 5 cazos
 Ensemble 5 casseroles
 Set 5 Tlg. Stielkasserolien
 Set 5 saucepans
 Lote de 5 caçarola

Ref	€	U.Venta
14205	67,75	1



Fabricada en Aluminio fundido y construida en una sola pieza.
Máxima robustez y gran resistencia a la deformación.
Ideal para guisos, cocidos, sopas y salsas.
Revestimiento antiadherente interior y exterior, libre de PFOA.
Apta para todo tipo de cocinas (Incluido inducción).
Incluye una tapa de vidrio templado con válvula resistente a los golpes.

Fabricée en fonte d'aluminium et construite en une seule pièce.
Robustesse maximale et grande résistance à la déformation.
Idéal pour les ragouts, pot-au-feu, soupes et sauces.
Revêtement antiadhésif intérieur et extérieur sans PFOA.
Compatible avec tout type de cuisinières (y compris induction).
Inclut un couvercle en verre trempé avec soupape résistante aux chocs.

In einem Stück aus Aluminium gegossen.
Höchst widerstandsfähig und formbeständig.
Ideal für Schmorgerichte, Eintöpfe, Suppen und Soßen.
Antihaftbeschichtung innen und außen, ohne PFOA.
Für alle Herdarten geeignet (inkl. Induktion).
Deckel aus gehärtetem Glas mit stoßfestem Ventil.

Made in Cast Aluminium and in a single piece.
Maximum robustness and great resistance to deformation.
Ideal product for stews, soups and sauces.
Interior non-stick coating and exterior, PFOA free.
Suitable for all types of cooking surfaces (including induction).
It includes a tempered glass cover with pressure valve resistant to bumps.

Fabricada em alumínio fundido e como uma única peça.
Máxima robustez e grande resistência à deformação.
Ideal para estofados, cozidos, sopas e molhos.
Revestimento antiaderente interior e exterior, isento de PFOA.
Apta para todo o tipo de fogões (incl. placas de indução).
Tampa de vidro temperado com válvula, resistente aos golpes.

Cacerola con tapa cristal
 Faitout avec couvercle verre
 Bratentopf mit Glasdeckel
 Round casserole with glass lid
 Caçarola com tampa de vidro



Ref	€	Ø (cm)	h (cm)	L	U.Venta
25816	27,18	16	8,5	1,50	1
25820	29,47	20	8,5	2,50	1
25824	36,73	24	10,5	4,50	1
25828	45,03	28	12,5	7,00	1
25831	53,43	30	13,5	8,70	1

Cacerola baja con tapa cristal
 Faitout bas avec couvercle verre
 Bratentopf mit Glasdeckel
 Round low casserole with glass lid
 Caçarola baixa com tampa de vidro



Ref	€	Ø (cm)	h (cm)	L	U.Venta
25823	36,94	24	7,5	2,60	1
25827	45,24	28	7,5	3,60	1
25832	58,62	32	7,5	5,20	1
25835	67,75	36	8,5	7,50	1

Cacerola cuadrada con tapa cristal
 Faitout carré avec couvercle verre
 Bratentopf mit Glasdeckel
 Square casserole with glass lid
 Caçarola quadrada com tampa de vidro



Ref	€	cm	h (cm)	L	U.Venta
25825	42,33	24x24	10,0	4,70	1
25829	53,12	28x28	12,0	7,50	1

Cacerola baja cuadrada c/tapa cristal
 Faitout basse carré a/couvercle verre
 Bratentopf mit Glasdeckel
 Square low square casserole with glass lid
 Caçarola baixa quadrada c/ tampa de vidro



Ref	€	cm	h (cm)	L	U.Venta
25830	51,56	28x28	9,0	4,20	1



Cacerola robusta y duradera gracias a su cuerpo fabricado en aluminio fundido. Fabricada en una sola pieza.
Antiadherente TRICapa Quantumium. Recubrimiento de máxima calidad reforzada con partículas a base de titanio.
Libre de materiales pesados y tóxicos. ECO y libre PFOA.
Compatible con todas las fuentes de calor, incluida la inducción.
Fácil limpieza interior y exterior.

Casserole robuste et durable grâce à son corps fabriqué en fonte d'aluminium. Fabriquée en une seule pièce.
 Antiadhésif Tri-couche Quantumium. Revêtement de la plus grande qualité renforcé avec des particules à base de titane.
 Sans matériaux lourds et toxiques. ECO et sans PFOA.
 Compatible avec toutes les sources de chaleur, y compris l'induction.
 Nettoyage intérieur et extérieur facile.

Stabiler und haltbarer Kochtopf aus Aluminiumguss.
 Aus einem Stück.
 Dreilagige Antihaftbeschichtung Quantumium (Äußere): hochwertige Beschichtung mit Titanbelmischung. Frei von Schwermetallen und Giftstoffen. ECO-zertifiziert und PFOA-frei.
 Für alle Herdarten geeignet, einschließlich Induktion. Innen und außen einfach zu reinigen.

Robust and durable casserole thanks to its cast aluminium body.
 One piece construction.
 Non-stick TRI-layer Quantumium top quality coating reinforced with titanium-based particles.
 Free of heavy and toxic materials. ECO and PFOA free.
 Compatible with all heat sources, including induction.
 Easy to clean interior and exterior.

Caçarola robusta e durável, graças ao seu corpo fabricado em alumínio fundido. Fabricada numa só peça.
 Antiadherente TRICapa Quantumium. Revestimento de máxima qualidade, reforçado com partículas à base de titânio.
 Não contém materiais pesados e tóxicos. ECO e livre de PFOA.
 Compatível com todas as fontes de calor, incluindo placas de indução.
 Fácil limpeza interior e exterior.



Tapa de vidrio templado reforzada con un aro protector de silicona anti impactos y una válvula de salida de vapor.

Couvercle en verre trempé renforcé avec un pourtour de protection en silicone anti-impacts et une valve de sortie de vapeur.
 Deckel aus gehärtetem Glas, stabilisiert, verstärkt mit Schutzring aus Silikon, mit Dampfablassventil.
 Tempered glass lid reinforced with an anti-shock silicone protective ring and a steam outlet valve.
 Tampa de vidro temperado, reforçada com um aro protetor de silicone anti-impactos e com válvula de saída de vapor.



Asas EXTRAÍBLES fabricadas en silicona de máxima calidad, termo aislantes, altamente resistentes y ergonómicas, permiten un agarre seguro. Mango con acabado SOFT TOUCH, termo aislante, altamente resistente y ergonómico, permite un agarre seguro.

Poignées AMOVIBLES fabriquées en silicone de la plus grande qualité, thermo-isolantes, hautement résistantes et ergonomiques, qui permettent de tenir l'ustensile en toute sécurité. Manche avec finition SOFT TOUCH, thermo isolant, hautement résistant et ergonomique, permet une prise en main sûre.
 Hochwertige, ergonomische ABNEHMBARE Silikongriffe mit hoher Temperaturbestigkeit gewährleisten ein sicheres Halten des Geschirrs.
 Soft-Touch-Stiel, wärmeisoliert, hoch widerstandsfähig und ergonomisch, sorgt für sicheren Halt.
 Heat insulating, highly resistant, ergonomic REMOVABLE handles made of high quality silicone which provide a secure grip on pots and pans. Handle with SOFT TOUCH finish, heat insulating, highly resistant and ergonomic, allows a secure grip.

Asas REMOVÍVEIS fabricadas em silicone de grande qualidade, termo-isolantes, altamente resistentes e ergonómicas, que permitem agarrar a peça com segurança. Mango com acabamento SOFT TOUCH, termo-isolante, altamente resistente e ergonómico, que permite uma sujeição segura.



Fondo difusor FULL INDUCTION; asegura un rendimiento óptimo en todo tipo de cocinas, con un reparto de calor inmejorable logrando la máxima eficiencia y ahorro de energía.

Fond diffuseur FULL INDUCTION, garantit un rendement optimal sur tout type de cuisinières, avec une répartition de la chaleur unique, obtenant ainsi une efficacité et une économie d'énergie maximales.
 Wärmeverteiler Boden FULL INDUCTION für optimale Leistung bei allen Herdtypen, mit hervorragender Wärmeverteilung, maximaler Effizienz und Energieeinsparung.

The FULL INDUCTION diffuser base ensures optimum performance with all kinds of cookers. Its unbeatable heat distribution achieves the best efficiency and energy savings.

Fundo difusor FULL INDUCTION, que assegura um ótimo rendimento em todo o tipo de placas de coção e fogões, com excelente distribuição de calor, para máxima eficiência e economia energética.

Incluye asas de silicona
Includes silicone handles



Cacerola con tapa

Faitout avec couvercle
Bratentopf mit Deckel
Casserole with lid
Caçarola com tampa

Ref	€	Ø (cm)	h (cm)	L	U.Venta
27520	43,99	20	9,5	2,60	1
27524	53,12	24	11,0	4,40	1
27528	64,74	28	12,0	6,60	1



Cazo Recto

Casserole
Stielkasserolle, flach
Saucepan
Caçarola direita



Ref	€	Ø (cm)	h (cm)	L	U.Venta
27516	25,42	16	8,0	1,35	1

Incluye asas de silicona
Includes silicone handles



Tartera con tapa

Plat rond avec couvercle
Pfanne mit Deckel
Round dish with lid
Tarteira com tampa

Ref	€	Ø (cm)	h (cm)	L	U.Venta
27728	60,59	28	7,5	4,10	1
27732	72,63	32	8,0	5,70	1
27736	85,59	36	8,0	7,30	1



Sartón

Poêle
Pfanne
Frying-pan
Serdã



Ref	€	Ø (cm)	h (cm)	U.Venta
27820	26,66	20	5,0	6
27824	32,89	24	5,5	4
27828	39,94	28	6,0	6



Grill

Grill
Grill Induktionfähig
Grill
Grelhador



Ref	€	cm	h (cm)	U.Venta
27827	46,38	28x28	4,0	1



Compartimentos individuales
Individual compartments



Sartón 4 cavidades

Poêle 4 cavités
Pfanne, 4-fache Einteilung
Frying pan 4 cavities
Serdã 4 cavidades



Ref	€	cm	h (cm)	U.Venta
27832	40,05	32x26	3,5	1



Aro protector de silicona
Silicone protective ring



Tapa de cristal

Couvercle en verre
Glasdeckel
Glass lid
Tampa de vidro

Ref	€	Ø (cm)	U.Venta
27420	9,03	20	1
27424	10,58	24	1
27428	12,14	28	1
27432	13,80	32	1
27436	15,36	36	1

Si

Silicone

Asas para batería TITANIUM

Poignées
Griffchutz, Silikon
Handles
Asas



Ref	€	Ø (cm)	U.Venta
R27520A	3,74	20	1
R27528A	3,84	24-28	1
R27732A	4,77	32-36	1



Gracias al tratamiento electroilítico empleado en su proceso de fabricación, el aluminio se sella completamente y se endurece para que no pase a los alimentos. Antiadherente QuanTanium® reforzado con partículas de titanio; libre de tóxicos, materiales pesados y sin PFOA.
 Gran durabilidad y ultra resistente: Superficie robusta altamente resistente a roces, deformación y corrosión.
 Difunde el calor de forma uniforme evitando el sobrecalentamiento y obteniendo excelentes resultados de cocción.
 Mangos / Asas de acero inoxidable con remaches de aluminio que impiden la transferencia de calor.
 Tapas de vidrio templado reforzadas en el borde con acero inoxidable.
 Apto para todo tipo de fuegos.

Grâce au traitement électrolytique utilisé lors de son processus de fabrication, l'aluminium est totalement scellé et durci pour ne pas pouvoir atteindre les aliments. Revêtement antiadhésif QuanTanium® renforcé avec des particules de titane : sans produits toxiques, sans métaux lourds et sans PFOA.
 Grande durabilité et ultra résistante : Surface robuste hautement résistante aux rayures, à la déformation et à la corrosion.
 Diffuse la chaleur de façon uniforme, évitant ainsi la surchauffe et obtenant d'excellents résultats de cuisson.
 Anses et poignées en acier inoxydable avec des rivets en aluminium qui empêchent le transfert de chaleur.
 Couvertres en verre trempé renforcés avec le bord en acier inoxydable.
 Apte pour tous types de feux.

Dank der elektrolytischen Behandlung während des Herstellungsprozesses wird das Aluminium komplett versiegelt und härter aus, um die Lebensmittel nicht zu kontaminieren.
 Antihaftbeschichtung QuanTanium®, verstärkt mit Titanpartikeln, frei von Giftstoffen, Schwermetallen und PFOA-frei.
 Lange Haltbarkeit und äußerst beständig: robuste, verformungs-, kratz- und korrosionsbeständige Oberfläche.
 Gleichmäßige Wärmeverteilung bei Vermeidung von Überhitzungen für hervorragende Kochergebnisse.
 Griffe / Stiele aus Edelstahl mit Aluminiumnieten zur Vermeidung von Wärmeübertragungen.
 Gehärteter Glasdeckel mit edelstahlverstärktem Rand.
 Für alle Herde geeignet.

Because of the electrolytic treatment used in the manufacturing process, the aluminum is completely sealed and hardened so no metal is passed on to the food. Non-stick QuanTanium®, reinforced with titanium particles, is free of toxins, heavy metals and PFOA.
 Extremely durable and ultra-high strength: It has a robust surface that is highly resistant to abrasion, warping and corrosion.
 It distributes heat evenly to avoid overheating and provide excellent cooking results.
 Stainless steel handles with aluminium rivets that avoid heat transfer.
 The lid is tempered glass with stainless steel reinforcement around the edge.
 Suitable for all kinds of cookers.

O tratamento eletrolítico utilizado no processo de fabrico sela e endurece o alumínio, evitando a contaminação dos alimentos com partículas de metal. Antiaderente QuanTanium® reforçado com partículas de titânio, sem produtos tóxicos, materiais pesados ou PFOA.
 Grande durabilidade e ultra resistente: superfície robusta, altamente resistente à fricção, deformação e corrosão.
 Difunde o calor de forma uniforme, evitando o sobreaquecimento, com excelentes resultados de cocção.
 Manga/Asas em aço inoxidável com rebitas de alumínio que impedem a transferência do calor.
 Tampas de vidro temperado, com rebordo reforçado em aço inoxidável.
 Apta para todo o tipo de fogões e placas de cocção.



Capa de óxido natural de protección muy gruesa
 Couche d'oxydation naturelle de protection très épaisse.
 Natürliches, sehr dicke Oxidationsschutzschicht.
 Thick natural oxide protective layer.
 Capa de óxido natural com proteção grossa.



Muy resistentes a arañazos, deformaciones y corrosión
 Très résistante aux rayures, à la déformation et à la corrosion.
 Äußerst kratzfest, verformungsstabil und korrosionsbeständig.
 Very resistant to scratches, deformation and corrosion.
 Muito resistentes a riscos, deformação e corrosão.

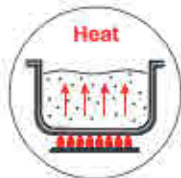

Distribuye uniformemente el calor, sin áreas de sobrecalentamientos
 Distribue uniformément la chaleur, sans zones de surchauffe.
 Gleichmäßige Wärmeübertragung ohne Überhitzungen.
 Hot spot free, uniform heat distribution.
 Distribui uniformemente o calor, sem áreas de sobreaquecimento.



Cacerola con tapa
 Faitout avec couvercle
 Bräntopf mit Deckel
 Casserole with lid
 Caçarola com tampa

Ref	€	Ø (cm)	h (cm)	L	e (mm)	U.Venta
48016	36,73	16	8,0	1,50	4,5	1
48020	44,51	20	9,0	2,60	4,5	1
48024	54,68	24	10,0	4,20	4,5	1
48028	64,22	28	11,0	6,30	4,5	1



Olla con tapa
 Marmite avec couvercle
 Fleichtopf mit Deckel
 Stock pot with lid
 Panela com tampa

Ref	€	Ø (cm)	h (cm)	L	e (mm)	U.Venta
48116	42,33	16	13,0	2,50	4,5	1
48120	50,01	20	14,0	4,20	4,5	1
48124	62,87	24	15,0	6,50	4,5	1
48128	75,01	28	17,0	10,00	4,5	1



Cazo recto
 Casserole
 Stielkasserolle, flach
 Saucepan
 Caçarola dreite

Ref	€	Ø (cm)	h (cm)	L	e (mm)	U.Venta
48214	25,52	14	7,5	1,00	4,5	1
48216	28,43	16	8,0	1,50	4,5	1
48218	31,96	18	9,0	2,10	4,5	1
48220	36,11	20	10,0	2,90	4,5	1



Tartera con tapa
 Plat rond avec couvercle
 Platte mit Deckel
 Round dish with lid
 Tarteira com tampa

Ref	€	Ø (cm)	h (cm)	L	e (mm)	U.Venta
48624	49,39	24	7,0	2,90	4,5	1
48628	59,03	28	8,0	4,50	4,5	1



Sartén
 Poêle
 Pfanne
 Frying pan
 Sertã

Ref	€	Ø (cm)	h (cm)	L	e (mm)	U.Venta
48720	27,81	20	4,0	0,90	4,5	6
48724	34,76	24	4,5	1,50	4,5	6
48728	41,50	28	5,0	2,70	4,5	6

Aro protector de acero inoxidable
 Stainless steel protective ring

Vidrio templado
 Tempered glass



Tapa
 Couvercle
 Deckel
 Lid
 Tampa

Ref	€	Ø (cm)	U.Venta
48916	10,38	16	1
48920	11,62	20	1
48924	12,87	24	1
48928	14,32	28	1



Construidas en aluminio fundido de una sola pieza.
 Garantiza una resistencia máxima y una distribución homogénea del calor.
 Revestimiento antiadherente de alta calidad y ecológico, libre de PFOA.
 Reforzada con un acabado en piedra.
 Pomo y asa SOFT TOUCH.
 Tapa de cristal con cierre de silicona.
 Apta para todo tipo de cocinas, incluida la inducción.

Fabricades en l'ence d'aluminium d'une seule pièce
 Garantit une résistance maximale et une distribution homogène de la chaleur
 Revêtement antiadhésif de grande qualité et écologique, sans PFOA.
 Renforcée avec une finition en pierre
 Pommeau et poignée SOFT TOUCH
 Couverture en verre avec fermeture en silicone
 Compatible avec tout type de cuisinières, y compris à induction

In einem Stück aus Aluminium gegossen
 Gewährleistet höchste Widerstandsfähigkeit und gleichmäßige Wärmeverteilung
 Umweltfreundliche und qualitative Antiflimbeschichtung ohne PFOA
 Mit Steinbeschichtung gehärtet
 SOFT TOUCH Griff, Glasdeckel mit Silikonichtung
 Für alle Herdarten geeignet, inkl. Induktion

Made in a single, cast aluminum body
 This guarantees maximum resistance and a homogeneous distribution of heat
 Its high quality and eco-friendly non-stick coating is PFOA-free
 Reinforced with a stone finish
 SOFT TOUCH knob and handle
 Glass cover with silicone seal
 Apt for all types of cooking surfaces (including induction)

Fabricadas em alumínio fundido de uma só peça
 Oferece máxima resistência e uma distribuição homogênea do calor
 Revestimento antiaderente de alta qualidade e ecológico, isento de PFOA
 Reforçadas com acabamento em pedra
 Pomo e asa SOFT TOUCH
 Tampa de vidro com fecho de silicone
 Aptas para todo o tipo de placas, incluindo as de indução

Pomos y asas presentan un aspecto de madera
Acabado SOFT TOUCH
 Knobs and handles have a wooden look
 SOFT TOUCH finish

La tapa de cristal se ajusta perfectamente con el cierre de silicona
 The glass lid fits perfectly with silicone seal



Recubrimiento antiadherente acabado en piedra
 Non-stick coating finished in stone



Cacerola con tapa cristal

Faitout avec couvercle verre
 Bratentopf mit Glasdeckel
 Casserole with glass lid
 Caçarola com tampa de vidro

Ref	€	Ø (cm)	h (cm)	L	U.Venta
27320	44,41	20	10,5	2,50	1
27324	51,56	24	12,0	4,00	1
27328	60,69	28	12,5	6,00	1



Cacerola baja con tapa cristal

Faitout bas avec couvercle verre
 Bratentopf mit Glasdeckel
 Low casserole with glass lid
 Caçarola baixa com tampa de vidro

Ref	€	Ø (cm)	h (cm)	L	U.Venta
27327	57,58	28	8,5	4,00	1



Cazo recto

Casserole
 Stielkasserole, flach
 Saucepan
 Caçarola direita

Ref	€	Ø (cm)	h (cm)	L	U.Venta
27416	28,32	16	7,5	1,20	1
27418	30,19	18	8,8	1,80	1

Aro protector de silicona

Silicone protective ring



Tapa cristal

Couvercle verre
 Glasdeckel
 Glass lid
 Tampa de vidro

Ref	€	Ø (cm)	U.Venta
27920	7,68	20	1
27924	8,82	24	1
27928	10,79	28	1



Sartén

Poêle
 Pfanne
 Frying pan
 Sertã

Ref	€	Ø (cm)	h (cm)	U.Venta
27620	29,57	20	4,5	6
27624	33,72	24	5,2	6
27626	37,14	26	5,5	6
27628	40,15	28	6,0	6



Grill

Grill
 Grill Induktionfähig
 Grill
 Grelhador

Ref	€	cm	h (cm)	U.Venta
27625	37,14	24x24	4,8	1
27629	43,06	28x28	5,2	1

►COCOTTES



Fabricadas en aluminio fundido.
Garantizan la absorción y distribución uniforme del calor, sin puntos de sobrecalentamiento.
La distribución del calor uniforme por toda la pieza hace que los alimentos no pierdan su jugo durante la cocción, conservando así todos sus nutrientes y vitaminas.
Las puntas situadas bajo la tapa, hacen que las gotas fruto de la condensación, vuelvan a caer sobre los alimentos formando un flujo circular y permanente reduciendo la pérdida de sabores y jugos de los alimentos.
Es la pieza perfecta para: arroces, carnes, pescados, legumbres, verduras, guisos, cremas, salsas, sopas, etc.
Revestimiento antiadherente ILAG:ULTIMATE.
Diseño atractivo y funcional.

Fabriquée en fonte d'aluminium.
 Garantit l'absorption et la distribution uniforme de la chaleur, sans points de surchauffe.
 La distribution de la chaleur uniforme sur toute la pièce permet aux aliments de ne pas perdre leur jus pendant la cuisson, conservant ainsi tous leurs nutriments et vitamines.
 Les pointes situées sous le couvercle permettent aux gouttes issues de la condensation de retomber sur les aliments, formant ainsi un flux permanent de circulation qui réduit la perte des saveurs et des jus des aliments.
 C'est la pièce parfaite pour : riz, viandes, poissons, légumes, ragoûts, crèmes, sauces, soupes, etc.
 Revêtement antiadhésif ILAG: ULTIMATE.
 Style attractif et grande fonctionnalité.

Aus gegossenen Aluminium.
 Garantiert gleichmäßige Wärmeaufnahme und -verteilung ohne Überhitzungspunkte. Gleichmäßige Wärmeverteilung im gesamten Kessel erhalten die Lebensmittel beim Kochen saftig und somit auch alle ihre Nährstoffe und Vitamine.
 Die Spitzen unter dem Deckel bewirken, dass die Kondensations Tropfen wieder auf das Kochgut tropfen und so einen permanent zirkulierenden Fluss darstellen, der den Verlust von Geschmack und Flüssigkeit der Lebensmittel verhindert.
 Ideal für Reis, Fleisch, Fisch, Hülsenfrüchte, Gemüse, Schnitzgerichte, Cremes, Saucen, Suppen usw.
 Antihaftbeschichtung ILAG: ULTIMATE.
 Attraktives Design und funktionelle Beschaffenheit.

Made in cast aluminium.
 It guarantees the absorption and uniform distribution of heat, without overheating points.
 The uniform distribution of heat throughout the product makes keep its juices during cooking, preserving all its nutrients and vitamins.
 The points located under the lid cause the condensation drops to fall back onto the food, forming a permanent and circulating flow and reducing the loss of the food's flavours and juices.
 This is an ideal product for: rice, meats, fish, beans, vegetables, stews, creams, sauces, soups, etc.
 Non-stick coating ILAG: ULTIMATE.
 Attractive design and great functionality.

Fabricadas em alumínio fundido.
 Garantem a absorção e a distribuição uniforme do calor, sem pontos de sobreaquecimento.
 A distribuição uniforme do calor por toda a peça faz com que os alimentos não percam o seu suco durante a cocção, conservando assim todos os seus nutrientes e vitaminas.
 As pontas situadas sob a tampa fazem com que as gotas produzidas pela condensação voltem a cair sobre os alimentos, formando um fluxo circular e permanente, reduzindo a perda de sabores e de líquidos dos alimentos.
 Ideal para cozinhar arroz, carnes, peixos, legumes, verduras, guisados, cremes, molhos, sopas, etc.
 Revestimento antiaderente ILAG: ULTIMATE.
 Design atraente, funcional.



Cacerola con tapa MINI

Faitout avec couvercle "MINI"
"MINI" Bratentopf mit Deckel
"MINI" round casserole with lid
Caçarola com tampa "MINI"



Ref	€	Ø (cm)	h (cm)	L	U.Venta
25909	19,51	10	5,0	0,24	12
25914	28,74	14	7,5	0,90	1

Cacerola con tapa MINI negra

Faitout avec couvercle MINI noir
MINI Bratentopf mit Deckel, grau
"MINI" black round casserole with lid
Caçarola com tampa MINI negra



Ref	€	Ø (cm)	h (cm)	L	U.Venta
25910	19,51	10	5,0	0,24	1
25915	28,74	14	7,5	0,90	1

Cacerola oval con tapa MINI

Faitout Ovale avec couvercle "MINI"
"MINI" Oval Bratentopf mit Deckel
"MINI" oval round casserole with lid
Caçarola oval com tampa "MINI"



Ref	€	cm	h (cm)	L	U.Venta
25911	20,54	12x8,5	5,0	0,25	12

Cacerola oval con tapa MINI negra

Faitout ovale avec couvercle MINI noir
MINI Oval Bratentopf mit Deckel, grau
"MINI" black oval round casserole with lid
Caçarola oval com tampa MINI negra



Ref	€	cm	h (cm)	L	U.Venta
25912	19,40	12x8,5	5,0	0,25	1

Cacerola con tapa

Faitout avec couvercle
Bratentopf mit Deckel
Round casserole with lid
Caçarola com tampa



Ref	€	Ø (cm)	h (cm)	L	U.Venta
25916	42,23	16	7,0	1,30	1
25920	54,99	20	8,0	2,40	1
25924	70,97	24	10,0	4,20	1
25928	90,57	28	11,5	6,70	1

Incluye asas de silicona
Includes silicone handles



Cacerola con tapa negra

Faitout avec couvercle noir
Bratentopf mit Deckel, grau
Black round casserole with lid
Caçarola com tampa negra

Ref	€	Ø (cm)	h (cm)	L	U.Venta
25917	45,90	16	7,0	1,30	1
25921	61,84	20	8,0	2,40	1
25925	77,40	24	10,0	4,20	1
25929	94,72	28	11,5	6,70	1

Cacerola oval con tapa

Faitout Ovale avec couvercle
Oval Bratentopf mit Deckel
Oval round casserole with lid
Caçarola oval com tampa



Ref	€	cm	h (cm)	L	U.Venta
25927	55,36	26x20	9,0	3,50	1
25931	89,85	31x25	11,0	6,30	1

Incluye asas de silicona
Includes silicone handles



Cacerola oval con tapa negra

Faitout ovale avec couvercle noir
Oval Bratentopf mit Deckel, grau
Black oval round casserole with lid
Caçarola oval com tampa negra

Ref	€	cm	h (cm)	L	U.Venta
25933	70,65	26x20	9,0	3,50	1
25935	97,32	31x25	11,0	6,30	1

Si

Silicone

Manoplas de silicona GRIS

Moufettes en silicone
Griffchutz aus Silikon
Silicone mitteln
Pegas de silicone

Ref	€	Ø (cm)	U.Venta
R25917G	7,15	16	6
R25921G	6,74	20-24-28	6
R25933G	7,15	26x20	6
R25935G	6,74	31x25	6



▶ MAGMA GREY & RED



Acabado exterior e interior esmaltado, muy resistente y de gran durabilidad. Muy versátiles: ideal para cocinar asados, arroces, pasta, cocer a fuego lento e incluso hornear tartas dulces y pan. Conserva todos los nutrientes, vitaminas y sabores de los alimentos. Excelente retención y distribución uniforme del calor. Incluye base de madera, ideal para servir y presentar. Aptas para todo tipo de fuegos.

Finición exterior e interior esmaltada. Esmaltado muy resistente y de gran durabilidad. Muy versátiles: ideal para cocinar des migóts, du riz, des pâtes, cuire à feu doux et même enfourner des gâteaux et du pain. Conserva tous les nutriments, les vitamines et les saveurs des aliments. Excellente rétention et distribution uniforme de la chaleur. Inclut une base en bois, idéale pour servir et présenter. Aptes pour tous types de feux.

Esmaltierte Außen- und Innenflächen. Sehr beständige und langlebige Esmaltierung. Sehr vielseitig: ideal zum Kochen, Braten und Garen; zum Bereiten von Nudeln und Reis und sogar zum Kuchen und Brot backen. Erhält Nährstoffe, Vitamine und Geschmack der Nahrungsmittel. Außerst gleichmäßige Wärmeaufnahme und -verteilung. Inkl. Holzuntersatz: ideal zum Servieren und Anrichten. Für alle Herdarten geeignet.

Enamel finish inside and outside. Very strong and durable enamel. Extremely versatile: perfect for roasts, rice, pasta, low heat cooking and even baking bread or cake. Preserves all the nutrients, vitamins and flavours of the food. Excellent heat retention and uniform heat distribution. Wooden base included, perfect for serving or presentation. Appropriate for all kinds of cookers.

Acabamento exterior e interior esmaltado, muito resistente e de grande durabilidade. Grande versatilidade: ideal para cozinhar assados, arroz, massas, cocção a fogo lento e inclusive para cozer no forno tartas doces e pão. Conserva todos os nutrientes, vitaminas e sabores dos alimentos. Excelente retenção e distribuição uniforme do calor. Inclui base de madeira, ideal para servir e apresentar. Aptas para todo o tipo de fogões.

Cacerola redonda GREY

Faitout rond
Rund Bratentopf
Round casserole
Caçarola redonda



Ref	€	Ø (cm)	h (cm)	ml	U.Venta
25841	15,25	12,0	3,0	200	1
25848	23,66	16,2	3,0	470	1
25849	29,47	18,5	3,0	720	1

Cacerola redonda RED

Faitout rond
Rund Bratentopf
Round casserole
Caçarola redonda



Ref	€	Ø (cm)	h (cm)	ml	U.Venta
25851	15,25	12,0	3,0	200	1
25858	23,66	16,2	3,0	470	1
25859	29,47	18,5	3,0	720	1

Cacerola oval GREY

Faitout ovale
Oval Bratentopf
Oval casserole
Caçarola oval



Ref	€	cm	h (cm)	ml	U.Venta
25842	20,34	17,5x12,5	3,0	250	1
25840	29,36	21,7x15	3,0	700	1

Cacerola oval RED

Faitout ovale
Oval Bratentopf
Oval casserole
Caçarola oval



Ref	€	cm	h (cm)	ml	U.Venta
25852	20,34	17,5x12,5	3,0	250	1
25850	29,36	21,7x15	3,0	700	1

Sartón GREY

Poêle
Pfanne
Frying pan
Sertâ



Ref	€	Ø (cm)	h (cm)	ml	U.Venta
25843	15,36	13,5	3,0	275	1

Sartón RED

Poêle
Pfanne
Frying pan
Sertâ



Ref	€	Ø (cm)	h (cm)	ml	U.Venta
25853	15,36	13,5	3,0	275	1

Cacerola rectangular con tapa GREY

Faitout rectangulaire avec couvercle
Bratentopf, rechteckig mit Deckel
Rectangular casserole with lid
Çaçarola rectangular com tampa



Ref	€	cm	h (cm)	ml	U.Venta
25845	28,95	13x9	4,5	300	1

Cacerola rectangular con tapa RED

Faitout rectangulaire avec couvercle
Bratentopf, rechteckig mit Deckel
Rectangular casserole with lid
Çaçarola rectangular com tampa



Ref	€	cm	h (cm)	ml	U.Venta
25855	28,95	13x9	4,5	300	1

Cacerola redonda con tapa GREY

Faitout rond avec couvercle
Rund Bratentopf mit Deckel
Round casserole with lid
Çaçarola redonda com tampa



Ref	€	Ø (cm)	h (cm)	ml	U.Venta
25846	24,69	10	5,0	200	1

Cacerola redonda con tapa RED

Faitout rond avec couvercle
Rund Bratentopf mit Deckel
Round casserole with lid
Çaçarola redonda com tampa



Ref	€	Ø (cm)	h (cm)	ml	U.Venta
25856	24,69	10	5,0	200	1

Cacerola oval con tapa GREY

Faitout ovale avec couvercle
Oval Bratentopf mit Deckel
Oval casserole with lid
Çaçarola oval com tampa



Ref	€	cm	h (cm)	ml	U.Venta
25847	29,36	13x10	5,0	400	1

Cacerola oval con tapa RED

Faitout ovale avec couvercle
Oval Bratentopf mit Deckel
Oval casserole with lid
Çaçarola oval com tampa



Ref	€	cm	h (cm)	ml	U.Venta
25857	29,36	13x10	5,0	400	1



Hierro Fundido
Cast Iron



Construida en una sola pieza.
Recubierta con una capa de aceite vegetal.
Ideal para cocinar, prolonga suavemente la cocción.
Gran conductor del calor, mantiene el calor mientras disfrutas y saboreas la comida.
Base de madera para servir y presentar la comida recién cocinada.

Construite en une seule pièce.
Revêtu d'une couche d'huile végétale.
Idéal pour cuisiner, prolonge délicatement la cuisson.
Grand conducteur de chaleur, maintient le plat au chaud pendant que vous dégustez la nourriture.
Base en bois pour servir et présenter le plat fraîchement cuit.

Aus einem Stück gefertigt.
Beschichtet mit einer Schicht von Pflanzenöl.
Ideal zum Kochen, verlängert den Kochvorgang auf sanfte Weise.
Hervorragender Wärmeleiter, erhält die Wärme während Sie die Speisen genießen.
Holzbase, auf der das soeben zubereitete Gericht serviert und präsentiert wird.

Built in one piece.
Coated with a layer of vegetable oil.
Ideal for cooking, gently continues to cook.
Great heat conductor, retains heat while you enjoy and savour the food.
Wooden base to serve and present freshly cooked food.

Elementos fabricados a partir de uma única peça.
Revestidos com uma camada de óleo vegetal.
Ideal para cozinhar, prolonga suavemente a cocção.
Excelente condutor de calor, mantém o calor enquanto desfruta da comida.
Base de madeira para servir e apresentar a comida recém-preparada.

Cacerola con base

Faitout avec basse
Bratentopf mit Holzsockel
Casserola with base
Caçarola com base



Ref	€	Ø (cm)	ml	U.Venta
25871	13,38	12,5	230	4
25872	18,26	16,2	470	1
25873	23,45	18,5	720	1

Cacerola

Faitout
Bratentopf
Casserola
Caçarola



Ref	€	Ø (cm)	ml	U.Venta
25771	9,23	12,5	230	4
25772	13,49	16,2	470	4
25773	16,29	18,5	720	1

Cacerola oval con base

Faitout ovale avec basse
Oval Bratentopf mit Holzsockel
Oval casserola with base
Caçarola oval com base



Ref	€	cm	ml	U.Venta
25881	13,49	15x10	200	4
25882	20,85	17,5x12,5	300	1
25883	23,24	21,7x15	700	1

Cacerola oval

Faitout ovale
Oval Bratentopf
Oval casserola
Caçarola oval



Ref	€	cm	ml	U.Venta
25781	10,58	15x10	200	4
25782	16,50	17,5x15,2	300	1
25783	18,78	21,7x15	700	1



Mini Plancha Grill lisa rectangular con base
 Mini Plaque Grill lisse rectangulaire avec basse
 Mini Platte Grill, glatt, rechteckiger mit Holzsockel
 Mini rectangular Grill plaque flat with base
 Mini Plancha Grill liso rectangular con base

Mini Plancha Grill lisa rectangular
 Mini Plaque Grill lisse rectangulaire
 Mini Platte Grill, glatt, rechteckiger
 Mini rectangular Grill plaque flat
 Mini Plancha Grill liso rectangular

Ref	€	cm	h (cm)	U.Venta
25874	13,07	17x10	2,5	4

Ref	€	cm	h (cm)	U.Venta
25774	8,92	17x10	2,5	4



Mini Plancha Grill cuadrado c/base
 Mini Plaque Grill carré avec basse
 Mini Platte Grill, Quadrat mit Holzsockel
 Mini square Grill plaque with base
 Mini Plancha Grill cuadrado con base

Mini Plancha Grill cuadrado
 Mini Plaque Grill carré
 Mini Platte Grill, Quadrat
 Mini square Grill plaque
 Mini Plancha Grill cuadrado

Ref	€	cm	h (cm)	U.Venta
25875	13,07	14x14	1,7	4

Ref	€	cm	h (cm)	U.Venta
25775	9,23	14x14	1,7	4



Mini Grill con base
 Mini Grill avec basse
 Mini Grill mit Holzsockel
 Mini Grill with base
 Mini Grill con base

Mini Grill
 Mini Grill
 Mini Grill
 Mini Grill
 Mini Grill

Ref	€	cm	h (cm)	U.Venta
25876	15,04	14x14	2,5	1

Ref	€	cm	h (cm)	U.Venta
25776	9,65	14x14	2,5	4



Mini sartén lisa con base
 Mini poêle lisse avec basse
 Mini Pfanne mit Holzsockel
 Mini frying pan flat with base
 Mini sartã lisa con base

Mini sartén lisa
 Mini poêle lisse
 Mini Pfanne
 Mini frying pan flat
 Mini sartã lisa

Ref	€	Ø (cm)	h (cm)	U.Venta
25877	14,01	13	1,7	1

Ref	€	Ø (cm)	h (cm)	U.Venta
25777	9,75	13	1,7	4

▶ PAELLERA SMALT

Paellera esmaltada SMALT
 Plat à paella
 Paellapfanne, emailiert
 Round dish for paella
 Paellheira esmaltada

Ref	€	Ø (cm)	U.Venta
60170	4,36	10	10
60172	4,88	12	10
60175	5,71	15	6
60180	7,37	20	6

Esmalte vitrificado
 Vitriado enamel



FE Hierro/iron	 Vibra	 Electric	 Gas	 Induction	 Oven	 Glas/ceramic	
--------------------------	-----------	--------------	---------	---------------	----------	------------------	--

Perfectas para presentar y servir tapas, raciones o pinchos
 Perfect for serving or presenting delicious tapas, dishes or pinchos

FONDUE

Asas termoaislantes
Heat-resistant handle



Base de cristal
Glass base

Inox
18/10



Fondue 6 personas con base cristal

Service à Fondue sur socle en verre
Fondue für 6 Personen mit Glasse, Rostfrei
6 People St. Steel Fondue w/glass lazy susan
Fondue 6 pessoas com base vidro

Ref	€	L	U.Venta
71710	133,94	2,00	1

6 pinchos Fondue

Jeu 6 fourchettes à Fondue
6 Fonduespiesse, Rostfrei
6 Pcs. Fondue forks
6 espeltes Fondue

Ref	€	L (cm)	U.Venta
R71710	7,47	24	1



6 cucharas Fondue

Jeu 6 cuillères à Fondue
6 Fondueöffel, Rostfrei
6 Pcs. Fondue spoons
6 colheres Fondue

Ref	€	L (cm)	U.Venta
R71711	7,26	15	1



Taza Inox Fondue

Bol à Fondue
Fonduefasse, Rostfrei
St. Steel Fondue cup
Taça Inox Fondue

Ref	€	Ø Interior (cm)	Ø Exterior (cm)	U.Venta
R71723	2,18	9	8,6	1



GEL

Inox

Contenedor de combustible

Porte-brûleur
Brennpasten-Behälter
Burner holder
Recipiente de combustível



Ref	€	Ø (cm)	h (cm)	L (cm) Asa	U.Venta
69006	20,54	9,0	6,0	7,0	1

Gel de origen orgánico
Organic gel fuel



80 minutos de duración
80 minutes long



Pack 3 latas combustible ETANOL Fondue

Pack de 3 boîtes Gel de chauffe ETHANOL
Brennpasten, ETHYALKOHOL
3 can Fondue burning ETHANOL gel
Pack 3 latas combustible ETANOL Fondue

Ref	€	g	Minutos	U.Venta
71780	4,05	80	80	1

Gel de origen orgánico. No produce emanaciones tóxicas. Encendido rápido y combustión silenciosa, limpia, inodora, sin humos y sin cenizas.
Organic gel fuel. Does not produce toxic fumes. Quick-lighting and quiet burning, clean, odourless, smokeless and ash-free



Gel combustible ETANOL

Gel chauffe ETHANOL
Brennpaste, ETHYALKOHOL
Fuel gel, ETHANOL
Gel combustível ETANOL

	Ref	€	Kg	Horas	U.Venta	
A	69108	2,28	0,225	3	72	Lata - Can
B	69107	7,37	0,840	-	1	Botella - Bottle
C	69109	33,95	4,00	-	1	Bidón - Barrel



Ollas a presión
Pressure Cookers

#CocinaConLacor





Olla a presión
Cocotte à pression
Schnellkochtopf
Pressure cooker
Panela de pressão

Ref	€	Ø (cm)	h (cm)	L	U.Venta
50815	513,25	32	18,0	15,0	1
50818	528,19	32	23,0	20,0	1
50823	554,86	32	32,0	23,0	1



Sistema de apertura y cierre con una sola mano.
Selección de posiciones (3 posiciones: 0 - I - II).
Se puede utilizar como una cacerola normal.

Ouverture et de fermeture d'une seule main.
Sélection positions (3 positions: 0 - I - II).
Peut être utilisé comme une casserole normale.

Das Öffnen und Schließen mit einer Hand.
Auswählen Stellung(en) (3 Position: 0 - I - II).
Kann auch als normaler Topf verwendet werden.

Opening and closing system with one hand.
Selecting positions (3 position: 0 - I - II).
Can be used as a normal casserole.

Sistema de abertura e fechar com uma mão.
A seleção de posições (3 posições: 0 - I - II).
Pode ser usado como uma panela normal.



Cuerpo Olla a presión
Corps Cocotte à pression
Schnellkochtopf-Körper
Pressure cooker stockpot
Corpo panela de pressão

Ref	€	Ø (cm)	h (cm)	L	U.Venta
50816	177,10	32	18,0	15,0	1
50819	192,04	32	23,0	20,0	1
50824	218,71	32	32,0	23,0	1



Tapa
Couvercle
Deckel
Lid
Tampa

Ref	€	Ø (cm)	Año	U.Venta
50933	332,83	32	<2015	1
50934	336,15	32	>2015	1



Tapa
Couvercle
Deckel
Lid
Tampa

Ref	€	Ø (cm)	U.Venta
54932	23,45	32	1

CHEF



Olla a presión
Cocotte à pression
Schnellkochtopf
Pressure cooker
Panela de pressão

Ref	€	Ø (cm)	h (cm)	L	U.Venta
71815	403,90	28	25,0	15,0	1
71821	419,46	28	33,0	20,0	1



Las asas de la olla están diseñadas para una sujeción segura. Sistema de bloqueo para evitar que la olla coja presión en caso de mal acople. Ventana de salida de vapor en la tapa, en caso de fallo de los sistemas de seguridad, esta ventana permite la pérdida de presión.

Les poignées de l'autocuiseur sont conçues pour une fixation sûre. Système de blocage pour éviter que la cocotte se remplisse de pression en cas de mauvais ajustement. Fenêtre de sortie de vapeur sur le couvercle. En cas de dysfonctionnement des systèmes de sécurité, cette fenêtre permet d'évacuer la pression.

Die Griffe Schnellkochtöpfe sind für einen festen Verschluss ausgelegt. Blockiersystem zur Vermeidung des Druckaufbaus bei nicht korrekt aufgesetztem Deckel. Dampfaustrittsfenster, falls die Sicherheitsvorrichtungen ausfallen, kann der Dampf über dieses Fenster entweichen.

The handles of the cooker are designed with safety interlock. Locking system to prevent the cooker from gaining pressure if it has not been properly closed. Steam output window in the lid; in the event that the security systems fail, this window enables pressure to be released.

As asas da panela foram desenhadas com uma fixação segura. Sistema de bloqueio, que evita que a panela acumule pressão ao estiver mal fechada. Janela de saída de vapor na tampa; em caso de falha dos sistemas de segurança, permite a saída da pressão.

ROBUST



Olla a presión
Cocotte à pression
Schnellkochtopf
Pressure cooker
Panela de pressão

Ref	€	Ø (cm)	h (cm)	L	U.Venta
20830	1.168,02	42	31	30	1
20840	1.245,52	42	39	40	1
20850	1.323,33	42	46	50	1



Para uso profesional.
Fabricada en aluminio de máxima calidad (grado de pureza 99,55%).
Diseño elegante, selecto, de gran durabilidad.
Triple sistema de seguridad.
Ahorro de tiempo y energía (Reduce los tiempos de cocción hasta un 70%).
Punto más robusto y resistente. Asas de baquelita antiquemaduras.

À usage professionnel.
Il est conçu en aluminium haute qualité (degré de pureté de 99,5 %).
Design élégant, sélect, d'une grande durabilité.
Triple système de sécurité.
Gain de temps et économie d'énergie (réduit les durées de cuisson jusqu'à 70%).
Pont plus robuste et résistant. Poignées en bakélite anti-brûlures.

Für den gewerblichen Gebrauch.
Aus hochwertigem Aluminium (mit einem Reinheitsgrad von 99,5 %) gefertigt.
Elegantes, ausgesuchtes Design und äußerst robust.
Dreifaches Sicherheitssystem.
Zeit- und Energieersparnis (die Garzeiten werden um bis zu 70% reduziert).
Mehr robust und widerstandsfähig Brücke. Wärmeisolierte Bakelitgriffe.

For professional use.
Made of high quality aluminium (with a 99.5% degree of purity).
Elegant, exclusive and highly durable design.
Triple safety system.
Time and energy saving (Reduces cooking times by up to 70%).
The safety pressure release valve is activated if the pressure valve fails.
More robust, and resistant bridge.

Para uso profissional.
Fabricada em alumínio da máxima qualidade, (grau de pureza é de 99,5 %).
Design elegante e exclusivo, de grande durabilidade.
Triplo sistema de segurança.
Poupa tempo e energia (reduz os tempos de cocção até 70%).
Ponto mais robusto e resistente. Asas de baquelite anti-queimaduras.

► PRO-CLASSIC



Fabricada en aluminio puro
Manufactured in pure aluminium



Olla a presión

Cocotte à pression
Schnellkochtopf
Pressure cooker
Panela de pressão

Ref	€	Ø (cm)	h (cm)	L	U.Venta
20511	90,06	28	22	11,0	1
20515	103,54	30	25	15,0	1
20518	128,86	32	23	18,0	1
20522	143,18	34	23	22,0	1
20533	171,19	36	32	33,0	1



Para uso profesional.

Válvula de presión/contrapeso, permite que se libere el vapor regulando la presión interior de la olla.
Válvula de seguridad - despresurización, actúa si la válvula de presión falla.
Puente más robusto y resistente. Asas de baquelita antiquemaduras.

A usage professionnel.

Soupe à pression/contrepois, permet de libérer la vapeur en régulant la pression intérieure de l'autocuiseur.
Soupape de sécurité - dépressurisation, agit dans le cas d'un dysfonctionnement de la soupape à pression.
Pont plus robuste et résistant. Poignées en bakélite anti-brûlures.

Für den gewerblichen Gebrauch

Druckventil/Ausgleichventil: Regalt den Innendruck, indem Dampf nach außen geleitet werden kann.
Sicherheitsventil: Führt den Druckausgleich aus, wenn das Druckventil versagt.
Mehr robust und widerstandsfähig Brücke. Wärmeisolierte Bakelitgriffe.

For professional use.

The pressure/counterweight valve lets steam escape and regulates pressure inside the pot.
The safety - pressure release valve is activated if the pressure valve fails.
More robust and resistant bridge. Anti-scald Bakelite Handles.

Para uso profissional.

Válvula de pressão/contrapeso, que permite a libertação do vapor regulando a pressão interior da panela.
Válvula de segurança - despressurização, atua em caso de falha da válvula de pressão.
Ponte mais robusto e resistente. Asas de baquelite anti-queimaduras.

► CLASSIC



Fabricada en acero inoxidable 18/10 de máxima calidad.

Marcaje interior, grabado con la capacidad del uso de la olla.
Asas de baquelita antiquemaduras. Válvula de seguridad.

Apta para todo tipo de cocinas. Triple fondo FULL INDUCTION para una distribución rápida y homogénea del calor.

* Las referencias 71872-71875 contienen un cestillo.

Fabrication en acier inoxydable 18/10 de qualité maximale.

Marquage intérieur, marqué avec la capacité d'utilisation de l'autocuiseur.
Poignées en bakélite anti-brûlures. Soupape de sécurité.

Adapté pour tout type de feux. Triple fond FULL INDUCTION pour une distribution rapide et homogène de la chaleur.

* Les références 71872-71875 contiennent un panier.

Material: Edelstahl 18/10 bester Qualität; mit Hochglanzschliff an der Außenseite.
Innenmarkierung, füllstandsanzeige mit Min-Max-Gravierung.

Wärmeisolierte Bakelitgriffe. Sicherheitsventil.
Für alle möglichen Kochstellen geeignet. Dreifacher Boden FULL INDUCTION für eine schnelle und gleichförmige Hitzeverteilung.

* In den Artikeln 71872-71875 ist ein Korb im Lieferumfang enthalten.

Manufactured in high-quality 18/10 stainless steel.

Inner marking, engraved with the cooker's capacity.

Burn-resistant Bakelite handles. Safety valve.

Suitable for any type of hot. Tri-pty FULL INDUCTION base for quick, even heat distribution.

* The 71872-71875 references contain a basket.

Fabricada em aço inoxidável 18/10 de máxima qualidade.

Marcação interior, gravação com a capacidade de uso da panela.

Asas de baquelite anti-queimaduras. Válvula de segurança.

Utilizável com todo o tipo de fogões. Fundo triplo FULL INDUCTION para uma distribuição rápida e homogénea do calor.

* As referências 71872-71875 incluem um cesto.



Olla a presión

Cocotte à pression
Schnellkochtopf
Pressure cooker
Panela de pressão

Ref	€	Ø (cm)	h (cm)	L	U.Venta
71874	73,14	22	11,5	4,0	1
71876	80,30	22	17,0	6,0	1
71878	87,77	24	19,0	8,0	1
71871	95,66	24	23,0	10,0	1
71872	150,85	26	23,0	12,0	1 *
71875	162,47	26	29,0	15,0	1 *

▶ MASTER



Exterior acabado pulido espejo
Exterior mirror-polished finish

Baquelita antiquemaduras
Burn-resistant Bakelite handles



Olla a presión

Cocotte à pression
Schnellkochtopf
Pressure cooker
Panela de pressão

Ref	€	Ø (cm)	h (cm)	L	U.Venta
71884	68,27	22	15,5	4,0	1
71886	74,08	22	22,0	6,0	1
71887	89,23	24	23,5	8,0	1



Fabricada en acero inoxidable 18/10 de máxima calidad.
Marcaje interior, grabado con la capacidad del uso de la olla.
Visualizador de los niveles de cocción mediante anillos de colores
2 niveles de cocción: Rápida (verduras, hortalizas y pescados).
Super rápida (carnes y estofados).

Válv. de seguridad - Sist. de bloqueo de seguridad - Ventanas laterales de seguridad.
Apta para todo tipo de cocinas. Fondo FULL INDUCTION.

Fabrication en acier inoxydable 18/10 de qualité maximale.
Marquage intérieur, marqué de la capacité d'utilisation de l'autocuiseur.
Visualisateur des niveaux de cuisson via anneaux de couleur
2 niveaux de cuisson : Rapide (légumes et les poissons)
Super rapide (viandes et les ragouts)
Soupape de sécurité - Syst. de blocage de sécurité - Fenêtres latérales de sécurité.
Apte pour tout type de feux. Fond FULL INDUCTION

Materia, Edelstahl 18/10 bester Qualität.
Innenmarkierung, füllstandsanzeige mit Min-Max-Gravierung
Anzeige der Garstufen mittels farbigen Ringmarkierungen.
2 Garstufen: Schnell (Fehl- und Gartengemüse sowie Fleisch)
Sehr schnelle (Speisen wie Fleischgerichte).
Sicherheitsventil - Deckelverriegelung - Seitliche Sicherheitsfenster.
Für alle möglichen Kochstellen geeignet. Boden FULL INDUCTION.

Manufactured in high quality 18/10 stainless steel.
Inner marking, engraved with the cooker's capacity
Cooking level indicator - display using coloured rings.
2 cooking levels: Fast (vegetables and fish)
Super fast (meats and stews)
Safety valve - Safety locking system - Side safety windows
Suitable for any type of hob - FULL INDUCTION base.

Fabricada em aço inoxidável 18/10 de máxima qualidade.
Marcação interior, gravação com a capacidade de uso da panela.
Visualizador dos níveis de cocção com anéis de cor.
2 níveis de cocção: Rápida (verduras, hortaliças e peixes).
Super rápida (carnes e estofados).
Válv. de segurança - Sist. de bloqueio de segurança - Janelas laterais de segurança.
Utilizável com todo o tipo de fogões. Fundo FULL INDUCTION.

▶ TEMPO



Baquelita antiquemaduras
Burn-resistant Bakelite handles



Olla a presión

Cocotte à pression
Schnellkochtopf
Pressure cooker
Panela de pressão

Ref	€	Ø (cm)	h (cm)	L	U.Venta
71864	75,01	22	15,0	4,0	1
71866	77,09	22	23,0	6,0	1
71868	82,90	22	27,0	8,0	1



Fabricada en acero inoxidable 18/10 de máxima calidad.
Marcaje interior, grabado con la capacidad del uso de la olla.
Válvula de control para seleccionar el nivel de presión.
Niveles de cocción: cocción lenta y cocción rápida.
Válvula de seguridad - Sistema de bloqueo de seguridad - Ventanas laterales de seguridad.
Apta para todo tipo de cocinas. Triple fondo FULL INDUCTION para una distribución rápida y homogénea del calor.

Manufactured in high quality 18/10 stainless steel.
Inner marking, engraved with the cooker's capacity
Control valve for selecting the power level.
Cooking levels: slow cooking and fast cooking.
Safety valve - Safety locking system - Side safety windows.
Suitable for any type of hob - Tri-ply FULL INDUCTION base for quick, even heat distribution.

Set de ollas a presión 6-4 L

Ensemble de cocottes à pression 6-4 L
Schnellkochtopf-Satz, 6-4 L
Set of 6-4 L pressure cooker
Conj. de panelas de pressão 6-4 L



Ref	€	Ø (cm)	h (cm)	L	U.Venta
71862	117,65	22	16,0	6,0	1
		22	12,0	4,0	

Sartenes
FryPans

#CocinaConLacor



CHEF-INOX



Fabricadas en acero inoxidable 18/10 de la mejor calidad.
Máxima garantía en resistencia, durabilidad e higiene.
Acabado interior y exterior lijado satinado.
Fondo termodifusor sandwich, distribución rápida y uniforme del calor.
Homogeneidad y eficacia térmica. Cocción ultra-rápida.
Aptas para todos los fuegos.

Fabriquées en acier inoxydable 18/10 de la meilleure qualité.
Garantie maximale de résistance, de durabilité et d'hygiène.
Finition interne et externe en brossage satiné.
Fond thermo-diffuseur sandwich, distribution rapide et uniforme de la chaleur.
Homogénéité et efficacité thermique. Cuisson ultra-rapide.
Aptes pour tous les feux.

Aus Edelstahl 18/10 bester Qualität.
Garantiert robust, langlebig und hygienisch.
Außen- und Innenseite in matterm Schliß.
Wärmeleitender Sandwichboden, schnelle und gleichmäßige Wärmeverteilung.
Gleichförmigkeit und thermische Effektivität. Ultraschnelles Garen.
Für alle Herdarten geeignet.

Maximum guaranteed in resistance, durability and hygiene.
Glossy sanded interior and exterior finish.
Heat-diffusing sandwiched base, quick and even heat distribution.
Thermal homogeneity and efficiency. Ultra-rapid cooking.
Suitable for all types of cookers.

Fabricadas em aço inoxidável 18/10 de melhor qualidade.
Máxima garantia de resistência, durabilidade e higiene.
Acabamento interior e exterior acedado.
Função termodifusor tipo sanduiche, que assegura uma distribuição rápida e uniforme do calor.
Homogeneidade e eficácia térmica. Coccão ultra-rápida.
Aptas para todos os fogões.



Antiaderente - Non-stick
ECLIPSE PLUS



Sartén CHEF-INOX PLUS

Poêle
Pfanne
Frying-pan
Sertã

Ref	€	Ø (cm)	h (cm)	e (mm)	U.Venta
51621	42,75	20	4,0	1,0	1
51625	47,93	24	4,5	1,0	1
51629	57,79	28	5,5	1,0	1
51633	71,80	32	6,0	1,0	1
51637	92,96	36	6,5	1,0	1
51641	108,32	40	6,5	1,0	1

Sartén CHEF-INOX

Poêle
Pfanne
Frying-pan
Sertã



Ref	€	Ø (cm)	h (cm)	e (mm)	U.Venta
51620	34,86	20	4,0	1,0	1
51624	38,49	24	4,5	1,0	1
51628	46,58	28	5,5	1,0	1
51632	55,82	32	6,0	1,0	1
51636	70,03	36	6,5	1,0	1
51640	83,83	40	6,5	1,0	1



Acabado cerámico
Ceramic finished



Sartén CHEF-INOX CERAM

Poêle
Pfanne
Frying-pan
Sertã

Ref	€	Ø (cm)	h (cm)	e (mm)	U.Venta
51720	44,30	20	4,0	1,0	1
51724	50,22	24	4,5	1,0	1
51728	60,59	28	5,5	1,0	1
51732	75,63	32	6,0	1,0	1
51736	93,69	36	6,5	1,0	1
51740	109,77	40	6,5	1,0	1

▶ ALUMINIO

New



Sartenes fabricadas en aluminio de máxima calidad diseñadas para uso profesional. Óptima distribución del calor conservando las propiedades nutritivas de los alimentos, con un mínimo gasto de aceite y energía. Recubrimiento antiadherente Multi-capa PEEK. Ecológico, libre de materiales tóxicos y pesados. Libre de PFOA. Ideales para un uso continuo. Ligeras, ergonómicas y fáciles de limpiar. Aptas para todo tipo de cocinas, excepto inducción.

Poêles fabricades en aluminiu de granda qualitat concebudes pour un usage professionnel. Distribucion optima de la chaleur en conservant les propriétés nutritives des aliments, avec une utilisation d'huile et d'énergie minimales. Revêtement antiadhésif multicouche PEEK. Écologique, exempt de matériaux toxiques et lourds. Sans PFOA. Idéales pour un usage continu. Légères, ergonomiques et faciles à nettoyer. Compatible tous feux sauf induction, excepté induction.

Pfannen aus qualitativem Aluminium für professionellen Gebrauch. Optimale Wärmeverteilung bewahrt Nährwert der Speisen und verbraucht wenig Energie und Öl. Umweltfreundlich mehrlagige Antifhaftbeschichtung PEEK. Ökologisch, frei von giftigen und schweren Stoffen. Ohne PFOA. Ideal für dauernden Einsatz. Leicht, ergonomisches und einfach zu reinigen. Für alle Herdarten mit Ausnahme von Induktion geeignet.

Pans made in top quality aluminium and design for professional use. Optimal heat distribution, preserving the nutritional properties, with a minimal waste of oil and energy. Multi-layer non-stick coating PEEK. Ecological, free of toxic and heavy materials. PFOA free. Ideal for continuous use. Light, ergonomic and easy to clean. Suitable for all types of cooking surfaces, except induction.

Sartãs fabricadas em alumínio de máxima qualidade, pensadas para uso profissional. Ótima distribuição do calor, conservando as propriedades nutritivas dos alimentos, reduzindo ao mínimo o gasto de óleo e de energia. Revestimento antiaderente multicapa PEEK. Ecológica, livre de materiais tóxicos e pesados. Livre de PFOA. Ideais para um uso contínuo. Leves, ergonómicas e fáceis de limpar. Aptas para todo o tipo de fogões (exceto placas de indução).



Sartén PREMIUM con mango de silicona

Poêle avec poignée en silicone.
Pfanne, Stiel mit Silikon-Griffschutz.
Frying-pan with silicone handle.
Sartã com alça de silicone

Ref	€	Ø (cm)	h (cm)	e (mm)	U. Venta
23120	26,98	20	4,0	3,5	6
23124	32,16	24	4,5	3,5	6
23126	36,31	26	4,5	4,0	6
23128	40,36	28	4,5	4,0	6
23132	48,56	32	4,7	4,0	6
23136	59,03	36	5,5	4,0	4

Sin mango de silicona * Without silicon handle



Recubrimiento antiadherente PEEK de alta calidad. Resistente a arañazos y ralladuras. Apta para utensilios metálicos.



High quality scratch and scrape resistant PEEK non-stick coating. Extremely resistant to high temperatures. Suitable for metal utensils.



Mango protector de silicona de alta calidad. Fácil de colocar, se ajusta perfectamente al mango. Antideslizante y termo resistente, protege de las temperaturas elevadas.

High quality protective silicone handle. Easy to put on, it fits the handle perfectly. Non-slip and heat-resistant, it protects from high temperatures.



Sartén DYNAMIC

Poêle
Eisen-Pfanne
Frying-pan
Sertã



Ref	€	Ø (cm)	h (cm)	e (mm)	U.Venta
23416	12,45	16	3,5	2,5	6
23418	13,49	18	3,5	2,5	6
23420	16,08	20	4,0	3,5	6
23422	18,78	22	4,0	3,5	6
23424	20,85	24	4,5	3,5	6
23426	24,90	26	4,5	4,0	6
23428	26,98	28	4,5	4,0	6
23432	32,47	32	4,7	4,0	6
23436	41,81	36	5,5	4,0	4



Sartén DYNAMIC +mango de silicona

Poêle avec poignée en silicone
Pfanne, Stiel mit Silikon-Griffschutz
Frying-pan with silicone handle
Sertã com alça de silicone



Ref	€	Ø (cm)	h (cm)	e (mm)	U.Venta
23420M	18,68	20	4,0	3,5	6
23422M	21,58	22	4,0	3,5	6
23424M	23,03	24	4,5	3,5	6
23426M	27,81	26	4,5	4,0	6
23428M	28,95	28	4,5	4,0	6
23432M	34,65	32	4,7	4,0	6



Sartén con fondo TRICAPA PLUS

Poêle avec fond
Pfanne mit Boden
Frying-pan with bottom
Sertã com fundo



Ref	€	Ø (cm)	h (cm)	e (mm)	U.Venta
21718	24,59	18	3,8	2,5	6
21720	28,01	20	4,0	3,5	6
21722	29,57	22	4,0	3,5	6
21724	32,79	24	4,5	3,5	6
21726	38,18	26	4,5	4,0	6
21728	40,98	28	4,5	4,0	6
21732	47,62	32	4,7	4,0	6
21736	58,20	36	5,5	4,0	4



Sartén con fondo TRICAPA PLUS con mango de silicona

Poêle avec poignée en silicone
Pfanne, Stiel mit Silikon-Griffschutz
Frying-pan with silicone handle
Sertã com alça de silicone



Ref	€	Ø (cm)	h (cm)	e (mm)	U.Venta
21718M	27,29	18	3,8	2,5	6
21720M	30,40	20	4,0	3,5	6
21722M	31,54	22	4,0	3,5	6
21724M	35,07	24	4,5	3,5	6
21726M	41,19	26	4,5	4,0	6
21728M	42,33	28	4,5	4,0	6
21732M	50,42	32	4,7	4,0	6



Sartén CHEF-TRICAPA

Poêle
Pfanne
Frying-pan
Sertã



Ref	€	Ø (cm)	h (cm)	e (mm)	U.Venta
21618	22,20	18	3,8	2,5	6
21620	24,28	20	4,0	3,5	6
21622	26,56	22	4,0	3,5	6
21624	29,36	24	4,5	3,5	6
21626	32,47	26	4,5	4,0	6
21628	36,04	28	4,5	4,0	6
21632	43,68	32	4,7	4,0	6
21636	51,98	36	5,5	4,0	4
21640	60,28	40	5,5	4,0	4



Sartén con fondo ECO-CHEF

Poêle avec fond
Pfanne mit Boden
Frying-pan with bottom
Sertã com fundo

Acabado cerámico
Ceramic finish



Ref	€	Ø (cm)	h (cm)	e (mm)	U.Venta
22718	26,46	18	3,8	2,5	6
22720	29,98	20	4,0	3,5	6
22722	32,79	22	4,0	3,5	6
22724	34,96	24	4,5	3,5	6
22726	40,57	26	4,5	4,0	6
22728	44,09	28	4,5	4,0	6
22732	51,77	32	4,7	4,0	6
22736	60,90	36	5,5	4,0	4

▶ ROBUST



Mango protector de silicona de alta calidad. Fácil de colocar, se ajusta perfectamente al mango. Antideslizante y termo resistente, protege de las temperaturas elevadas.

High quality protective silicone handle. Easy to put on, it fits the handle perfectly. Non-slip and heat-resistant, it protects from high temperatures.



Sartén ROBUST

Poêle
Pfanne
Frying-pan
Sertã

Ref.	€	Ø (cm)	h (cm)	e (mm)	U.Venta
23616	12,45	16	3,5	2,5	6
23618	13,49	18	3,5	2,5	6
23620	16,09	20	4,0	3,5	6
23622	18,78	22	4,0	3,5	6
23624	20,85	24	4,5	3,5	6
23626	24,90	26	4,5	4,0	6
23628	26,98	28	4,5	4,0	6
23632	32,47	32	4,7	4,0	6
23636	41,81	36	5,5	4,0	4
23640	49,18	40	5,5	4,0	4



Sartenes fabricadas en aluminio de máxima calidad diseñadas para uso profesional. Óptima distribución de calor conservando las propiedades nutritivas de los alimentos y con un mínimo gasto de aceite y energía. Recubrimiento antiadherente Multi-capa (5 capas) ecológico y libre de PFOA. Ideales para un uso continuo. Ligeras, manejables y fáciles de limpiar gracias a su antiadherente exterior. Aptas para todo tipo de cocinas, excepto inducción.

Poêles fabricadas em alumínio de grande qualidade concebidas para um usage profissional. Distribuição ótima de la chaleur en conservant les propriétés nutritives des aliments et avec une utilisation d'huile et d'énergie minimales. Revêtement antiadhésif multicouche (5 couches) écologique et sans PFOA. Idéales pour un usage continu. Légères, maniables et faciles à nettoyer grâce à leur revêtement antiadhésif extérieur. Compatibles avec tout type de cuisinière, excepté l'induction.

Pfannen aus qualitativstem Aluminium für professionellen Gebrauch. Optimale Wärmeverteilung bewahrt Nährwert der Speisen und verbraucht wenig Energie und Öl. Umweltfreundliche mehrlagige Antihafbeschichtung (5 Lagen) ohne PFOA. Ideal für dauernden Einsatz. Leicht, handlich und einfach zu reinigen dank Antihafbeschichtung an der Außenseite. Für alle Herdarten mit Ausnahme von Induktion geeignet.

Pans made in top quality aluminium and design for professional use. Optimal heat distribution, preserving the nutritional properties and with a minimal waste of oil and energy. Multi-layer (5 layers) eco-friendly non-stick coating, PFOA-free. Ideal for continuous use. Light, easy handling and easy to clean due to its nonstick exterior. Suitable for all types of cooking surfaces, except induction.

Sertãs fabricadas em alumínio de máxima qualidade, pensadas para uso profissional. Ótima distribuição do calor, conservando as propriedades nutritivas dos alimentos, e reduzindo ao mínimo o gasto de óleo e de energia. Revestimento antiaderente multicapa (5 capas), ecológico e sem PFOA. Ideais para um uso contínuo. Leves, fáceis de manipular e de limpar, graças ao seu revestimento exterior antiaderente. Aptas para todo o tipo de fogões (exceto placas de indução).



Sartén ROBUST con mango de silicona

Poêle avec poignée en silicone
Pfanne, Sertã mit Silikon-Griffschutz
Frying-pan with silicone handle
Sertã com alça de silicone

Ref.	€	Ø (cm)	h (cm)	e (mm)	U.Venta
23620M	18,88	20	4,0	3,5	6
23622M	21,48	22	4,0	3,5	6
23624M	23,66	24	4,5	3,5	6
23626M	27,49	26	4,5	4,0	6
23628M	29,78	28	4,5	4,0	6
23632M	35,38	32	4,7	4,0	6



Sartén ROBUST PLUS

Poêle
Pfanne
Frying-pan
Sertã

Ref.	€	Ø (cm)	h (cm)	e (mm)	U.Venta
23816	14,01	16	3,5	2,5	6
23818	14,94	18	3,5	2,5	6
23820	18,05	20	4,0	3,5	6
23822	20,34	22	4,0	3,5	6
23824	22,62	24	4,5	3,5	6
23826	26,15	26	4,5	4,0	6
23828	30,50	28	4,5	4,0	6
23832	35,38	32	4,7	4,0	6
23836	43,37	36	5,5	4,0	4
23840	52,39	40	5,5	4,0	4

Sartén Blinis ROBUST

Poêle Blinis
Pfanne Blinis
Frying-pan Blinis
Sertã Blinis



Ref	€	Ø (cm)	h (cm)	e (mm)	U.Venta
23612	9,65	12	2,1	2,5	6
23614	11,31	14	2,2	2,5	6

Sartén Oval Robust Aluminio

Poêle oval Robust aluminium
Pfanne Robust, oval, Aluminium
Oval frying-pan robust aluminium
Sertã oval Robust Aluminio



Ref	€	cm	h (cm)	e (mm)	U.Venta
23637	53,74	36x26	5,0	2,7	1
23641	55,92	40x29	5,5	2,7	1

Sartén Rectangular Robust Alum.

Poêle-rectangulière Robust alum.
Pfanne Robust, rechteckig
Rectangular frying-pan Robust alum
Sertã rectangular Robust Alum



Ref	€	cm	h (cm)	e (mm)	U.Venta
23638	47,10	38x26	5,0	4,0	1

* Compatible con nuestro mango de silicona (Ref.: 23900)
Compatible with our silicone handle (Ref.: 23900)

Wok Robust Aluminio

Wok Robust aluminium
Wok Robust, Aluminium
Robust wok aluminium
WokRobust Aluminio



Ref	€	Ø (cm)	h (cm)	e (mm)	U.Venta
23830	36,94	30	7,0	4,0	1

* Compatible con nuestro mango de silicona (Ref.: 23900)
Compatible with our silicone handle (Ref.: 23900)

Crepera Robust Aluminio

Crêpière Robust aluminium
Crêpes Pfanne, Aluminium
Crepiere Robust aluminium
Crepeira Robust Aluminio



Ref	€	Ø (cm)	h (cm)	e (mm)	U.Venta
23322	15,25	22	1,8	2,5	1
23326	19,19	26	1,8	2,7	1
23330	27,70	30	2,2	4,0	1

* Compatible con nuestro mango de silicona (Ref.: 23900)
Compatible with our silicone handle (Ref.: 23900)



Disfruta de una sartén para toda la vida.
Fabricadas artesanalmente con 100% hierro natural.
Calidad Premium; duraderas y resistentes a arañazos.
Alta conductividad térmica. El hierro al ser un excelente conductor del calor, permite conseguir y mantener la temperatura ideal de cocción con un menor consumo energético.
Espesor 2,5 mm. Fácil limpieza. Cocina ecológica, cocina saludable.
Antiadherente premium, libre de PFOA (sartén antiadherente).

Une poêle qui vous durera toute la vie.
Fabriquées de façon artisanale avec 100% de métal naturel.
Qualité Premium; durables et résistantes aux rayures.
Haute conductivité thermique. Le métal, excellent conducteur de chaleur, permet d'obtenir et de maintenir la température de cuisson idéale avec une consommation d'énergie moins importante.
Épaisseur 2,5mm. Nettoyage facile. Cuisine écologique, cuisine saine.
Antiadhésif premium, sans PFOA (Poêle antiadhérent).

Eine Pfanne an der Sie lobenslang Freude haben.
Von Hand aus 100% natürlichem Eisen hergestellt.
Premiumqualität - langlebig und kratzfest!
Hohe Wärmeleitfähigkeit! Sehr stark wärmeleitendes Eisen sorgt für anhaltend ideale Kochtemperatur bei geringem Energieverbrauch.
2,5 mm dick. Einfach zu reinigen. Umweltfreundliche und gesunde Küche.
Antihaft Premium ohne PFOA (Eisen Pfanne, Antihaft).

Enjoy this one pan your whole life.
Hand-made in 100% natural iron.
Premium Quality, long lasting and resistant to scratching.
High heat conduction. Iron is an excellent conductor of heat, allowing you to obtain and maintain the ideal temperature with less energy consumption.
2.5mm thickness. Easy to clean. Eco-friendly, healthy kitchen.
Premium Quality, long lasting and resistant to scratching (Non-stick frying pan).

Desfruta de uma sartã para toda a vida.
Fabricadas artesanalmente, 100% ferro natural.
Qualidade Premium, de longa duração e resistentes aos riscos.
Alta condutividade térmica. Ao ser um excelente condutor do calor, o ferro permite alcançar e manter a temperatura ideal da cocção com um menor consumo energético.
Espessura de 2,5 mm. Fácil limpeza. Cozinha ecológica, cozinha saudável e energética.
Antiaderente Premium, sem PFOA (sartã anti-aderente).



Sartén FERRUM

Poêle
Pfanne
Frying-pan
Sertã

Ref	€	Ø (cm)	h (cm)	e (mm)	U.Venta
• 63620	19.71	20	3,5	2,5	1
• 63624	22.72	24	4,5	2,5	1
• 63626	24.49	26	4,5	2,5	1
• 63628	25.83	28	5,0	2,5	1
• 63632	30.92	32	5,3	2,5	1
• 63636	39.43	36	5,5	2,5	1
• 63640	43.68	40	5,8	2,5	1

* Compatible with our silicone handle (Ref.: 23900)
Compatible with our silicone handle (Ref.: 23900)



Sartén antiadherente FERRUM

Poêle antiadhérent
Pfanne, Antihaft
Frying-pan, non-stick
Sertã anti-aderente

Ref	€	Ø (cm)	h (cm)	e (mm)	U.Venta
• 63720	22.31	20	3,5	2,5	1
• 63724	24.49	24	4,5	2,5	1
• 63726	26.25	26	4,5	2,5	1
• 63728	27.70	28	5,0	2,5	1
• 63732	32.58	32	5,3	2,5	1
• 63736	41.19	36	5,5	2,5	1
• 63740	47.62	40	5,8	2,5	1

* Compatible with our silicone handle (Ref.: 23900)
Compatible with our silicone handle (Ref.: 23900)

Sartén honda FERRUM

Poêle profonde
Tiefe Pfanne
Deep frying pan
Sertã funda



Ref	€	Ø (cm)	h (cm)	e (mm)	U.Venta
• 63424	33,30	24	7,0	2,5	1
• 63428	38,60	28	8,0	2,5	1
• 63432	56,96	32	8,8	2,5	1

Con asa With handle

* Compatible con nuestro mango de silicona (Ref.: 23900)
Compatible with our silicone handle (Ref.: 23900)

Cazo bombado FERRUM

Casserole bombée
Kasserolle, Bauchig
Rounded saucepan
Çaçarola bojuda



Ref	€	Ø (cm)	h (cm)	e (mm)	U.Venta
• 63419	30,61	20	10	2,5	1
• 63423	38,60	24	12	2,5	1

* Compatible con nuestro mango de silicona (Ref.: 23900)
Compatible with our silicone handle (Ref.: 23900)

Sartén Blinis FERRUM

Poêle Blinis
Blinis Pfanne
Blinis frying pan
Sertã Blinis



Ref	€	Ø (cm)	h (cm)	e (mm)	U.Venta
63613	16,60	12	2,1	2,0	6
63614	18,57	14	2,2	2,0	6



Sartén Blinis antiadherente FERRUM

Poêle Blinis antiadherent
Blinis Pfanne, Antihalt
Blinis frying pan, Non-stick
Sertã Blinis anti-aderente



Ref	€	Ø (cm)	h (cm)	e (mm)	U.Venta
63712	17,53	12	2,1	2,0	6
63714	19,30	14	2,2	2,0	6

Asador FERRUM

Rôtissoire
Grill
Rotisserie
Grelhador



Ref	€	Ø (cm)	h (cm)	e (mm)	U.Venta
• 63725	24,80	26	3,0	2,5	1

* Compatible con nuestro mango de silicona (Ref.: 23900)
Compatible with our silicone handle (Ref.: 23900)



Asador antiadherente

Rôtissoire, antiadherent
Grill, Antihalt
Non-stick rotisserie
Grelhador anti-aderente



Ref	€	Ø (cm)	h (cm)	e (mm)	U.Venta
• 63727	25,52	26	3,0	2,5	1

* Compatible con nuestro mango de silicona (Ref.: 23900)
Compatible with our silicone handle (Ref.: 23900)

Asas de acero inoxidable
Stainless steel handles



Paellera FERRUM

Plat à paella
Paellapfanne
Round dish for paella
Paelheira

Ref	€	Ø (cm)	h (cm)	e (mm)	Raciones	U.Venta
63928	37,87	28	4,5	2,5	3	1
63932	42,95	32	4,7	2,5	5	1
63936	53,54	36	5,3	2,5	7	1
63940	59,03	40	5,5	2,5	9	1

New

Asas de acero inoxidable
Stainless steel handles



Plancha Grill lisa
Plaque à Grill lisse
Platte Grill, glatt
Grill flat plaque
Plancha Grill lisa

Ref	€	cm	h (cm)	e (mm)	U.Venta
63642	45.96	37 x 27	5,0	2,5	1

New

Asas de acero inoxidable
Stainless steel handles



Plancha Grill
Plaque à Grill
Platte Grill
Grill plaque
Plancha Grill

Ref	€	cm	h (cm)	e (mm)	U.Venta
63644	48.76	37 x 27	5,0	2,5	1

Wok
Wok
Wok
Wok
Wok



Ref	€	Ø (cm)	h (cm)	e (mm)	U.Venta
63828	32.16	28	8,0	2,0	1

* Compatible con nuestro mango de silicona (Ref.: 23900)
Compatible with our silicone handle (Ref.: 23900)



Wok antiadherente
Wok, Antiadherent
Wok, Antihalt
Wok, non-stick
Wok anti-aderente



Ref	€	Ø (cm)	h (cm)	e (mm)	U.Venta
63829	33.41	28	8,0	2,0	1

* Compatible con nuestro mango de silicona (Ref.: 23900)
Compatible with our silicone handle (Ref.: 23900)



Crepera antiadherente
Crepiera, antiadherent
Crêpes-Planne, Antihalt
Crepiera, Non-stick
Crepeira anti-aderente



Ref	€	Ø (cm)	h (cm)	e (mm)	U.Venta
23323	18.05	22	1,8	2,5	1
23327	20.65	26	2,2	2,5	1

* Compatible con nuestro mango de silicona (Ref.: 23900)
Compatible with our silicone handle (Ref.: 23900)



Wok antiadherente
Wok, Antiadherent
Wok, Antihalt
Wok, Non-stick
Wok anti-aderente



Ref	€	Ø (cm)	h (cm)	e (mm)	U.Venta
63729	23.76	28	8,5	0,9	1

▶ ACCESORIOS

Protector de silicona

Protection en silicone
Silikonschutz
Silicone handle cover
Protector de silicone



Ref	€	L (cm)	U.Venta
23900	5,50	13,5	1

Mango protector de silicona de alta calidad para sartenes.
Fácil de colocar, se ajusta perfectamente al mango de la sartén.
Antideslizante y termo resistente, protege de las temperaturas elevadas.
Compatible con nuestras sartenes Robust, Ferrum, Dynamic y Tricapa Plus (Ø16-32).

High quality protective silicone handle for frying pans
Easy to put on, it fits the pan handle perfectly.
Non-slip and heat resistant, it protects from high temperatures.
Compatible with our Ferrum, Robust, Dynamic and Tricapa Plus frying pans (Ø16-32)

Se adapta a todo tipo de baterías de cocina.
Vidrio térmico resistente a altas temperaturas.
Borde de acero inoxidable 18/10.

Fits all types of cookware.
Tempered glass resistant to high temperatures.
18/10 stainless steel rim.



Tapa de cristal con desvaporizador

Couvercle en verre avec sortie de vapeur.
Glasdeckel mit Dampfloch
Glass Lid with steam hole
Tampa de vidro con desvaporizador



Ref	€	Ø (cm)	U.Venta
71914	9,03	14	1
71916	9,23	16	1
71918	9,55	18	1
71920	10,27	20	1
71922	10,38	22	1
71924	10,79	24	1
71926	11,93	26	1
71928	12,45	28	1
71932	14,01	32	1



Tapa apta para Ø20 hasta Ø28 cm
Cover suitable for Ø20 up to Ø28 cm

Asa resistente al calor Stay Cool
Stay Cool heat-resistant handle

Acabado antiadherente
y vidrio resistente al calor
Non-stick finish and heat-resistant glass



AL

Aluminium

Tapa aluminio antisalpicaduras Universal

Couvercle en aluminium anti-projections Universal
Universal-Anti Spritzschutz, Aluminium
Universal aluminium anti-spash cover
Tampa alumínio anti respingo Universal

Ref	€	Ø (cm)	U.Venta
71931	14,84	20-28	1

DOMÉSTICO

ECO-PIEDRA BLACK



Fabricadas en aluminio fundido de gran calidad y espesor, están reforzadas con partículas a base de piedra y una máxima resistencia al rayado, duración y desgaste.

La base de aluminio permite una distribución homogénea del calor, permitiendo que los alimentos se cocinen rápidamente y de manera uniforme, sin apenas utilizar aceite.

Su antiadherente TRICAPA de máxima calidad y ecológico, es libre de PFOA. Fácil limpieza interior y exterior gracias al antiadherente.

Son aptas para todo tipo de fuegos y se puede lavar en el lavavajillas. **Parrillas - Planchas:** Asas fabricadas en silicona de máxima calidad, termoaislantes, altamente resistentes y ergonómicas, permiten un agarre seguro en la piza.

Fabricées en fonte d'aluminium de grande qualité et épaisseur, elles sont renforcées par particules à base de pierre et confère une résistance maximale aux rayures et à l'usure pour allonger la durée de vie.

La base en aluminium permet une distribution homogène de la chaleur, permettant aux aliments de se cuire rapidement et de façon uniforme, sans à peine utiliser d'huile. Leur antiadhésif.

Tri-couche d'une qualité maximale et écologique, est sans PFOA. Intérieur et extérieur faciles à nettoyer grâce à la protection antiadhésive. Elles sont compatibles avec tout type de feux et peuvent être lavées au lave vaisselle. **Parrilles - Planchas:** Poignées fabriquées en silicone de la plus grande qualité, thermo-isolantes, hautement résistantes et ergonomiques, qui permettent de tenir l'ustensile en toute sécurité.

Aus besonders dickem und qualitativem Aluminium gegossen und mit Steinbeschichtung mit Steinbeimischung und maximaler Lebensdauer, Kratzfestigkeit und Widerstandsfähigkeit.

Aluminiumgrundlage sorgt für gleichmäßige Wärmeverteilung um Lebensmittel schnell und gleichmäßig und ohne viel Öl zu kochen. Umweltfreundliche und qualitativ.

Antihaftbeschichtung TRICAPA ohne PFOA.

Innen und außen einfach zu reinigen, dank Antihaftbeschichtung.

Für alle Herdarten geeignet und Waschmaschinen tauglich.

Platte - Plate Grill: Hochwertige, ergonomische Silikongriffe mit hoher Temperaturfestigkeit gewährleisten ein sicheres Halten des Geschirrs.

Made in high quality and thickness cast aluminium, it is reinforced with stone-based particles and maximum scratch and wear resistance and durability. The aluminium base allows for a homogeneous heat distribution, allowing the food to cook quickly and uniformly, without barely any oil.

Its high quality and eco-friendly non-stick coating TRICAPA is PFOA-free. Easy to clean interior and exterior with its non-stick protection.

They are suitable for all range cookers and they are dishwasher safe. **Brunt rack - Grill plates:** Heat insulating, highly resistant, ergonomic handles made of high quality silicone which provide a secure grip on pots and pans.

Fabricadas em alumínio fundido de grande qualidade e espessura, reforçadas com partículas a base de pedra, durável e resistente aos riscos e ao desgaste.

A base de alumínio permite uma distribuição homogénea do calor, e uma cocção mais rápida e uniforme dos alimentos, com uma quantidade mínima de óleo.

Revestimento antiaderente TRICAPA de máxima qualidade e ecológico, sem PFOA. Fácil limpeza interior e exterior graças à sua proteção antiaderente.

Aptas para todo o tipo de fogões, e para máquinas de lavar louça.

Parrilhas - Planchas: Asas fabricadas em silicone de grande qualidade, termoisolantes, altamente resistentes e ergonómicas, que permitem agarrar a peça com segurança.



Sartén
Poêle
Pfanne
Frying pan
Sertã



Ref	€	Ø (cm)	h (cm)	e (mm)	U.Venta
24120	26,56	20	5,0	4,0	6
24122	28,32	22	5,5	4,0	6
24124	30,71	24	6,0	4,0	6
24126	34,24	26	6,0	4,0	6
24128	36,42	28	6,0	4,0	6



Wok
Wok
Wok
Wok
Wok



Ref	€	Ø (cm)	h (cm)	e (mm)	U.Venta
24138	36,73	28	9,0	4,0	1



Fondo FULL INDUCTION
FULL INDUCTION bottom

Incluye asas de silicona
Includes silicone handles



Paellera
Plat à paella
Pfanne
Round dish
Paelheira

Ref	€	Ø (cm)	h (cm)	Raciones	e (mm)	U.Venta
25432	54,12	32	4,5	5	1,6	1
25436	58,58	36	4,5	7	2,0	1
25440	79,27	40	4,5	9	2,0	1

Si

Silicone

Asas para paellera ECO-PIEDRA

Poignées pour plat rond
Griffschutz for Pfanne
Handles for round dish
Asas para paelheira



Ref	€	Ø (cm)	U.Venta
R25436A	9,96	32-36-40	1



Grill liso
Grill lisse
Grill glatt
Grill flat
Grêlhador liso



Ref	€	cm	h (cm)	e (mm)	U.Venta
24123	31,64	24x24	4,5	4,0	1
24127	37,97	28x28	4,5	4,0	1



Grill
Grill
Grill
Grill
Grêlhador



Ref	€	cm	h (cm)	e (mm)	U.Venta
24125	31,75	24x24	4,5	4,0	1
24129	38,08	28x28	4,5	4,0	1



Crepera
Crêpière
Crêpes Pfanne
Crêpière
Crepeira



Ref	€	Ø (cm)	h (cm)	e (mm)	U.Venta
24137	27,70	24	1,8	4,0	1
24136	30,71	26	1,8	4,0	1



Incluye asas de silicona
Includes silicone handles

Plancha Grill
Plaque à Grill
Platte Grill
Grill plaque
Plancha Grill



Ref	€	Area cocción (cm)	h (cm)	cm (Total)	e (mm)	U.Venta
25536	31,64	25,5x20	1,5	37,5x23x4,5	4,0	1
25547	43,78	33,5x25	2,0	47,5x29x5,5	4,0	1



Incluye asas de silicona
Includes silicone handles

Plancha Grill
Plaque à Grill
Platte Grill
Grill plaque
Plancha Grill



Ref	€	Area cocción (cm)	h (cm)	cm (Total)	e (mm)	U.Venta
24134	55,51	33x25	2,0	46x27,5x6	4,0	1



Incluye asas de silicona
Includes silicone handles

Plancha Grill lisa
Plaque à Grill lisse
Platte Grill, glatt
Grill flat plaque
Plancha Grill lisa



Ref	€	Area cocción (cm)	h (cm)	cm (Total)	e (mm)	U.Venta
24135	57,69	33x25	2,0	46x27,5x6	4,0	1

Si

Silicone

Asas para plancha Grill GREY

Poignées pour plaque à Grill
Griffschutz for Platte Grill
Handles for grill plaque
Asas para plancha Grill



Ref	€	cm	U.Venta
R25736A	3,42	36	1
R25747A	4,77	47	1

Si

Silicone

Asas para plancha Grill RED

Poignées pour plaque à Grill
Griffschutz for Platte Grill
Handles for grill plaque
Asas para plancha Grill



Ref	€	cm	U.Venta
R25536A	3,42	36	1
R25547A	4,77	47	1

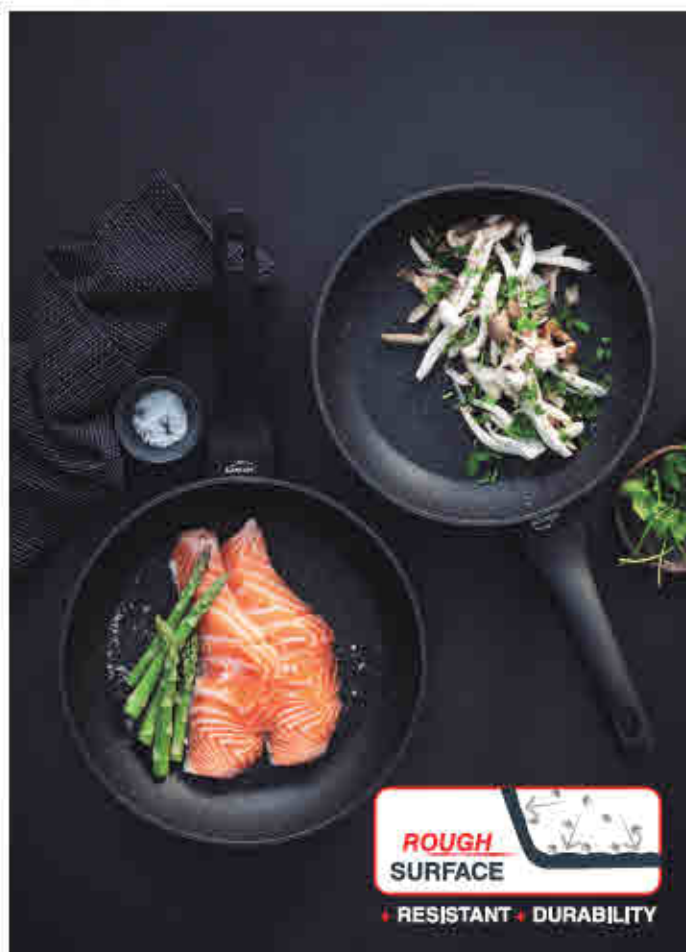

ROUGH SURFACE
RESISTANT + DURABILITY



Fabricada en aluminio forjado de máxima calidad. Antiadherente interior y exterior reforzado a base de partículas de piedra. Ecológico, libre de materiales tóxicos y pesados. Libre de PFOA. Fondo FULL INDUCTION compatible con todas las fuentes de calor, incluida la inducción. Excelente conductividad térmica.

Fabriqué en aluminium forgé de la plus grande qualité. Antiadhérent intérieur et extérieur renforcé à base de particules de pierre. Écologique, exempt de matériaux toxiques et lourds. Sans PFOA. Fond « FULL INDUCTION » compatible avec toutes les sources de chaleur, y compris l'induction. Excellente conductivité thermique.

Aus geschmiedetes Aluminium höchster Qualität. Anti-Haft-Wände innen und außen, verstärkt mit Steinbeimischung. Ökologisch, frei von giftigen und schweren Stoffen. Ohne PFOA. FULL INDUCTION Boden für alle Herdarten geeignet, einschließlich Induktion. Hervorragende Wärmeleitfähigkeit.

Made of high quality forged aluminum. Reinforced non-stick coating inside and outside using stone particles. Ecological, free of toxic and heavy materials. PFOA free. FULL INDUCTION base that can be used with all kinds of heat sources, including induction cookers. Excellent thermal conductivity.

Fabricada em alumínio forjado de máxima qualidade. Revestimento antiadherente interior e exterior reforçado, à base de partículas de pedra. Ecológico, livre de materiais tóxicos e pesados. Livre do PFOA. Fundo "FULL INDUCTION", compatível com todo o tipo de fontes de calor, incluindo placas de indução. Excelente condutividade térmica.

Sartén
Poêle
Pfanne
Frying-pan
Sertã



Ref	€	Ø (cm)	h (cm)	e (mm)	U.Venta
26818	12.24	18	4.0	3.0	5
26820	13.38	20	4.0	3.0	6
26822	15.04	22	4.5	3.0	6
26824	16.39	24	4.5	3.0	6
26826	18.05	26	5.0	3.0	6
26828	19.61	28	5.5	3.0	6
26830	21.89	30	5.5	3.0	6

New

Grill
Grill
Grill Induktionfähig
Grill
Grelhador



Ref	€	cm	h (cm)	e (mm)	U.Venta
26858	22.00	28 x 28	4.5	3.0	1

New

Wok
Wok
Wok
Wok
Wok



Ref	€	Ø (cm)	h (cm)	e (mm)	U.Venta
26848	19.40	28	8.0	3.0	1

New

Sartén honda
Poêle profonde
Tiefe Pfanne
Deep frying-pan
Sertã funda



Ref	€	Ø (cm)	h (cm)	e (mm)	U.Venta
26834	17.43	24	6.5	3.0	1
26838	20.65	28	7.0	3.0	1

New

Crepera
Crêpière
Crêpes Pfanne
Crepiere
Crepeira



Ref	€	Ø (cm)	h (cm)	e (mm)	U.Venta
26844	15.15	24	2.0	3.0	1

TITANIUM PRO

Sartén
Poêle
Pfanne
Frying-pan
Sertã



Ref	€	Ø (cm)	h (cm)	U.Venta
27820	26,66	20	5,0	6
27824	32,89	24	5,5	6
27828	39,94	28	6,0	6



Cuerpo fabricado en aluminio fundido en una sola pieza.
Antiadherente Quantanium. Recubrimiento de máxima calidad reforzada con partículas a base de titanio.

Body made of cast aluminum in one piece construction.
Non-stick Quantanium top quality coating reinforced with titanium based particles.

Compartimentos individuales
Individual compartments

4 in 1

Grill
Grill
Grill Induktionfähig
Grill
Grelhador



Ref	€	cm	h (cm)	U.Venta
27827	46,38	28x28	4,0	1

Sartén 4 cavidades
Poêle 4 cavités
Pfanne 4 Kavitäten
Frying-pan 4 cavities
Sertã 4 cavidades



Ref	€	cm	h (cm)	U.Venta
27832	40,05	32x26	3,5	1



QUANTANIUM

Grill
Grill
Grill Induktionfähig
Grill
Grelhador



Ref	€	cm	h (cm)	U.Venta
25525	33,10	24x24	4,0	1
25529	40,15	28x28	4,0	1



Cuerpo fabricado en aluminio fundido en una sola pieza.
Antiadherente TRICapa Quantanium.

Body made of cast aluminum in one piece construction.
Non-stick TRI-layer Quantanium top quality coating.

FIT

Acero Inoxidable, no se calienta
St steel, heat-resistant



Sartén
Poêle
Pfanne
Frying pan
Sertã

Ref	€	Ø (cm)	h (cm)	L	e (mm)	U.Venta
48720	27,81	20	4,0	0,90	4,5	6
48724	34,76	24	4,5	1,50	4,5	6
48728	41,50	28	5,0	2,70	4,5	6



Capa de óxido natural de protección muy gruesa.
Muy resistentes a arañazos, deformaciones y corrosión.
Distribuye uniformemente el calor, sin áreas de sobrecalentamientos.

Thick natural oxide protective layer.
Very resistant to scratches, deformation and corrosion.
Hot spot free, uniform heat distribution.

STILO

Sartén
Poêle
Pfanne
Frying pan
Sertä



Ref	€	Ø (cm)	h (cm)	U.Venta
27620	29,57	20	4,5	6
27624	33,72	24	5,2	6
27626	37,14	26	5,5	6
27628	40,15	28	6,0	6



Cuerpo fabricado en una sola pieza.
Fabricada en aluminio fundido de gran robustez.
Recubrimiento en piedra hiper resistente a los arañazos.
Revestimiento antiadherente de alta calidad y ecológico, libre de PFOA.
Apta para todo tipo de cocinas, incluida la inducción.

Constitue en une seule pièce
Fabriquée en fonte d'aluminium d'une grande robustesse.
Revêtement en pierre hyper résistant aux rayures
Revêtement antiadhésif de grande qualité et écologique, exempt de PFOA.
Compatible avec tout type de cuisines, y compris l'induction

Aus einem Stück gefertigt.
Aus sehr widerstandsfähigem druckgegossenem Aluminium
Mit kratzfestem Steinüberzug
Mit hochwertiger, ökologischer Antihaftbeschichtung, PFOA frei
Geignet für alle Art von Kochfeldern, inklusive Induktion

Body made in one piece.
Manufactured in highly robust cast aluminium.
Super scratch resistant stone coating.
High quality, ecological, PFOA-free anti-stick coating.
Suitable for all types of kitchens, including those with induction cookers

Elementos fabricados a partir de uma única peça
Fabricada em alumínio fundido de grande robustez
Fabricada em alumínio fundido de grande robustez.
Revestimento antiaderente de alta qualidade e ecológico, sem de PFOA.
Apta para todo o tipo de fogões, incluindo placas de indução

Grill
Grill
Grill Induktionfähig
Grill
Griehador



Ref	€	cm	h (cm)	U.Venta
27625	37,14	24x24	4,8	1
27629	43,06	28x28	5,2	1

LOFT

Sartén LOFT
Poêle
Pfanne
Frying-pan
Sertä



Ref	€	Ø (cm)	h (cm)	e (mm)	U.Venta
24918	16,08	18	3,8	3,5	6
24920	17,64	20	4,3	3,5	6
24922	18,99	22	4,3	3,5	6
24924	21,27	24	4,8	3,5	6
24926	22,72	26	4,8	3,5	6
24928	26,15	28	5,3	3,5	6



Fabricada en aluminio embutido, acabado fuerte y robusto.
Recubrimiento antiadherente. Calidad y larga duración.
Exterior en negro mate.
Calentamiento rápido y uniforme.
Mango SOFT TOUCH.

Fabriquée en aluminium embouti, finition forte et robuste.
Revêtement antiadhésif. Qualité et longue durée de vie.
Extérieur en noir mat.
Chauffe rapide et uniforme.
Manche SOFT TOUCH.

Aus gepresstem Aluminium mit gehärtetem und robustem Finish
Antihaftbeschichtung. Qualität und lange Haltbarkeit.
Mattschwarzes Äußeres
Gleichmäßige und schnelle Erwärmung
SOFT TOUCH-Griff

Made from deep drawn aluminium, strong and robust finish.
Non-stick coating. Quality and long life.
Outside in matte black.
Quick and uniform heating.
SOFT TOUCH handle.

Fabricada em alumínio embutido, com acabamento forte e robusto.
Revestimento antiaderente, de qualidade e longa duração.
Exterior em negro mate.
Aquecimento rápido e uniforme.
Mango SOFT TOUCH

VOGA



Sartén VOGA

Poêle
Pfanne
Frying-pan
Sertã



Ref	€	Ø (cm)	h (cm)	e (mm)	U.Venta
24720	27,70	20	4,5	4,0	6
24722	30,30	22	5,0	4,0	6
24724	33,93	24	5,0	4,0	6
24726	37,56	26	5,5	4,0	6
24728	40,15	28	6,0	4,0	6
24732	46,79	32	6,5	4,0	6



Fabricado en aluminio forjado, acabado fuerte y robusto.

Calentamiento rápido y uniforme.

Recubrimiento antiadherente ILAG:ULTIMATE (Trícapa) de gran calidad ultrarresistente y de uso intensivo.

Mango de acero inoxidable, no se calienta.

Fabriqué en aluminium forgé, finition solide et robuste.

Chauffe rapide et uniforme.

Revêtement antiadhésif ILAG:ULTIMATE (triple-couche) de grande qualité ultra-résistant et à usage intensif.

Manche en acier inoxydable, ne chauffe pas.

Hergestellt aus geschmiedetem Aluminium, starke und robuste Verarbeitung.

Schnelle und gleichmäßige Erwärmung.

Qualitativ hochwertige und widerstandsfähige Antihaltbeschichtung

ILAG-ULTIMATE (dreifach) für hohe Beanspruchung.

Eisenhandgriff wird nicht heiß.

Made of forged aluminium, strong and robust finish.

Quick and even heating.

Ultra-resistant high-quality ILAG-ULTIMATE non-stick coating (Triple layer) for intensive use.

Heat-resistant stainless steel handle.

Fabricado em alumínio forjado, com um acabamento forte e robusto.

Aquecimento rápido e uniforme.

Revestimento antiaderente ILAG:ULTIMATE (Trícapa) de grande qualidade, ultra-resistente a o uso intensivo.

Mango de aço inoxidável, que não aquece.

FOGO



Fondo FULL INDUCTION
FULL INDUCTION bottom



Set 2 sartenes

Set 2 poêles
Set 2 Bratpfannen
Set 2 frying pans
Conjunto 2 sertãs

Ref	€	Ø (cm)	h (cm)	e (mm)	U.Venta
25400	28,84	20	4,2	3,0	1
		24	4,7	3,0	



Fabricada en aluminio forjado de máxima calidad.

Recubrimiento antiadherente reforzado TRICAPA.

Ecológico, libre de materiales tóxicos y pesados, libre de PFOA.

Fondo FULL INDUCTION compatible con todas las fuentes de calor, incluida la inducción.

Excelente conductividad térmica.

Fabriqué en aluminium forgé de la plus grande qualité.

Revêtement antiadhésif renforcé TRICAPA.

Écologique, exempt de matériaux toxiques et lourds. Sans PFOA.

Fond - FULL INDUCTION - compatible avec toutes les sources de chaleur, y compris l'induction.

Excellente conductivité thermique.

Aus geschmiedetes Aluminium höchster Qualität.

Mit verstärkter Antihaltbeschichtung, beste Qualität TRICAPA.

Ökologisch, frei von giftigen und schweren Stoffen. Ohne PFOA.

FULL INDUCTION-Boden für alle Herdarten geeignet, einschließlich Induktion. Hervorragende Wärmeleitfähigkeit.

Made of high quality forged aluminium.

Reinforced non-stick TRICAPA coating.

Ecological, free of toxic and heavy materials. PFOA-free.

FULL INDUCTION base that can be used with all kinds of heat sources, including induction cookers.

Excellent thermal conductivity.

Fabricada em alumínio forjado da máxima qualidade.

Revestimento antiaderente reforçado TRICAPA.

Ecológico, livre de materiais tóxicos e pesados. Livre de PFOA.

Fundo "FULL INDUCTION", compatível com todo o tipo de fontes de calor, incluindo placas de indução.

Excelente condutividade térmica.

New

SARTENES GARINOX Y VITE



Rápida y eficaz · Fast and efficient



Fabricadas en aluminio de máxima calidad.
Recubrimiento antiadherente bicapa reforzado, resistente a arañazos y ralladuras. Libre de PFOA.
Compatible con todas las fuentes de calor, incluida la inducción.
Excelente conductividad térmica.

Fabricoée en aluminium de la plus grande qualité.
Revêtement antiadhésif bi-couche renforcé, résistant aux rayures.
Sans PFOA.
Compatible avec toutes les sources de chaleur, y compris l'induction.
Excellent conductivité thermique.

Aus Aluminium höchster Qualität.
Verstärkte Antifaltbeschichtung, abrieb- und kratzfest (welllagig). Ohne PFOA.
Boden für alle Herdarten geeignet, einschließlich Induktion.
Hervorragende Wärmeleitfähigkeit.

Made of high quality aluminum.
Scratch and scrape resistant reinforced bilayer non-stick coating.
PFOA Free.
Can be used with all kinds of heat sources, including induction cookers.
Excellent thermal conductivity.

Fabricada em alumínio da máxima qualidade.
Revestimento antiaderente bicapa reforçada, resistente a riscos e ao atrito.
Não contém PFOA.
Compatível com todo o tipo de fontes de calor, incluindo placas de indução.
Excelente condutividade térmica.



New



Sartén GARINOX

Poêle
Pfanne
Frying-pan
Sertã



Ref	€	Ø (cm)	h (cm)	e (mm)	U.Venta
26418	9,34	18	4,0	3,0	1
26420	10,48	20	4,0	3,0	1
26422	11,93	22	4,5	3,0	1
26424	13,18	24	4,5	3,0	1
26426	15,04	26	5,0	3,0	1
26428	16,60	28	5,0	3,0	1
26430	18,06	30	5,5	3,0	1

Sartén VITE

Poêle
Pfanne
Frying-pan
Sertã



Ref	€	Ø (cm)	h (cm)	e (mm)	U.Venta
26718	10,79	18	4,0	3,0	6
26720	12,14	20	4,0	3,0	6
26722	13,80	22	4,5	3,0	6
26724	15,15	24	4,5	3,0	6
26726	17,22	26	5,0	3,0	6
26728	19,09	28	5,0	3,0	6
26730	20,65	30	5,5	3,0	6

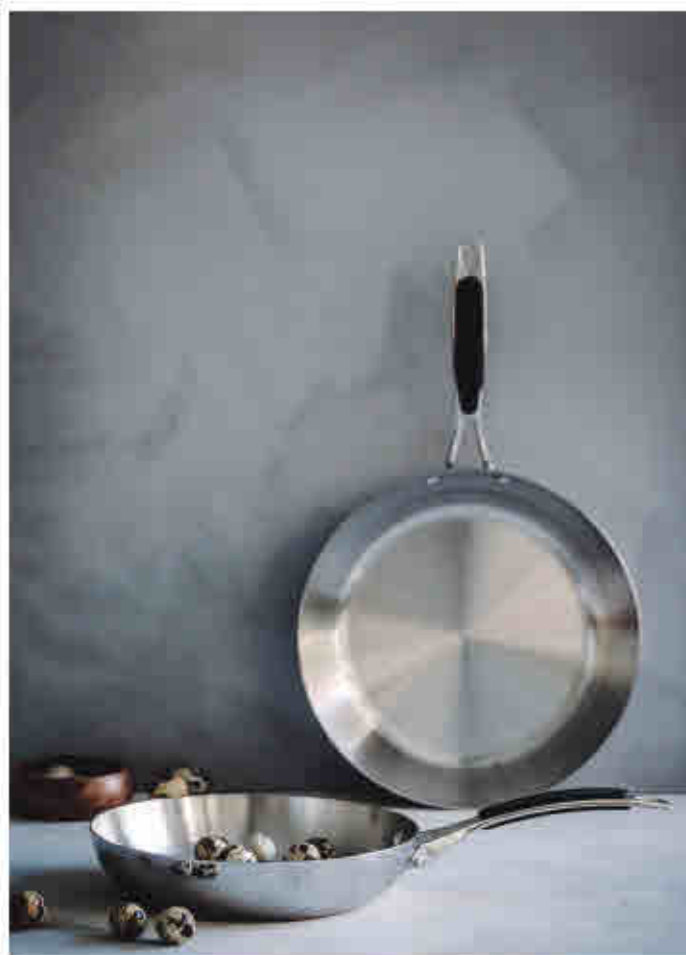

Cuerpo fabricado en 3 capas: acero inoxidable 18/10, aluminio, acero inoxidable 18%. La capa exterior, es de acero inoxidable con componentes ferríticos, lo que la convierte totalmente compatible con las cocinas de inducción. Los mangos están fabricados en acero inoxidable 18/10 y recubiertos con un protector térmico de silicona para facilitar un agarre perfecto y seguro.

Corps fabriqué avec 3 couches : acier inoxydable 18/10, aluminium, acier inoxydable 18%. La couche extérieure est en acier inoxydable avec des composants ferritiques, ce qui lui permet d'être totalement compatible avec les cuisinières à induction. Les manches sont fabriqués en acier inoxydable 18/10 et recouverts d'une protection thermique en silicone pour faciliter une prise en main parfaite et sûre.

Kessel aus preisligem Material: rostfreier Stahl 18/10, Aluminium, rostfreier Stahl 18%. Induktionstauglich dank Außenschicht aus rostfreiem Stahl mit ferritischem Bestandteilen. Die Griffe und Stiele aus rostfreiem Stahl 18/10 und mit wärmeabweisender Silikonummantelung geben sicheren und perfekten Halt.

Body manufactured in a 3 layered: 18/10 stainless steel, aluminium, 18% stainless steel. Exterior layer of stainless steel with ferrite materials, making it completely compatible with induction cookers. The grips are made in 18/10 stainless steel and covered in a silicon heat protection for easy and safe gripping.

Corpo fabricado em 3 camadas: aço inoxidável 18/10, alumínio, aço inoxidável 18%. Camada exterior de aço inoxidável com componentes ferríticos, totalmente compatível com as placas de indução. Mangos fabricados em aço inoxidável 18/10, revestidos com um protetor térmico de silicone para uma sujeição perfeita e segura.



Sartén
Poêle
Pfanne
Frying pan
Sertã



Ref	€	Ø (cm)	h (cm)	e (mm)	U.Venta
53720	48,76	20	4,5	2,3	1
53724	54,37	24	5,0	2,3	1
53728	66,61	28	5,5	2,3	1



Sartén antiadherente
Poêle antiadhérent
Pfanne, Antihalt
Non-stick frying pan
Sertã anti-aderente



Ref	€	Ø (cm)	h (cm)	e (mm)	U.Venta
53721	57,37	20	4,5	2,3	1
53725	68,68	24	5,0	2,3	1
53729	86,74	28	5,5	2,3	1

Wok
Wok
Wok
Wok
Wok



Ref	€	Ø (cm)	h (cm)	e (mm)	U.Venta
53828	72,42	28	8,0	2,3	1



Wok antiadherente
Wok, Antiadhérent
Wok, Antihalt
Wok, non-stick
Wok anti-aderente



Ref	€	Ø (cm)	h (cm)	e (mm)	U.Venta
53829	82,27	28	8,0	2,3	1

▶INOX 18/10

Sartén FOODIE

Poêle
Pfanne
Frying pan
Sertã



Ref	€	Ø (cm)	h (cm)	e (mm)	U.Venta
45420	26,56	20	5,5	0,6	1
45424	31,75	24	6,0	0,6	1
45428	37,25	28	6,5	0,6	1



Antidherente QuanTanium® reforzado con partículas de titanio
QuanTanium® non-stick reinforced with titanium particles

Sartén antiadherente FOODIE

Poêle antiadherent
Eisen-Pfanne, Antihalt
Frying-pan, non-stick
Sertã anti-aderente



Ref	€	Ø (cm)	h (cm)	e (mm)	U.Venta
45320	31,23	20	5,5	0,6	1
45324	38,18	24	6,0	0,6	1
45328	45,75	28	6,5	0,6	1

Sartén VITROCOR

Poêle
Pfanne
Frying pan
Sertã



Ref	€	Ø (cm)	h (cm)	e (mm)	U.Venta
40619	28,01	18	4,5	0,7	1
40621	29,78	20	4,5	0,7	1
40623	30,92	22	5,0	0,7	1
40625	33,10	24	5,2	0,7	1
40627	34,03	26	6,0	0,7	1
40629	36,62	28	6,5	0,7	1

Crepiera MILAN

Crêpière
Crêpes Pfanne
Crepiera
Crepiera



Ref	€	Ø (cm)	h (cm)	e (mm)	U.Venta
71726	47,10	26	2,0	0,7	1



Fabricadas en acero inoxidable 18/10 de la mejor calidad.
Máxima garantía en resistencia, durabilidad e higiene.
Acabado interior y exterior lijado satinado.
Fondo termodifusor sandwich, distribución rápida y uniforme del calor.
Homogeneidad y eficacia térmica. Cocción ultra-rápida.
Aptas para todos los fuegos.

Fabricadas em aço inoxidável 18/10 de lá melhor qualidade.
Garantia máxima de resistência, de durabilidade e d'hygiène.
Finição interna e externa em branhagem satinada.
Fundo termo-difusor sandwich, distribuição rápida e uniforme de la chaleur.
Homogeneidade e eficacia térmica. Cuisson ultra-rápida.
Après pour tous les feux.

Aus Edelstahl 18/10 besser Qualität.
Garantiert robust, langlebig und hygienisch.
Außen- und Innenseite in mattem Schweiß.
Wärmediffusor Sandwichboden, schnelle und gleichmäßige Wärmeverteilung.
Gleichförmigkeit und thermische Effektivität. Ultra-schnelles Garen.
Für alle Herdarten geeignet.

Maximum guarantee in resistance, durability and hygiene.
Glossy sanded interior and exterior finish.
Heat-diffusing sandwiched base, quick and even heat distribution.
Thermal homogeneity and efficiency. Ultra-rapid cooking.
Suitable for all types of cookers.

Fabricadas em aço inoxidável 18/10 de melhor qualidade.
Máxima garantia de resistência, durabilidade e higiene.
Acabamento interior e exterior acatinado.
Fundo termodifusor tipo sanduiche, que assegura uma distribuição rápida e uniforme do calor.
Homogeneidade e eficacia térmica. Coccão ultra-rápida.
Aptas para todos os fogões.



Antiadherente - Non-stick ECLIPSE PLUS

Sartén lisa HOME

Poêle, lisse
Pfanne, glatt
Frying-pan flat
Sertã



Ref	€	Ø (cm)	h (cm)	e (mm)	U.Venta
71318	32,27	18	5,5	0,7	1
71320	33,93	20	5,5	0,7	1
71322	37,77	22	5,5	0,7	1
71324	41,29	24	6,0	0,7	1
71326	45,34	26	6,0	0,7	1
71328	50,94	28	6,5	0,7	1



Antiadherente - Non-stick ECLIPSE PLUS

Sartén HOME

Poêle
Pfanne
Frying-pan
Sertã

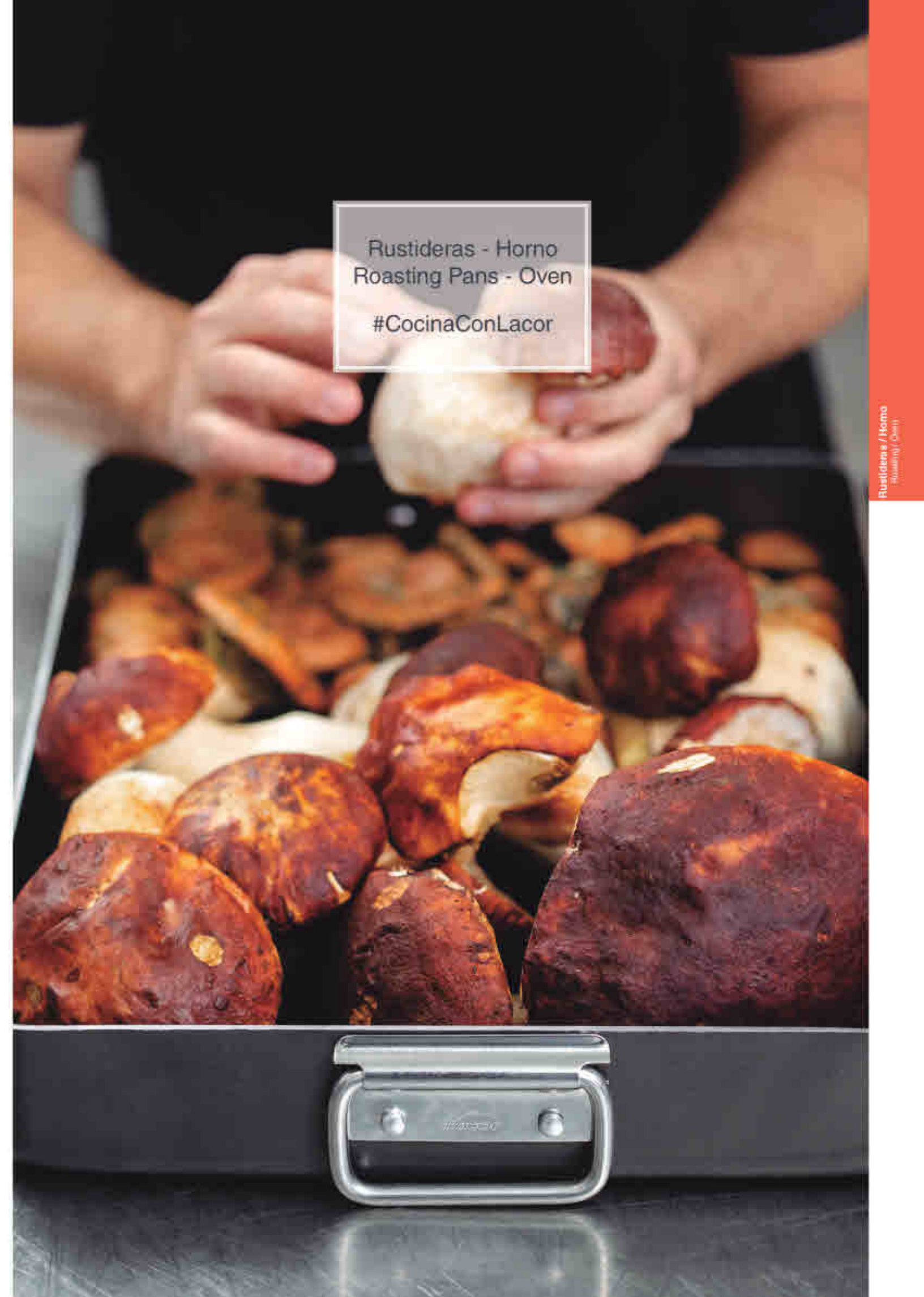

Ref	€	Ø (cm)	h (cm)	e (mm)	U.Venta
71818	32,27	18	5,5	0,7	1
71820	33,93	20	5,5	0,7	1
71822	37,77	22	5,5	0,7	1
71824	41,29	24	6,0	0,7	1
71826	45,34	26	6,0	0,7	1
71828	50,94	28	6,5	0,7	1

A close-up photograph of a person's hands peeling a potato. The person is wearing a black t-shirt. Below their hands is a black roasting pan filled with roasted potatoes, some whole and some cut into wedges. The pan has a silver metal handle with a latch. The background is a stainless steel countertop.

Rustideras - Horno
Roasting Pans - Oven

#CocinaConLacor

RUSTIDERAS



Inox
18/10



Oven



Roaster

Gran calidad, resistencia, tamaño y capacidad, muy útiles en la cocina. Ideales para la cocción de platos y asados al horno.

Soportan sin problemas temperaturas altas.

Excelente resistencia a la corrosión y a los ácidos alimentarios y sales. Asas atórmicas.

Grande qualità, robustesse, taille et capacité, très utiles dans la cuisine

Idéal pour la cuisson de plats et de rôis au four

Supporte sans problèmes des températures élevées

Excellente résistance à la corrosion et aux sels et acides alimentaires

Poignées athermiques

Qualität, Widerstandsfähigkeit, Größe und Fassungsvermögen auf hohem Niveau

Ein sehr praktischer Küchenhelfer

Ideal für Gerichte und Braten aus dem Ofen

Hält hohen Temperaturen problemlos stand

Sehr korrosionsbeständig und widerstandsfähig gegen Säure aus Lebensmitteln und Salzen

Hitzeabweisende Griffe

Great quality, durability, size and capacity, very useful in the kitchen

ideal for cooking dishes and roasts in the oven

Easily withstands high temperatures

Excellent resistance to corrosion and to food-acids and salts

Heat-resistant handles

Ótima qualidade e resistência, grande tamanho e capacidade, muito útil na cozinha

Ídeais para a elaboração de pratos e de assados no forno

Soportam temperaturas elevadas sem problemas

Excelente resistência à corrosão e aos ácidos e sais alimentares

Asas atórmicas



Rustidera

Plat à rotir
Lasagneform
Roaster
Assadeira

Ref	€	cm	h (cm)	U.Venta
62530	28.22	30x21	5,5	1
62535	37.25	35x26	5,5	1
62540	47.41	40x31	6,0	1



Rustidera

Plat à rotir
Bratpfanne
Roaster
Assadeira

Ref	€	cm	h (cm)	U.Venta
50540	98.15	40x30	8,0	1
50550	130.00	50x40	8,0	1
50560	163.72	60x45	8,0	1
50570	187.17	70x45	9,5	1



Rustidera Honda asa abatible

Plat à rotir anse tombante
Bratpfanne mit Fallgriffen
Roaster moving handles
Assadeira funda asa abatível

Ref	€	cm	h (cm)	U.Venta
62530A	30.92	30x22	7,5	1
62535A	37.66	35x26	7,8	1
62540A	44.82	40x28	8,0	1
62545A	51.98	45x32	9,0	1

Inox



Rustidera asa abatible

Plat à gratin anse tombante
Bratpfanne mit Fallgriffen
Roaster moving handles
Assadeira asa abatível

Ref	€	cm	h (cm)	U.Venta
61530	13.38	30x22	5,0	1
61535	17.02	35x26	5,3	1
61540	21.58	40x28	5,6	1
61545	31.96	45x32	7,5	1
61550	59.45	50x36	8,5	1

Aluminio puro (99,5%)
Made in pure (99.5%) aluminium



Rustidera con asa abatible
Plat à rôtir anse tombante
Bratpfanne mit Fallgriffen
Roaster moving handle
Assadeira com asa abatível

Ref	€	cm	h (cm)	e (mm)	L	U.Venta
20540A	45,03	40x30	6,2	2,5	7,45	1
20545A	48,35	45x32	6,2	2,5	10,40	1
20550A	60,69	50x35	7,0	3,0	12,60	1
20555A	65,88	55x37	7,7	3,0	16,30	1
20560A	70,86	60x40	7,7	3,0	18,95	1
20565A	79,27	65x43	7,9	3,0	24,30	1
20570A	83,83	70x45	9,0	3,0	28,65	1

Cuerpo fabricado en Aluminio.
Asas y mangos atórmicos en tubo de acero inoxidable 18/10.
Ideales para la cocción de platos y asados al horno.
Apta para todos los tipos de cocina (excepto inducción).
Máxima garantía en cuanto a resistencia, durabilidad e higiene.

Corps fabriqué en aluminium.
Poignées et manches athermiques en tube d'acier inoxydable 18/10
Idéal pour la cuisson de plats et de rôsis au four
Compatible avec tous les types de cuisinières (excepté l'induction).
Garantie maximale en termes de résistance, de durabilité et d'hygiène.

Kessel aus reinem Aluminium
Griffe und Stiele aus hitzeabweisendem Edelsstahl 18/10
Ideal für Gerichte und Braten aus dem Ofen
Für alle Herdarten geeignet (außer Induktion).
Garantiert robust, langlebig und hygienisch

Body made in aluminium.
Heatproof handles and grips in a 18/10 stainless steel tube
Ideal for cooking dishes and roasts in the oven.
Suitable for all types of cooking surfaces (except induction).
Maximum guarantee in terms of resistance, durability and hygiene.

Corpo fabricado em alumínio.
Asas e mangos térmicos em tubo de aço inoxidável 18/10
Ideais para a elaboração de pratos e de assados no forno.
Apta para todos os tipos de fogões (exceto placas de indução).
Máxima garantia de resistência, durabilidade e higiene.

Aluminio puro (99,5%)
Made in pure (99.5%) aluminium



Rustidera con asa fija
Plat à rôtir anse fixe
Bratpfanne m. feststehenden Griffen
Roaster fix handle
Assadeira com asa fixa

Ref	€	cm	h (cm)	e (mm)	L	U.Venta
20540F	45,03	40x30	6,2	2,5	7,45	1
20545F	48,35	45x32	6,2	2,5	10,40	1
20550F	60,69	50x35	7,0	3,0	12,60	1
20555F	65,88	55x37	7,7	3,0	16,30	1
20560F	71,28	60x40	7,7	3,0	18,95	1
20565F	79,27	65x43	7,9	3,0	24,30	1
20570F	83,83	70x45	9,0	3,0	28,65	1



Rustidera Robust c/asa abatible antiadherente
Plat à rôtir Robust anse tombante, antiadherent
Bratpfanne Robust mit Fallgriffen, Aluminium, Antihalt
Roaster Robust moving handle, non-stick
Assadeira Robust com asa abatível anti-aderente

Ref	€	cm	h (cm)	U.Venta
23540A	52,50	40x30	6,2	1
23550A	63,91	50x35	7,0	1



Rustidera aluminio fundido antiadherente
Plat à gratin en aluminium fondu, antiadherent
Bratpfanne, Aluminium, Antihalt
Aluminium cast roaster, non-stick
Assadeira aluminio fundido anti-aderente

Ref	€	cm	h (cm)	U.Venta
25534	51,98	34x28	8	1

Tapa de cristal rustidera
Couvercle en verre pour plat à rôtir
Deckel Glas für Bratpfanne
Lid glass for roaster
Tampa de vidro para assadeira

Ref	€	cm	h (cm)	U.Venta
25539	12,55	34x28	8	1

▶ PLACAS HORNO



Inox

Parrilla

Grille
Gitter, Rost
Grate
Grelha



Ref	€	cm	h (cm)	U.Venta
68741	25,63	60x40	0,8	1

Inox

Parrilla

Grille
Gitter, Rost
Grate
Grelha



Ref	€	cm	Cubeta	U.Venta
66920	45,07	65X53	2/1	1
66921	17,64	53X32,5	1/1	1

AL

Aluminium

Placa horno aluminio antiadherente

Plaque à four aluminium anti-adhésif teflon
Backblech, Aluminium, Teflon
Teflon non-stick coated oven aluminium tray
Placa forno aluminio anti-aderente

Ref	€	cm	h (cm)	U.Venta
68660	30,81	60x40	1,0	1
68659	28,53	GN 1/1	1,0	1



Fe

Iron

Placa Horno acero negro

Plaque à four tôle noire
Backblech, Schwarzstahl
Baking sheet black steel
Placa de forno aço negro

Ref	€	cm	h (cm)	U.Venta
68640	31,23	60x40	0,8	1



Inox

Placa Horno

Plaque à four
Backblech
Baking sheet
Placa de forno

Ref	€	cm	h (cm)	U.Venta
68740	37,66	60x40	0,8	1
68739	29,15	GN 1/1	0,8	1



AL

Aluminium

Placa Horno

Plaque à four
Backblech
Baking sheet
Placa de forno

Ref	€	cm	h (cm)	U.Venta
68641	29,57	60x40	0,8	1
68642	23,86	GN 1/1	0,8	1



▶ PINZAS HORNO

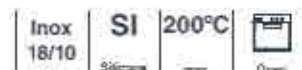

Pinza para horno y bandeja GN

Pince inox pour bac Gastronom
Zange für GN Behälter
Tong GN tray
Pinça para forno e bandejas GN

Ref	€	L (cm)	U.Venta
A 62989	14,63	20	12
B 62998	14,63	20	12

Con silicona / With silicone



TAPETES



Para bridar, albardar, atar asados y rellenos.

Pour ficeler, barder, attacher les rôties et les aliments farcis.
Zum Binden, Umwickeln und Verschüren von Bräun und Füllungen.

For tying, wrapping and trussing roasts and stuffing.
Para embidar, envolver e atar assados e recheios.



Cordel cocina

Fil de cuisine
Küchenschnur
Kitchen string
Fio de cozinha

Ref	€	m	U.Venta
61414	5,08	80	6

Material: Rayón
Rayonne - Kunstseide - Rayon - Raiom

Incluye - Includes:

- 1.- Tablas de conversión de temperatura (°C / °F)
- 2.- Peso (gr / oz)
- 3.- Volumen (ml / fl oz / pt)
- 4.- Longitud (mm / inch)
- 5.- Reglas laterales (cm / inch)

Flexible, antiadherente y reutilizable
Flexible, non-stick and reusable



280°C
max

Tapete de silicona impreso

Tapis en silicone imprimé
Bedruckte Silikonmatte
Printed silicon mat
Tapete de silicone impreso

Ref	€	cm	U.Venta
66759	24,59	60x40	1

Flexible, antiadherente y reutilizable
Flexible, non-stick and reusable

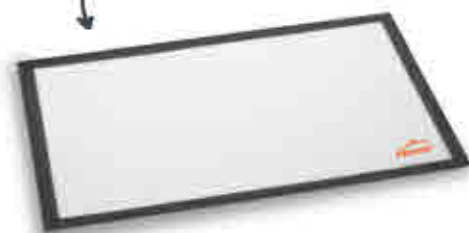

230°C
max

Tapete de silicona

Tapis en silicone
Backblech-Auflage Silikon
Silicone covering
Tapete de silicone

Ref	€	cm	U.Venta
66749	17,95	30x40	1
66731	24,90	60x40	1
66732	18,47	52x32 GN 1/1	1

Permite hornear sin necesidad de utilizar papel de horno.
Lets you bake without having to use oven paper

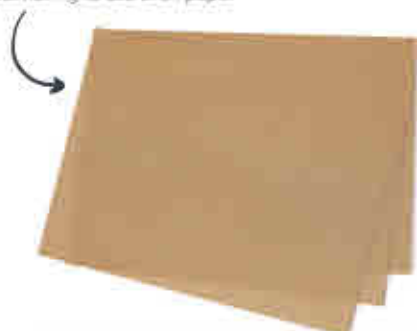

Láminas antiadherentes

Feuilles antiadhésif
Antihalt-Blätter
Non-stick sheets
Láminas antiaderentes

Ref	€	cm	unidades	U.Venta
66746	8,09	30x40	3	1



Láminas de fibra de vidrio con recubrimiento antiadherente de gran calidad.
Ideal para colocar sobre bandejas o parrillas de hornos y deshidratadores.

Vida útil aproximadamente de 1000 hornados.

Diseñadas para soportar temperaturas de hasta 250°C.

Recortable para adaptar a cualquier recipiente.

Reutilizables, para una correcta conservación se recomienda su lavado a mano.

No aptas para lavavajillas.

Fibreglass sheets with non-stick coating high quality.
Ideal for placing on baking trays, oven racks and dehydrators.
Can be used approximately 1,000 times.

Designed to withstand temperatures up to 250°C.

Can be cut to fit any container

Reusable: in order to keep the sheets in good condition, we recommend washing by hand.

Non-dishwasher safe

▶ GUANTES · MANOPLAS



Materiales de alta calidad y una alta protección contra el calor.
Manga que cubre la mayor parte del antebrazo.
Seguro y cómodo en el manejo de objetos calientes.

Matériaux de grande qualité et une haute protection contre la chaleur.
 Manchette qui couvre la plus grande partie de l'avant-bras.
 sûr et pratique pour la manipulation d'objets chauds.

Hohe Materialqualität und Hitzeschutz.
 Beidhändiger Handschuh.
 Ärmel der fast den gesamten Unterarm bedeckt.
 Heiße Gegenstände sicher und bequem handhaben.

High quality materials and excellent heat protection.
 Sleeve that covers most of the forearm.
 Safe and comfortable when handling hot objects.

Materiais de alta qualidade, que proporcionam uma boa proteção contra o calor.
 Manga que cobre a maior parte do antebraço.
 Confortável e segura para a manipulação de objetos quentes.



2
unidades



Guante Universal algodón + silicona

Gant Universal en cotton + silicone
 Universal-Küchenhandschuch, Silikon + Baumwolle
 Cotton + silicone Universal glove
 Luva Universal de algodão + silicone

Ref	€	cm	U.Venta
60062	29,35	32	1



2
unidades



Guante Universal XL algodón + silicona

Gant Universal XL en cotton + silicone
 Universal XL-Küchenhandschuch, Silikon + Baumwolle
 Cotton + silicone Universal XL glove
 Luva Universal XL de algodão + silicone

Ref	€	cm	U.Venta
60068	32,99	48	1

Guante cocina textil + silicona

Gant de cuisine en cotton + silicone
 Küchenhandschuch aus Baumwolle + Silikon
 Gray kitchen cotton + silicone
 Luva de cozinha de algodão + silicone

Ref	€	cm	U.Venta
61034	8,72	32	6



Guante cocina algodón + silicona

Gant de cuisine silicone
 Küchenhandschuh, Silikon + Baumwolle, grau
 Gray kitchen silicone + cotton glove
 Luva de cozinha de algodão + silicone

Ref	€	cm	U.Venta
61033	19,19	35	1



Guante algodón aluminizado

Gant de cuisine coton aluminisé
Küchenhandschuh, Baumwolle, Aluminisierte
Aluminized cotton oven glove
Luva de cozinha de algodão alumínio

Ref	€	cm	U.Venta
61024	4,46	24	1
61030	5,29	30	1
61036	5,71	36	1



Propiedades autoextinguibles

Propriétés arrêt automatiques
Selbstlöschend Eigenschaften
Self-extinguishing properties
Propiedades auto-extinguible

Guante de cocina retardante llama

Gant de cuisine retardateurs de feu
Feuerhemmende Küchenhandschuh
Fire retardant kitchen glove
Luva de cozinha retardante de fogo

Ref	€	cm	U.Venta
60070	10,58	36	1



Guante silicona Roja

Gant de cuisine rouge silicone
Küchenhandschuh aus Silikon
Red silicon oven glove
Luva silicone vermelho

Ref	€	cm	U.Venta
60017	24,90	29	1



Guante silicona 5 dedos

Gant en silicone 5 doigts
Silikon Handschuh 5 fingers
5 fingers silicone gloove
Luva silicone 5 dedos

Ref	€	cm	U.Venta
60034	8,51	27	1



ORKA

Ambidestros, cómodos y ligeros.
Fácil de lavar y desinfectar.

Ambidextres, pratiques et légers.
Facile à laver et désinfecter.

Beidhändig verwendbar, bequem
und leicht.
Leicht zu reinigen und zu desinfizieren

Ambidexous, comfortable and light.
Easy to wash and disinfect.

Ambidestro, cómodos e leves.
Fácil de lavar e desinfectar.

Guante silicona Profesional

Gant de cuisine silicone
Küchenhandschuh, Silikon
Silicone oven glove
Luva silicone

Ref	€	cm	U.Venta
60010	31,95	29	1
60011	52,29	42	1



Manopla de silicona

Mouflette en silicone
Fäustling aus Silikon
Silicone mitten
Pegas de silicone

Ref	€	U.Venta
60014	8,51	6



2

Unidad

Manoplas cobre asas

Mouflette.
Griffschutz.
Mitten
Pegas cobre-asas

Ref	€	U.Venta
60052	8,20	1



Manoplas GRIS

Mouflettes
Fäustling
Mitten
Pegas

Ref	€	Ø (cm)	U.Venta
R25917G	7,16	16	6
R25921G	6,74	20-24-28	6
R25933G	7,16	26x20	6
R25935G	6,74	31x25	6



Asas para paellera ECO-PIEDRA

Poignées pour plat rond
Griffschutz für Platte
Handles for round dish
Asas para paellera

Ref	€	Ø (cm)	U.Venta
R25436A	9,96	32-36-40	1





Asas batería TITANIUM

Poignées
Griffschutz, Silikon
Handles
Asas

Ref	€	Ø (cm)	U.Venta
R27520A	3,74	20	1
R27528A	3,84	24-28	1
R27732A	4,77	32-36	1



Asas para plancha Grill RED

Poignées pour plaque à Grill
Griffschutz für Platte Grill
Handles for grill plaque
Asas para plancha Grill

Ref	€	cm	U.Venta
R25536A	3,42	36	1
R25547A	4,77	47	1



Asas para plancha Grill GREY

Poignées pour plaque à Grill
Griffschutz für Platte Grill
Handles for grill plaque
Asas para plancha Grill

Ref	€	cm	U.Venta
R25736A	3,42	36	1
R25747A	4,77	47	1



Protector de silicona

Protection en silicone
Silikonschutz
Silicone handle cover
Protector de silicone

Ref	€	L (cm)	U.Venta
23900	5,50	13,5	1

Mango protector de silicona de alta calidad para sartenes.

Fácil de colocar, se ajusta perfectamente al mango de la sartén.

Antideslizante y termo resistente, protege de las temperaturas elevadas.

Compatible con nuestras sartenes Robust, Ferrum, Dynamic y Tricapa Plus (Ø16-32).

Manche de protection en silicone de grande qualité pour poêles.

Facile à installer, il s'adapte parfaitement au manche de la poêle.

Antidérapant et thermorésistant, il protège des températures élevées.

Compatible avec nos poêles Ferrum, Robust, Dynamic et Tricapa Plus (Ø16-32).

High quality protective silicone handle for frying pans.

Easy to put on, it fits the pan handle perfectly.

Non-slip and heat-resistant, it protects from high temperatures.

Compatible with our Ferrum, Robust, Dynamic and Tricapa Plus frying pans (Ø16-32).

▶ RELOJES



Reloj de cocina magnético

Minuteur de cuisine magnétique
Magnetküchentimer
Magnetic kitchen timer
Relógio de cozinha magnético

Ref	€	Tiempo	cm	U.Venta
60803	9,23	60 min	9,2x3,5	1



Gracias a su parte posterior magnética podrá colocar el reloj de cocina en cualquier parte metálica de su cocina. Alarma acústica programable.

Grâce à sa partie arrière magnétique, le minuteur peut être placé sur n'importe quelle partie métallique de la cuisine. Alarme acoustique programmable.

Dank der magnetischen Rückseite kann die Küchenuhr an jede metallische Oberfläche in Ihrer Küche angebracht werden. Programmierbarer akustischer Alarm.

Thanks to the magnet on the back, the kitchen timer can be placed on any metal surface in the kitchen. Programmable acoustics alarm.

Grças à sua parte posterior magnética, poderá colocar o relógio de cozinha em qualquer parte metálica da sua cozinha. Alarma sonora programável.

Resistente al agua
Water resistance



12 | IP65 | 99:99:99

Reloj de cocina con alarma

Minuteur de Cuisine avec Alarme
Küchen Zeitschaltuhr mit Alarm
Kitchen Timer Alarm
Relógio de cozinha com alarme

Ref	€	cm	U.Venta
60804	33,41	13x24,5x2,5	1



Reloj Digital de cocina con avisador acústico

Minuter Electronique
Digitale Küchen-Zeitschaltuhr mit Alarm
Digital kitchen timer w/ alarm
Relógio digital de cozinha com alarme acústico

Ref	€	cm	U.Venta
60805	7,78	10,5x7	1

Paelleras
Paella Pans

#CocinaConLacor



▶ INOXIDABLE



Paellera con tapa CHEF-LUXE

Plat rond avec couvercle
Pfanne mit Deckel
Round dish with lid
Paelheira com tampa

Ref	€	Ø (cm)	h (cm)	e (mm)	L	U.Venta
54636	143,07	36	7,0	1,5	7,00	1
54640	174,09	40	8,0	1,5	10,00	1
54645	201,59	45	8,5	2,0	12,00	1
* 54650	254,40	50	9,0	2,0	17,00	1

* NO inducción · NOT induction

Paellera sin tapa CHEF-LUXE

Plat rond s/couvercle
Pfanne ohne Deckel
Round dish without lid
Paelheira sem tampa

Ref	€	Ø (cm)	U.Venta
54636S	113,19	36	1
54640S	140,37	40	1
54645S	162,89	45	1
* 54650S	208,23	50	1

* NO inducción · NOT induction



Paellera con tapa CHEF-CLASSIC

Plat rond a/couvercle
Pfanne mit Deckel
Round with lid
Paelheira com tampa

Ref	€	Ø (cm)	h (cm)	e (mm)	L	U.Venta
50624	53,33	24	6,0	0,8	2,70	1
50628	72,52	28	6,0	0,8	3,60	1
50632	93,89	32	6,0	0,8	5,00	1
50636	118,69	36	7,0	1,0	7,10	1
50640	136,85	40	8,0	1,0	10,00	1
50645	160,61	45	8,5	1,0	13,50	1
50650	208,43	50	9,0	1,0	17,60	1
* 50660	301,39	60	9,0	1,0	25,40	1

* NO inducción · NOT induction

Paellera sin tapa CHEF-CLASSIC

Plat rond s/couvercle
Pfanne ohne Deckel
Round dish without lid
Paelheira sem tampa

Ref	€	Ø (cm)	U.Venta
50624S	40,77	24	1
50628S	58,20	28	1
50632S	74,80	32	1
50636S	95,87	36	1
50640S	110,91	40	1
50645S	129,69	45	1
50650S	170,46	50	1
* 50660S	251,80	60	1

* NO inducción · NOT induction



Paellera sin tapa ECO-CHEF

Plat rond sans couvercle
Pfanne ohne Deckel
Round without lid
Paelheira sem tampa

Ref	€	Ø (cm)	h (cm)	e (mm)	L	U.Venta
57624	34,45	24	6,5	0,8	3,00	1
57628	47,83	28	6,5	0,8	4,00	1
57632	61,01	32	7,0	0,8	5,00	1
57636	78,33	36	7,0	1,0	7,10	1
57640	90,26	40	8,0	1,0	10,00	1

Paellera sin tapa WAGNER

Plat rond s/couvercle
Pfanne ohne Deckel
Round dish without lid
Paelheira sem tampa

Ref	€	Ø (cm)	h (cm)	e (mm)	L	U.Venta
50624W	43,26	24	6,0	0,8	2,70	1
50628W	57,27	28	6,0	0,8	3,60	1
50632W	71,07	32	6,0	0,8	5,00	1
50636W	96,70	36	7,0	1,0	7,10	1
50640W	110,60	40	8,0	1,0	10,00	1
50645W	127,41	45	8,5	1,0	13,50	1
50650W	172,33	50	9,0	1,0	17,60	1
* 50660W	245,37	60	9,0	1,0	25,40	1

* NO inducción · NOT induction





Antiadherente
Non-stick



Paellera Valenciana antiadherente

Plat à paella anti-adhésif
Paellapfanne, Antihalt
Round dish for paella non-stick
Paelheira valenciana anti-adherente

Ref	€	Ø (cm)	Raciones	U.Venta
60228	56,65	28	3	1
60232	65,57	32	5	1
60236	77,50	36	7	1
60240	93,59	40	9	1

ALUMINIO



Fondo FULL INDUCTION
FULL INDUCTION bottom

Incluye asas de silicona
Includes silicone handles

Paellera ECO-PIEDRA

Plat à paella
Planne
Round dish
Paelheira

Ref	€	Ø (cm)	h (cm)	Raciones	e (mm)	U.Venta
25432	64,12	32	4,5	5	1,6	1
25436	88,58	36	4,5	7	2,0	1
25440	79,27	40	4,5	9	2,0	1

Si

Silicone

Asas para paellera ECO-PIEDRA

Poignées pour plat rond
Grille for Planne
Handles for round dish
Asas para paelheira

Ref	€	Ø (cm)	U.Venta
R25435A	9,96	32-36-40	1



Paellera QUANTANIUM

Plat à paella
Planne
Round dish
Paelheira

Ref	€	Ø (cm)	h (cm)	L	U.Venta
25132	59,35	32	7,0	4,50	1

Mantiene el diseño de las paelleras clásicas y elegantes
Maintains the classic and elegant paella pan design

Asas con baño dorado
Golden bath handles



Paellera Valenciana

Plat à paella
Paellapfanne
Round dish for paella
Paelheira valenciana



Ref	€	Ø (cm)	Raciones	U.Venta
60130	53,12	30	4	1
60134	64,01	34	6	1
60138	76,15	38	8	1
60142	92,95	42	10	1
60146	110,60	46	12	1
60150	143,18	50	14	1
60155	182,19	55	16	1
60160	226,49	60	18	1



ECO-PIEDRA

Fabricadas en aluminio fundido de gran calidad y espesor, están reforzadas con partículas a base de piedra y una máxima resistencia al rayado, duración y desgaste. La base de aluminio permite una distribución homogénea del calor, permitiendo que los alimentos se cocinen rápidamente y de manera uniforme, sin apenas utilizar aceite. Su antiadherente TRICAPA de máxima calidad y ecológico, es libre de PFOA. Fácil limpieza interior y exterior gracias a protección antiadherente. Son aptas para todo tipo de fuegos y se puede lavar en el lavavajillas. Asas fabricadas en silicona de máxima calidad, termo aislantes, altamente resistentes y ergonómicas, permiten un agarre seguro en la pieza.

Fabriquées en fonte d'aluminium de grande qualité et épaisseur, elles sont renforcées par particules à base de pierre et confère une résistance maximale aux rayures et à l'usure pour allonger la durée de vie.

La base en aluminium permet une distribution homogène de la chaleur, permettant aux aliments de se cuire rapidement et de façon uniforme, sans à peine utiliser d'huile. Leur antiadhésif Tri-couche d'une qualité maximale et écologique, est sans PFOA. Intérieur et extérieur faciles à nettoyer grâce à la protection antiadhésive. Elles sont compatibles avec tout type de feux et peuvent être lavées au lave-vaisselle. Poignées fabriquées en silicone de la plus grande qualité, thermo-isolantes, hautement résistantes et ergonomiques, qui permettent de tenir l'ustensile en toute sécurité.

Made in high quality and thickness cast-aluminium, it is reinforced with stone-based particles and maximum scratch and wear resistance and durability. The aluminium base allows for a homogeneous heat distribution, allowing the food to cook quickly and uniformly without barely any oil. Its high quality and eco-friendly non-stick coating TRICAPA is PFOA-free. Easy to clean interior and exterior with its non-stick protection. They are suitable for all range cookers and they are dishwasher safe. Heat-insulating, highly resistant, ergonomic handles made of high quality silicone which provide a secure grip on pots and pans.

QUANTANIUM

Distribución homogénea del calor, permitiendo que los alimentos se cocinen rápidamente y de manera uniforme, sin apenas utilizar aceite. Antiadherente Quantanium, el primero y único antiadherente multi-capa con una mezcla de partículas de titanio. Libre de PFOA. Máxima resistencia al desgaste. Asas robustas generadas junto con la pieza en el proceso de fundición. Pueden ser utilizada en hornos convencionales hasta una temp. máx. de 285°C.

Distribution homogène de la chaleur permettant aux aliments de se cuire rapidement et de façon uniforme, sans à peine utiliser d'huile. Antiadhésif Quantanium, le premier et unique antiadhésif multicouche avec un mélange de particules de titane. Sans PFOA. Résistance maximale à l'usure. Poignées robustes créées avec la pièce lors du processus de fonte. Peuvent être utilisées dans des fours conventionnels jusqu'à une température maximum de 285°C.

The aluminium base allows for a homogeneous heat distribution, allowing the food to cook quickly and uniformly, without barely any oil. Quantanium Non-stick coating, the first and only multi-layered non-stick coating with a mix of titanium particles. PFOA-free. High resistance to wear and tear. Robust handles produced together with the piece in the casting process. Can be used in conventional ovens up to a maximum temperature of 285°C.



Paellera CHEF-ALUMINIO

Plat rond
Pfanne
Round
Paelheira

Ref	€	Ø (cm)	h (cm)	e (mm)	L	U.Venta
20628	34,96	28	7,0	2,5	4,30	1
20630	37,14	30	6,5	2,5	4,75	1
20632	39,74	32	7,0	2,5	5,50	1
20634	42,02	34	7,0	2,5	6,35	1
20636	44,41	36	7,5	2,5	7,45	1
20638	45,03	38	7,5	2,5	8,60	1
20640	53,02	40	8,0	3,0	10,05	1
20645	58,00	45	8,0	3,0	12,50	1
20650	67,54	50	8,0	3,5	15,50	1
20660	96,59	60	10,0	4,5	28,00	1



Paellera ROBUST

Plat rond
Paellapfanne
Round dish
Paelheira

Ref	€	Ø (cm)	h (cm)	U.Venta
23724	19,09	24	4,00	1
23728	25,00	28	4,50	1
23732	29,47	32	5,00	1
23736	35,59	36	5,50	1
23740	43,99	40	6,00	1

ACERO



Paellera STEEL PRO

Plat à paella
Paellapfanne
Round dish for paella
Paelheira

Ref	€	Ø (cm)	Raciones	U.Venta
63621	5,71	20	1	6
63623	5,81	22	1	6
63625	6,02	24	1	6
63627	6,64	26	2	6
63629	6,85	28	3	6
63631	7,47	30	4	6
63633	8,30	32	5	6
63635	9,03	34	6	6
63637	9,65	36	7	1
63639	10,79	38	8	1
63641	11,72	40	9	1
63643	13,49	42	10	1
63647	15,25	46	12	1
63651	18,05	50	14	1
63656	29,57	55	16	1
63661	34,96	60	19	1
63666	43,26	65	22	1
63671	61,63	70	25	1
63681	84,66	80	40	1
63691	118,28	90	50	1
63115	352,54	115	120	1
63130	731,96	130	200	1

Con 4 asas
With 4 handles

Con 6 asas
With 6 handles



Asas de acero inoxidable
Stainless steel handles

Paellera FERRUM

Plat à paella
Paellapfanne
Round dish for paella
Paelheira

Ref	€	Ø (cm)	h (cm)	e (mm)	Raciones	U.Venta
63928	37,87	28	4,5	2,5	3	1
63932	42,95	32	4,7	2,5	5	1
63936	53,54	36	5,5	2,5	7	1
63940	59,03	40	5,5	2,5	9	1



Paellera antiadherente STEEL

Plat à paella, antiadhesive
Paellaplatte, Antihalt
Round dish for paella, non stick
Paelheira anti-adereente

Ref	€	Ø (cm)	Raciones	U.Venta
60127	17,74	28	3	1
60131	20,02	32	5	1
60135	23,24	36	7	1
60139	26,04	40	9	1
60144	34,76	45	12	1
60149	41,92	50	14	1
60159	53,22	60	19	1



Esmalte vitrificado
Vitrified enamel

Paellera esmaltada SMALT

Plat à paella
Paellaplatte, emailiert
Round dish for paelle
Paelheira esmaltada

Ref	€	Ø (cm)	Raciones	U.Venta
60141	20,65	40	9	1
60151	31,64	50	14	1
60161	49,80	60	19	1

ACCESORIOS PARA PAELLERAS

Paellero Gas Butano

Rechaud
Brenner
Burner
Paelheira gas butanos

Ref	€	Ø (cm)	Quemadores	Kw	Presión (mbar)	U.Venta	Paelleras recomendadas
63731	40,15	30	1	6,50	37	1	Ø36-38-40-42-46
63741	69,51	20-40	2	11,40	37	1	Ø28-30-32-34-36-46-50-55
63751	91,82	30-50	2	14,10	37	1	Ø38-40-42-46-60-65-70
63761	129,38	20-40-60	3	21,00	37	1	Ø28-30-32-34-36-46-50-55-70-80
63771	212,69	30-50-70	3	24,50	37	1	Ø38-40-42-46-60-65-70-80-90

Válido para propano y butano - NO válidas Gas Natural y Gas Ciudad
Valid for propane and butane - NOT valid Natural Gas and Gas City



Diseñado para el Soporte Paellero
Ref. 63700
Designed for base for burner

Soporte paellero

Pied pour rechaud
Stände für Brenner
Base for burner
Cuporte paelheira

Ref	€	U.Venta
63700	39,84	1



Regulable para distintas medidas
Adjustable for different measures





UTENSILIOS UTENSILS

Juegos de cocina
Kitchen tools

Preparación
Food processing

Básculas + Termómetros
Scales + Thermometers

Cacillo

Louche
Schöpfkelle
Ladle
Concha



Ref	€	Ø (cm)	L (cm)	L	U.Venta
60306	8,82	6,50	34,5	0,07	6
60308	10,06	8,00	38,0	0,12	6
60309	10,69	9,00	46,0	0,20	6
60310	12,04	10,00	46,0	0,25	6
60312	14,11	12,00	48,0	0,50	6
60314	18,16	14,00	55,0	0,75	6
60316	18,78	16,00	55,5	1,00	6

Cacillo Perforado

Louche perforée
Schöpfkelle, gelocht
Perforated ladle
Concha perforada



Ref	€	Ø (cm)	L (cm)	L	U.Venta
61308	9,44	8	38,0	0,12	6
61310	12,24	10	46,0	0,25	6
61312	14,53	12	48,0	0,50	1

Cuchara Lisa

Cuillère lisse
Servierlöffel
Spoon
Colher lisa



Ref	€	Ø (cm)	L (cm)	U.Venta
60507	9,44	10,5	48,0	1

Cuchara Perforada

Cuillère perforée
Servierlöffel, gelocht
Perforated spoon
Colher perforada



Ref	€	Ø (cm)	L (cm)	U.Venta
60508	11,52	7,50	48,0	1

Espátula Lisa

Spatule lisse
Backschaufel
Spatula
Espátula lisa



Ref	€	cm	L (cm)	U.Venta
61410	10,58	9x10	49,5	6
61412	11,93	11x12	51,0	6

Espátula Perforada

Spatule perforée
Backschaufel, gelocht
Perforated spatula
Espátula perforada



Ref	€	cm	L (cm)	U.Venta
61411	11,41	9x10	49,50	6
61413	12,45	11x12	51,0	6

Espumadera

Ecumoire
Schaumlöffel
Skimmer
Escumadeira



Ref	€	Ø (cm)	L (cm)	U.Venta
60408	8,30	8	35,0	1
60410	10,06	10	47,0	6
60412	10,58	12	49,5	6
60414	14,11	14	57,0	6
60416	15,46	16	57,0	6

Paleta de pescado Profesional

Pelle à poisson Professionnel
Fischheber, professional
Professional long fish turner
Espátula de peixe profesional



Ref	€	cm	L (cm)	U.Venta
62988	17,12	20,5x8	37,0	12

Cuchara oblicua

Cuillère oblique
Gießlöffel, quer
Crosswire spoon
Colher oblíqua



Ref	€	cm	L (cm)	ml	U.Venta
60509	12,45	8x10	345,0	70	1

Tenedor

Fourchette
Tranchiergabel
Fork
Garfo



Ref	€	Puntas	cm	L (cm)	U.Venta
60002	13,28	2	7x8	57,5	6
60003	14,73	3	7x13	57,5	6

Espumadera alambre

Ecumoire à friture
Fritierlöffel
Skimmer
Escumadeira arame



Ref	€	Ø (cm)	L (cm)	U.Venta
60409	11,00	10	47,0	6
60411	11,93	12	49,0	6
60413	14,32	14	50,5	6
60415	15,87	16	52,0	6
60417	18,36	18	58,0	6
60419	22,31	20	59,0	6
60423	26,12	24	71,5	6
60427	32,99	28	74,0	6

Inox
18/10

Rasera alambre

Araignée à fil
Fritierlöffel
Mesh skimmer
Escumadeira arame



Ref	€	Ø (cm)	L (cm)	U.Venta
67410	11,93	10	37,0	6
67412	16,29	12	44,0	6
67415	26,15	15	55,5	6
67417	30,40	17	56,0	6
67420	37,25	20	58,0	6

Espumadera alambre

Ecumoire étamée
Fritierschaufel
Tinned skimmer
Escumadeira de arame



Ref	€	Ø (cm)	L (cm)	U.Venta
63514	10,27	14	54,0	1
63516	10,89	16	56,5	1
63518	11,31	18	56,5	1
63520	14,01	20	67,0	1
63524	15,46	24	70,5	1
63528	18,36	28	76,0	1

Alambre estañado - Tinned wire

Mango de madera

Wooden handle

**Colador doble malla**

Passoir mailles
Passiersieb, stark
Mesh strainer
Coador rede dupla

Ref	€	Ø (cm)	L (cm)	U.Venta
61316	6,95	16	32,0	1
A 61318	8,09	18	34,0	1
61320	9,34	20	37,0	1
61323	23,86	23	56,0	1
B 61326	25,04	26	58,0	1
61330	46,27	30	78,5	1
C 61335	55,82	35	84,0	1

2 Ganchos
2 Hooks

1 Gancho
1 Hook

Alambre estañado - Tinned wire

Tenedor

Fourchette étamée
Tranchiergabel
Tinned fork
Garfo



Ref	€	cm	L (cm)	U.Venta
64040	6,64	7x7	7x7	1
64060	7,78	7,5x9	7,5x9	1

Alambre estañado - Tinned wire

Inox

Nidos de alambre

Panier à nid
Nestbacklöffel
Bird's nest mould
Ninhos de arame



Ref	€	cm	L (cm)	U.Venta
62957	19,61	7-9	35	1
62959	22,93	9-11	37	1

Inox
18/10

Cazo servir "POCHON"

Pochon
Suppenkelle "Pochon" (Für server)
Pochon soup ladle for server
Caçarole servir "Pochon"



Ref	€	Ø (cm)	Mango (cm)	L (cm)	L	U.Venta
60520	51,88	20	22,50	42,5	2,00	1

Inox

Cuchara apoya utensilios

Cuillère ramasse ustensiles
Vorriegelöffel
Spoon holder utensils
Colher recolhe utensilios



Ref	€	cm	L (cm)	U.Venta
62972	9,96	25x12	25	1



Cacillo

Louche
Schöpfkelle
Ladle
Concha

Ref	€	Ø (cm)	ml	L (cm)	U.Venta
72853	9,86	6	70	24,5	6

Cuchara Lisa

Cuillère lisse
Servierlöffel
Spoon
Colher lisa



Ref	€	cm	ml	L (cm)	U.Venta
72857	9,03	5x8	100	27,5	6

Cuchara Perforada

Cuillère perforée
Servierlöffel, gelocht
Perforated spoon
Colher perfurada



Ref	€	cm	ml	L (cm)	U.Venta
72858	9,03	5x8	100	27,5	6

Espumadera

Écumoire
Schaumlöffel
Skimmer
Escumadeira



Ref	€	Ø (cm)	L (cm)	U.Venta
72854	10,89	8	27,0	6

Espátula Perforada

Spatule perforée
Pfannenschaukel, gelocht
Perforated spatula
Espátula perfurada



Ref	€	cm	L (cm)	U.Venta
72859	9,86	7x9	28,5	6

Cacillo salsa

Louche sauce
Saucengießlöffel
Gravy ladle
Concha para molho



Ref	€	cm	ml	L (cm)	U.Venta
72850	9,86	5x7,5	35	23,5	6

Pala ensalada

Pelle à salade
Salatschaufel
Salat scoop
Espátula de salada



Ref	€	cm	L (cm)	U.Venta
72851	9,34	6x8,5	28,0	6

Pala pastel perforada

Palette à gâteau perforée
Kuchenschaukel, gelocht
Perforated cake scoop
Espátula de bolos



Ref	€	cm	L (cm)	U.Venta
72856	9,86	6,5x11	31,5	6

Tenedor

Fourchette
Tranchiergabel
Fork
Garfo



Ref	€	cm	L (cm)	U.Venta
72855	7,99	4,5x9	28,5	6



Cacillo
Louche
Schöpfkelle
Ladle
Concha

Ref.	€	Ø (cm)	ml	L (cm)	U.Venta
72803	17,95	10	150	37,0	6



Cuchara Lisa
Cuillère lisse
Servierlöffel
Spoon
Colher lisa

Ref.	€	cm	L (cm)	U.Venta
72807	13,38	7x11	36,0	6



Cuchara Perforada
Cuillère perforée
Servierlöffel, gelocht
Perforated spoon
Colher perfurada

Ref.	€	cm	L (cm)	U.Venta
72808	13,59	7x11	35,5	6



Espátula Lisa
Spatule lisse
Bachschaukel
Spatula
Espátula lisa

Ref.	€	cm	L (cm)	U.Venta
72806	12,97	9x12	39,0	6



Espátula Perforada
Spatule perforée
Pfannenschaukel, gelocht
Perforated spatula
Espátula perfurada

Ref.	€	cm	L (cm)	U.Venta
72809	14,53	9x12	39,0	6



Espumadera
Ecoumire
Schaumlöfel
Skimmer
Escumadeira

Ref.	€	Ø (cm)	L (cm)	U.Venta
72804	14,94	11	37,0	6



Tenedor
Fouchette
Tranchiergabel
Fork
Garfo

Ref.	€	cm	L (cm)	U.Venta
72805	12,14	3x10	35,5	6



Cacillo salsa
Louche sauce
Saucengießlöffel
Gravy ladle
Concha para molho

Ref.	€	Ø (cm)	ml	L (cm)	U.Venta
72810	13,49	6,5	50	29,0	6



Servidor espaguetis
Cuillère à spaguétis
Spaghettheber
Spaguetti server
Servidor de espagüete

Ref.	€	cm	L (cm)	U.Venta
72811	14,01	6,5x9	34,0	6

Cacillo (62603)
Espumadera (62604)
Tenedor (62605)
Espátula (62606)
Cuchara Lisa (62607)

Juego de cocina 5 piezas pie giratorio

5 Ustensiles de cuisine sur serviteur pivotant
5 Tlg. Vorlegeteile auf Drehgestell
5 piece kitchen tool set revolving rack
Jogo de cozinha 5 peças pé giratório



Ref	€	h (cm)	U.Venta
62601	77,50		1
62630	20,54	40,0	1

Soporte - Hanging rack

Cacillo

Louche
Schöpfkelle
Ladle
Concha



Ref	€	Ø (cm)	ml	L (cm)	U.Venta
62603	14,63	10	100	31,0	6

Cuchara Lisa

Cuillère lisse
Servierlöffel
Spoon
Colher lisa



Ref	€	cm	L (cm)	U.Venta
62607	10,89	7x10	32,0	6

Cuchara Perforada

Cuillère perforée
Servierlöffel, gelocht
Perforated spoon
Colher perfurada



Ref	€	cm	L (cm)	U.Venta
62608	10,27	7x10	32,0	1

Espumadera

Ecumoire
Schaumlöffel
Skimmer
Escumadeira



Ref	€	Ø (cm)	L (cm)	U.Venta
62604	14,63	11	36,5	6

Espátula

Spatule lisse
Backschaufel
Spatula
Espátula



Ref	€	cm	L (cm)	U.Venta
62606	10,69	8x9	33,5	6

Tenedor

Fourchette
Tranchiergabel
Fork
Garfo



Ref	€	cm	L (cm)	U.Venta
62605	9,23	3x8	33,5	1

Cacillo salsa

Louche sauce
Saucengliessiöffe
Gravy ladle
Concha para molho



Ref	€	cm	ml	L (cm)	U.Venta
62609	12,76	7x9	30	31,0	1

Servidor spaguetis

Cuillère à spaguetis
Spaghettiheber
Spaghetti server
Servidor de espaguete



Ref	€	Ø (cm)	L (cm)	U.Venta
62811	12,14	7,5	31,0	6

Batidor

Fouet
Rührbesen
Whisk
Batedor



Ref	€	L (cm)	U.Venta
62812	9,55	30,00	1

▶ MONOBLOCK

Inox



Cacillo

Louche
Schöpfkelle
Ladle
Concha



Ref.	€	Ø (cm)	ml.	L (cm)	U.Venta
62503	7,16	9	100	31,5	1

Cuchara Lisa

Cullera lisa
Servieröffel
Spoon
Colher lisa



Ref.	€	cm	L (cm)	U.Venta
62507	5,71	6,5x10	34,5	1

Espumadera

Ecumoire
Schaumöffel
Skimmer
Escumadeira



Ref.	€	Ø (cm)	L (cm)	U.Venta
62504	7,26	11,5	35,0	1

Espátula

Spatule lisse
Backschaufel
Spatula
Espátula



Ref.	€	cm	L (cm)	U.Venta
62506	5,60	8x10	35,5	1

Tenedor

Fourchette
Tranchiergabel
Fork
Garfo



Ref.	€	cm	L (cm)	U.Venta
62505	4,88	2,5x10	33,5	1



Cuchara lisa

Cuillère
Servieröffel
Spoon
Colher lisa

Ref	€	cm	L (cm)	U.Venta
68270	7,06	7x10,5	36,5	6



Cacillo

Louche
Schöpfkelle
Ladle
Concha

Ref	€	cm	ml	L (cm)	U.Venta
68271	7,26	10,5x9,5	100	33,5	6



Espumadera

Écumoire
Schaumlöffel
Skimmer
Escumadeira

Ref	€	cm	L (cm)	U.Venta
68272	7,06	10,5x10,5	36,5	6



Servidor Spaguetis

Cuillère à spaguettis
Spaghettiheber
Spaghetti server
Servidor de espaguetis

Ref	€	cm	L (cm)	U.Venta
68273	6,85	6,5x9,5	36,5	6



Espátula

Spatule
Schaufel
Spatula
Espátula

Ref	€	cm	L (cm)	U.Venta
68274	7,26	8,5x10,5	37,5	6



Espátula perforada

Spatule perforée
Schaufel, Gelecht
Perforated spatula
Espátula perforada

Ref	€	cm	L (cm)	U.Venta
68275	7,16	8,5x10,5	37,5	6



Paleta de pescado

Pelle à poisson
Fischheber
Fish turner
Espátula de peixe

Ref	€	cm	L (cm)	U.Venta
68276	7,26	8x14,5	36,5	6



Cacillo

Louche
Schöpfkelle
Ladle
Concha

Ref	€	cm	ml	L (cm)	U.Venta
98903	3,32	8x9,5	125	31,0	12



Espumadera

Ecumoire
Schaumlöffel
Skimmer
Escumadeira

Ref	€	Ø (cm)	L (cm)	U.Venta
98904	3,32	11	33,0	12



Cuchara salsa

Cuillère sauce
Saucenservierlöffel
Gravy spoon
Colher para molho

Ref	€	cm	L (cm)	U.Venta
98905	3,32	7,5x9	25,0	12



Espátula perforada

Spatule perforée
Schaufel, Gelocht
Perforated spatula
Espátula perforada

Ref	€	cm	L (cm)	U.Venta
98906	3,32	9x10	31,0	12



Cuchara lisa

Cuillère
Servierlöffel
Spoon
Colher lisa

Ref	€	cm	L (cm)	U.Venta
98907	3,32	6,5x10	30,0	12



Cuchara perforada

Cuillère perforée
Servierlöffel, gelocht
Perforated spoon
Colher perfurada

Ref	€	cm	L (cm)	U.Venta
98908	3,32	6,5x9	30,0	12



Paleta de pescado

Pelle à poisson
Fischheber
Fish turner
Espátula de peixe

Ref	€	cm	L (cm)	U.Venta
98909	3,32	8x16	32,0	12



Cacillo salsa

Louche sauce
Saucengliedlöffel
Gravy andle
Concha para molho

Ref	€	cm	ml	L (cm)	U.Venta
98910	3,32	6x8,5	30	27,0	12



Servidor Spaguetis

Cuillère à spaguetis
Spaghettiheber
Spaguetti server
Servidor de esparguete

Ref	€	cm	L (cm)	U.Venta
98911	3,32	6x8	30,0	12



Espátula corta

Spatule court
Palette, Kurz
Short spatula
Espátula corta

Ref	€	cm	L (cm)	U.Venta
98912	3,32	8x12	28,0	12



Espátula larga

Spatule longue
Palette, Lang
Long spatula
Espátula comprida

Ref	€	cm	L (cm)	U.Venta
98913	3,32	4x7	31,0	12



Batidor

Fouet
Schneebesen
Whisk
Batedor

Ref	€	cm	L (cm)	U.Venta
98914	3,32	7x7	30,0	12



Cacillo

Louche
Schöpfkelle
Ladle
Concha



Ref	€	Ø (cm)	ml	L (cm)	U.Venta
98803	4,36	9,5	110	29,0	12



No rayan.
Pensades para rendir a la perfección con piezas antiadherentes.

Ils ne rayent pas.
Conçus pour une efficacité optimum avec récipients antiadhésifs.

Kein Verkratzen
Ideal für Topfe und Pfannen mit Antihaftbeschichtung.

They do not scratch.
Designed to perform perfectly with non-stick parts.

Não riscam.
Pensados para tirar o máximo rendimento e perfeição com peças anti-adherentes.

Cuchara Lisa

Cuillère
Servierlöffel
Spoon
Coíther lisa



Ref	€	cm	L (cm)	U.Venta
98807	3,63	7,5x10	30,5	12

Cuchara Perforada

Cuillère perforee
Servierlöffel, gelocht
Perforated spoon
Coíther perforada



Ref	€	cm	L (cm)	U.Venta
98808	3,63	7,5x10	30,5	12

Espumadera

Ecumoire
Schaumlöffel
Skimmer
Escumadeira



Ref	€	Ø (cm)	L (cm)	U.Venta
98804	4,15	11	31,5	12

Cacillo salsa

Louche sauce.
Saucengießlöffel.
Gravy ladle
Concha para molho



Ref	€	cm	ml	L (cm)	U.Venta
98810	3,32	8x6,5	40	27,0	12

Espátula perforada

Spatule perforee
Schaufel, gelocht
Perforated spatula
Espátula perforada



Ref	€	cm	L (cm)	U.Venta
98806	3,74	8x10	33,0	12

Servidor Spaguetis

Cuillère à spaguëti
Spaghettihöber
Spaguëti server
Servidor de esparguete



Ref	€	Ø (cm)	L (cm)	U.Venta
98811	3,42	7,5	29,0	12

Cuchara lisa

Cuillère
Servieröfel
Spoon
Colher lisa



Ref	€	cm	L (cm)	U.Venta
68175	5,29	6x10	30,0	6



Imprescindible en cualquier cocina por su resistencia a altas temperaturas y durabilidad.

Conserva mejor los sabores de los alimentos al cocinarlos. Fabricadas en madera haya natural de alta calidad, acabadas con aceites naturales.

Mango que hace muy fácil el agarre y el manejo en la cocina.

Apta para uso en sartenes con revestimiento antiadherente.

Indispensable dans toute cuisine en raison de sa résistance aux hautes températures et sa durabilité.

Conserve mieux les saveurs des aliments lors de leur cuisson. Fabricées en hêtre naturel de grande qualité et dotées d'une finition aux huiles naturelles.

Manche qui rend très facile la prise en main et la manipulation dans la cuisine. Apté pour un usage sur des poêles avec revêtement antiadhésif cuisine.

Sehr temperaturbeständig und langlebig und daher in jeder Küche unentbehrlich.

Geschmack der Lebensmittel bleibt beim Kochen besser erhalten. Aus naturbelassenem Buchenholz von hoher Qualität und mit organischer Lasur. Handgriff, der das Greifen und die Handhabung in der Küche erleichtert. Zur Verwendung mit antihaftbeschichteten Pfannen geeignet.

Essential in any kitchen because of their resistance to high temperatures and their durability.

Better preserve the flavours of cooked food. Made from natural beech wood of high quality and finished with natural oils. Handle making it very easy to pick up and manipulate when cooking. Suitable for use in frying pans with non-stick coating.

Imprescindível em qualquer cozinha pela sua durabilidade e resistência a altas temperaturas.

Conservam melhor os sabores dos alimentos ao cozinhá-los. Fabricados em madeira de fave natural de alta qualidade e com acabamento de óleos naturais.

Mango que facilita o agarre e o manejo na cozinha.

Apta para uso em sartens com revestimento antiaderente.

Cuchara perforada

Cuillère perforée
Servieröfel, gelocht
Perforated spoon
Colher perfurada



Ref	€	cm	L (cm)	U.Venta
68176	5,60	7x10	30,0	6

Espátula lisa

Spatule
Backschaufel
Spátule
Espátula lisa



Ref	€	cm	L (cm)	U.Venta
68177	5,29	6,5x10	30,0	6

Espátula perforada

Spatule perforée
Backschaufel, gelocht
Perforated spatule
Espátula perfurada



Ref	€	cm	L (cm)	U.Venta
68178	5,50	7,5x12	30,0	6

Cuchara ensalada

Cuillère à salade
Salat-Servieröfel
Salad spoon
Colher de salada



Ref	€	cm	L (cm)	U.Venta
68173	6,12	8x7	30,0	6

Cuchara especial

Cuillère spécial
Salat-Servieröfel
Special spoon
Colher especial



Ref	€	cm	L (cm)	U.Venta
68179	5,71	6,5x10	30,0	6

Tenedor ensalada

Fourchette à salade
Salat-Gabel
Salad fork
Garfo de salada



Ref	€	cm	L (cm)	U.Venta
68174	6,12	8x7	30,0	6

Bambú natural
Natural bamboo



Asa de silicona
Silicone handle

Cuchara-Tenedor ensalada GREY

Cuillère-Fourchette à salade
Salatbesteck
Salad spoon-fork
Garfo-Colher de salada

Ref	€	cm	L (cm)	U.Venta
68183	7,89	6,5x8	32,0	6 Cuchara - Spoon
68184	7,89	5,5x8	32,0	6 Tenedor - Fork



Fabricadas en bambú natural, un complemento ideal para cualquier cocina. Conserva los sabores de los alimentos al cocinarlos.

Robustos y muy resistentes por su resistencia a altas temperaturas. Permiten remover los alimentos sin rayar las cacerolas y sartenes con antiadherente.

Mango de silicona, facilita el agarre y manejo en la cocina.

Fabricadas en bambou naturel, il s'agit d'un accessoire idéal pour tout type de cuisine.

Conserva los sabores de los alimentos al cocinarlos.

Robustos y muy resistentes por su resistencia a altas temperaturas.

Permiten remover los alimentos sin rayar las cacerolas y las poêles avec antiadhésif.

Manche en silicone, qui facilite la prise en main et la maniabilité dans la cuisine.

Aus Naturbambus gefertigt, das ideale Zubehör für jede Küche.

Behält die Aromen der Speisen beim Kochen.

Robust und sehr widerstandsfähig wegen seiner hohen Temperaturbeständigkeit.

Arbeiten in Töpfen und Pfannen ohne die Antihaftbeschichtung zu beschädigen. Silikon-Griff für leichteres Fassen und Handhabung in der Küche.

Made of natural bamboo, it is the perfect accessory for any kitchen.

Preserves the flavours of food when cooking.

Robust and highly durable thanks to their resistance to high temperatures.

Enable you to stir food without scratching pots and pans with non-stick coating.

Silicon handle for easy grip and handling in the kitchen.

Fabricadas em bambu natural, um complemento ideal para qualquer cozinha.

Conserva os sabores dos alimentos ao cozinhá-los.

Robustos e resistentes a altas temperaturas.

Permitem remover os alimentos sem riscar as caçarolas e as sartãs antiaderente.

Mango de silicone, que facilita a sujeição e o manejo na cozinha.

▶ ESPÁTULA/CUCHARA SONDA



2 en 1
2 in 1



Espátula
Funda de silicona extraíble
Spatula
Removable silicone sleeve

Termómetro
Sonda de acero inoxidable
Thermometer
Stainless steel probe



Espátula silicona con termómetro sonda

Spatule en silicone avec Thermometre sonde
Teigschaber mit Thermometer/Sonde
Silicone spatula with Thermometer probe
Espátula silicone com Termómetro sonda

Ref	€	L (cm)	U.Venta
62500	13,90	25	1

2 en 1
2 in 1



Cuchara
Funda de silicona extraíble
Spoon
Removable silicone sleeve

Termómetro
Sonda de acero inoxidable
Thermometer
Stainless steel probe



Cuchara silicona con termómetro sonda

Cuillère en silicone avec Thermometre sonde
Löffel mit Thermometer/Sonde
Silicone spoon with Thermometer probe
Colher silicone com Termómetro sonda

Ref	€	L (cm)	U.Venta
62528	14,94	25	1

UTENSILIOS



Sección cuadrada
(2,5x2,5 mm)
Square section

Inox
18/10

Pincho moruno (6) Inox

Brochette carne en inox. (6)
Fleischspiesse (6), Roestfri
St. steel skewers square wire (6)
Espeto moruno Inóx (6)

Ref	€	L (cm)	U. Venta
62446	4,25	20,0	12
62435	4,88	30,5	12
62445	5,81	40,5	12



Inox

Contenedor de cubiertos

Panier à couverts
Besteckköcher
Cutlery holder
Copos para talheres



Ref	€	Ø (cm)	h (cm)	L	U. Venta
62962	18,26	12	13,6	1,40	1
62963	21,17	12	18,7	2,00	1

AL

Aluminium

Barra sujeción notas aluminio

Barre à notes en Aluminium
Zettelhalter, Aluminium
Aluminium Order rail
Barra fixação notas aluminio

Ref	€	L (cm)	U. Venta
60731	10,17	30,50	1
60746	13,28	46,00	1
60761	15,87	61,00	1
60776	18,26	76,00	1
60791	22,72	91,50	1



Inox
18/10

Cotgador de barra

Penderie murale
Hängeleiste
Wall hanger
Suporte de barra

Ref	€	Unidades	L (cm)	U. Venta
60740	19,51	6	40	1
60760	26,98	8	60	1
60710	37,35	12	100	1



Inox
18/10

Juego de 6 ganchos

Ensemble 6 crochets
Aufhängehaken, 6er.-Set
6 hook set
Jogo de 6 ganchos

Ref	€	U. Venta
60700	5,81	12



Inox
18/10

6 ganchos carnicero 1 punta

6 crochets de boucher 1 conseil
6-Tig Metzgerhaken, 1 spitze
6 butchers hook 1 point
6 ganchos de carnicero 1 punta

Ref	€	Ø (mm)	L (cm)	U. Venta
A 39043	9,96	5	12,5	4
B 39044	15,46	5	18,5	1



Inox
18/10

6 ganchos carnicero 2 puntas

6 crochets de boucher 2 conseils
6-Tig Metzgerhaken, 2 spitzen
6 butchers hook 2 points
6 ganchos de carnicero 2 puntas

Ref	€	Ø (mm)	L (cm)	U. Venta
A 39047	9,96	5	12,5	4
B 39048	15,46	5	18,5	1

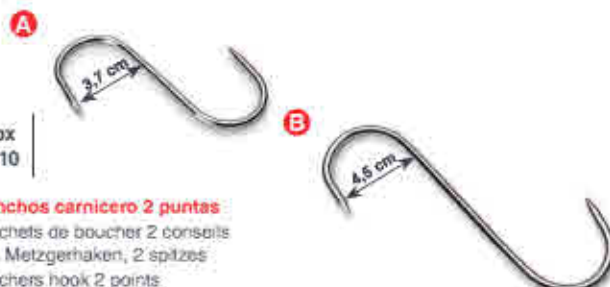



Lacor

Preparación
Food Processing

#CocinaConLacor

▶ ESPÁTULAS INOX



Gran flexibilidad, ideal para voltear los alimentos.
Su borde biselado ayuda a deslizarse debajo de los alimentos.
Las ranuras de la espátula permiten que la grasa se escurra.

Grande flexibilité, idéale pour retourner les aliments.
 Son bord biseauté aide à se glisser sous les aliments.
 Les rainures de la spatule permettent à la graisse de s'écouler.

Kelle mit extra viel Flexibilität. Eignet sich ideal zum schonenden Wenden.
 Die abgeschrägte Kante gleitet problemlos unter das Kochgut.
 Mit festabführenden Lamellen.

Highly flexible, perfect for turning over food.
 Its bevelled edge helps it slide under food.
 The grooves on the spatula let fat flow away.

Grande flexibilidade, ideal para voltear os alimentos.
 O seu rebordo biselado permite-lhe deslizar mais facilmente debaixo dos alimentos.
 As ranhuras da espátula permitem que a gordura esorra dos alimentos.



Espátula flexible pescado

Spatule flexible à poisson
 Fisch Schaufel, flexible
 Flexible spatula to fish
 Espátula flexível para peixe

Ref	€	L (cm)	U.Venta
60426	5,84	30	6

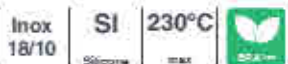

Espátula de pescado PRO

Spatule à poisson
 Fischheber
 Fish spatula
 Espátula de peixe

Ref	€	L total (cm)	Paleta (cm)	U.Venta
60726	11,52	30	18x8	1

Espátula grill acodada

Spatule coudée our grill
 Winkelpalette
 Bent grillspatula
 Espátula comprida greina



Ref	€	cm	U.Venta
60434	4,98	12x27	6



Paleta triangular mango sólido

Grattoir manche noir m/solide
 Bratenspachtel, mit solidem Stiel
 Straight Scraper/turner
 Espátula triangular cabo sólido

Ref	€	cm	U.Venta
60430	5,81	10x11,5	12



2 in 1

Cortar - Cut

Servir
 Serve up

Espátula serrada

Spatule à gâteau
 Backschaufel
 Serrated spatula
 Espátula com serrinha

Ref	€	cm	U.Venta
62677	7,57	30x5,5	6

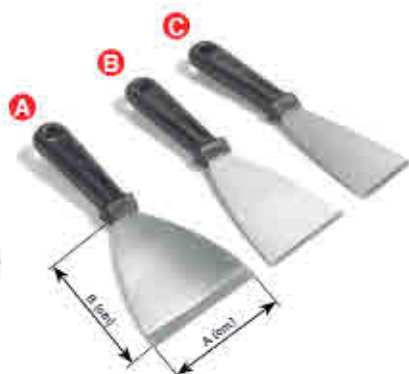
**Espátula plancha mango sólido**

Spatule m/solide
Grillspachtel, mit solidem Stiel
Straight spatula
Espátula grelha cabo sólido

Ref	€	A (cm)	B (cm)	U.Venta
A 60422	3,94	10	11,5	12
B 60445	3,42	8	11,5	12
C 60446	3,32	6	11,5	12

**Espátula lisa mango sólido**

Spatule lisse m/solide
Bäckschaufel, f. Feststoffe
Straight spatula
Espátula lisa cabo sólido

Ref	€	cm	U.Venta
60425	4,15	7x13,5	12

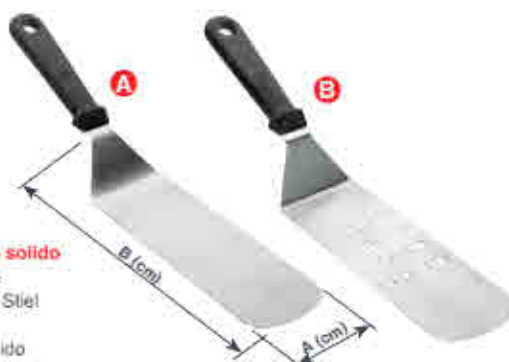
**Espátula lisa mango sólido**

Spatule lisse m/solide
Spachtel, mit solidem Stiel
Straight spatula
Espátula lisa cabo sólido

Ref	€	AxB (cm)	U.Venta
A 60420	4,67	7,5x21,5	12
B 60421	4,57	7,5x21,5	12

**Espátula mango negro**

Spatule manche noir
Schaufel mit schwarzem Stiel
Solid turner w/black H.
Espátula cabo negro

Ref	€	AxB (cm)	L (cm)	U.Venta
A 60435	6,54	7,5x17	35	6
B 60438	6,64	7,5x17	35	6

**Espátula mini acodada**

Mini spatule coudée
Winkelpalette Mini
Mini bent spatula
Espátula mini comrida

Ref	€	cm	U.Venta
60442	3,22	2x9	12

**Espátula repostería**

Pâtisserie spatule
Gebäckpalette
Pastry spatula
Espátula pastelaria

Ref	€	cm	U.Venta
60443	3,53	6,5x14,5	12

**Espátula larga recta mango sólido**

Spatule longue droite m/solide
Palette, lang, gerade
Long straight spatula
Espátula comrida c/cabo sólido

Ref	€	L (cm)	U.Venta
60461	3,22	15	12
60462	3,32	20	12
60463	3,42	25	12
60464	3,53	30	12
60465	3,63	35	12

**Espátula larga acodada mango sólido**

Spatule longue coudée m/solide
Winkelpalette, lang
Long bent spatula
Espátula comrida c/cabo sólido

Ref	€	L (cm)	U.Venta
60467	3,42	20	12
60468	3,53	25	12
60469	3,63	30	12



Inox
18/10

Espátula gigante Inox

Spatule géante en Inox
Rührspatel, Edelstahl
St steel long handle Turner
Espátula gigante, Inóx



Ref.	€	L (cm)	U.Venta
61481	58,41	80	1
61421	63,91	120	1



Pala Profesional Polietileno

Pelle Professionnelle Polyéthylène
Professionelle Rührspatel, Polyethylen
Polyethyène Professional shovel
Pá Professional Polietileno

Ref.	€	L (cm)	U.Venta
60404	67,65	81,5	1



Pala Pizza mango desmontable

Pelle Pizza manche démontable
Pizzaofen-Schaufel, viereckig
Square Pizza oven scoop
Pá de pizza cabo desmontável

Ref.	€	L (cm)	U.Venta
61460	90,26	160	1

Inox
18/10

Espátula pizza

Spatule pizza
Pizzaspatel
Pizza spatula
Espátula pizza



Ref.	€	cm	U.Venta
60424	12,14	16,5x17,5x5	12



ABS
Plastic

Pala Pizza

Pelle pizza
Pizzaschaufel, flach
Pizza flat scoop
Espátula Pizza



Ref.	€	cm	U.Venta
61461	12,35	25x36	1



Cortapizza

Roulette pizza
Pizzaschneider
Pizza cutter
Corta-Pizza

Ref.	€	Ø (cm)	U.Venta
A 60429	4,36	10	12
B 67004	15,36	10	1
C 67028	10,69	10	1
D 67027	5,08	8	6

▶RASQUETAS



Amasa, corta y limpia.

Indispensables a la hora de trabajar con masas.

Nos ayudan tanto a moverlas en el amasado como cortarlas gracias a su filo. Gran ayuda a la hora de limpiar la superficie de trabajo eliminando los restos.

Pétrir, aplatir et nettoyer.

Indispensables lorsque l'on travaille avec la masse.

Ils nous aident à la fois à se déplacer dans le pétrissage et la coupe de pointe grâce à son.

Grande aide lors du nettoyage de la surface de travail en enlevant des restes.

Kneten, schneiden und reinigen.

Unverzichtbar beim Kneten und Schneiden der Masse.

Große Hilfe beim Reinigen der Arbeitsfläche durch Entfernen der Überreste.

Knead, slice and cleaning.

Indispensables when working with mass.

We help both move in the kneading and cutting edge thanks to its

Great help when cleaning the working surface by removing debris.

Amasse, short e limpezã.

Indispensáveis quando se trabalha com massa.

Nós ajudamos tanto movimento no amassamento e corte graças à sua ponta.

Grande ajuda para limpar a superfície de trabalho remoção de detritos.

Inox

Rasqueta
Coupe pate
Schaufel
Scraper
Raspador



Escala de medición
Measurement scale



Ref	€	cm	U.Venta
67029	8,20	16,5x10,5	6

Inox
18/10

Rasqueta
Coupe pate
Schaber
Scraper
Raspador



Ref	€	cm	U.Venta
A 67005	11,21	15x9	6
B 67006	10,79	15x9	6

SI

230°C



Silicone

max.

S.P.S.

Rasqueta silicona

Coupe pate en Silicone

Schaber, Silikon

Silicone scraper

Raspador silicone



Ref	€	cm	U.Venta
67414	7,78	9x15	1

▶ ESPÁTULAS SILICONA



Espátula Silicona
Spatule en silicone
Teigschaber
Silicone spatula
Espátula de silicone

Ref	€	L (cm)	U.Venta
67434	4,05	30	12
67435	4,67	29	12



Espátula Silicona
Spatule en silicone
Teigschaber
Silicone spatula
Espátula de silicone

Ref	€	L (cm)	U.Venta
64450	4,88	25	6
A 64451	7,78	35	6
64460	5,08	25	6
B 64461	8,51	35	6

Inox
18/10
Mangas Herramientas



Espátula Silicona
Spatule en silicone
Teigschaber
Silicone spatula
Espátula de silicone

Ref	€	L (cm)	U.Venta
67421	3,94	20	1
67427	5,91	26	1
67433	12,97	32	1



Espátula Silicona
Spatule en silicone
Teigschaber
Silicone spatula
Espátula de silicone

Ref	€	L (cm)	U.Venta
A 64444	5,08	28	1
B 64445	5,71	30	1
C 64446	5,81	31	1



Utensilios de silicona GREY
Utensiles en silicone
Silikonutensilien
Silicone utensils
Utensílios de silicone

Ref	€	L (cm)	U.Venta	
A 64463	4,46	27,5	1	Cuchara / Spoon
B 64464	4,36	27,5	1	Espátula / Spatula
C 64465	4,36	27,5	1	Pincel / Brush

Set repostería (20 pcs.)

Exposant pâtisserie
Aussteller Pastry
Pastry display
Expositor pastelaria

Ref	€	L (cm)	Pieza	U.Venta
A 64424	66,09	-	Caja (20 pcs) / Set (20 pcs)	1
B 64426	3,32	23,0	Pincel / Brush	12
C 64427	3,32	23,0	Espátula / Spatula	12
D 64428	3,32	23,0	Lengua gato / Spatula	12
E 64429	3,32	23,0	Batidor / Whisk	12



BATIDORES



Inox
18/10



Indispensables en la cocina. Prácticos y duraderos.
Gracias a su diseño permite batir en pocos movimientos debido a la distribución independiente de sus varillas.
Ideales para mezclar y batir los alimentos.
Anillo integrado para colgar.

Indispensables dans la cuisine. Pratiques et durables.
Leur conception leur permet de battre en très peu de mouvements grâce à la distribution indépendante de leurs tiges.
Parfaits pour mélanger et battre les aliments.
Anneau intégré pour suspendre.

Essenzieller Küchenhelfer Praktisch und haltbar.
Schwungbesen mit unabhängiger Verteilung der einzelnen Glieder schlägt Ruhigut im Nu.
Ideal zum Mischen und Schlagen.
Mit Öse zum Aufhängen.

Essential for any kitchen.
Practical and durable.
Its whisks are freely distributed allowing you to mix with ease.
Ideal for mixing and whisking food.
Built-in ring allowing easy storage.

Indispensável na cozinha. Práticos e duráveis.
O seu desenho de vareta independente permite bater em poucos movimentos.
Ideais para bater e misturar os ingredientes.
Anel para pendurar integrado.



Batidor EXTRA 8

Fouet inox extra 8
Schneebeesen, Extra 8
Extra 8 whisk
Batedor Extra 8

Ref	€	L (cm)	Ø Varilla (mm)	U.Venta
61625	7,47	25	2,3	12
61630	7,57	30	2,3	12
61635	7,99	35	2,3	12
61640	8,82	40	2,3	12
61645	9,44	45	2,3	12
61650	10,69	50	2,3	12
61655	11,21	55	2,3	1
61660	12,14	60	2,3	1

Batidor MINI inox

Mini fouet inox
Mini-Schneebeesen
Mini whisk
Mini batedor inox

Ref	€	L (cm)	U.Venta
61615	4,67	15	1
61620	5,19	20	1



Batidor SUPER 12

Fouet inox super 12
Schneebeesen, super 12
Super 12 whisk
Batedor Super 12

Ref	€	L (cm)	Ø Varilla (mm)	U.Venta
61626	6,85	25	2,3	12
61631	7,37	30	2,3	12
61636	7,99	35	2,3	12
61641	8,40	40	2,3	12
61646	8,72	45	2,3	12
61651	9,44	50	2,3	6



SI

250°C

Silicone

max



Batidor varilla silicona

Fouet en silicone
Rührbesen auf Silikon
Silicone wire whisk
Batedor vareta silicone

Ref	€	L (cm)	U.Venta
61621	7,06	20	12
61622	7,78	25	12
61623	8,72	30	12



Batidor FIBREGLASS

Fouet FIBREGLASS
FIBREGLASS Schneebesen
FIBREGLASS Whisk
Batidores FIBREGLASS

Ref	€	L (cm)	U.Venta
61624	10,38	25	1
61629	11,93	30	1
61634	13,49	35	1
61639	14,94	40	1
61644	17,85	45	1
61649	18,78	50	1



Ergonómico
Ergonomic



Batidor silicona FIBREGLASS

Fouet en silicone FIBREGLASS
FIBREGLASS Schneebesen, Silikon
FIBREGLASS silicone whisk
Batidores silicona FIBREGLASS

Ref	€	L (cm)	U.Venta
61524	9,44	25	1
61529	10,27	30	1
61534	11,93	35	1
61539	12,45	40	1



Ergonómico
Ergonomic



Batidor de varillas con raspador de silicona

Fouet avec grattoir en silicone
Schneebesen mit Silikon-schaber
Whisk with built-in silicone
Batedeira de varas com raspador de silicone

Ref	€	L (cm)	U.Venta
61627	5,50	32	1



2 en 1
Baté y recoge toda la mezcla
del bol de forma fácil y rápida

2 in 1
Beat and scrape out the entire mixture
from the bowl quickly and easily.



Batidor de varillas
Ø varilla: 2 mm
Rod whisk
Ø rod: 2 mm



Espátula
Spatula

New

Batidor Gigante

Fouet à purée
Kesselbesen
Big whisk
Batidor gigante

Ref.	€	cm	Ø Varilla (mm)	U.Venta
60610	53,74	100	3	1
60612	68,79	129	3	1



Inox

Batidor manivela

Batteur-mélangeur à manivelle
Schneequirl
Egg beater
Batidor de manivela

Ref	€	U.Venta
62901	16,39	6



Varillas Inox
Rods Inox



Batidor Capuccino electrónico

Batteur pour Cappuccino électronique
Elektronischer Cappuccino-Mixer
Electronic cappuccino mixer
Batidor capuccino Electrónico

Ref	€	W	U.Venta
69041	22,51	2,7	1



PINCELES



El toque especial para tus mejores platos
The special touch to your best dishes

Pincel virola inox mango Polipropileno

Pinceau pâtisier V. Inox M. Polipropylène
Fett-/Kucherpinsel, mit Stiel aus Polypropylen, schaff Edelstahl
Flat pastry brush s.steel Polypropylene handle
Pincel aro Inóx cabo polietileno



Ref	€	L (cm)	Cerdas(cm)	U.Venta
64430	3,74	23,0	4,4x3,0	1
64435	4,36	24,0	4,4x3,5	1
64440	4,57	24,5	4,4x4,0	1
65044	5,60	25,0	5,0x4,5	1
65050	6,64	26,0	5,0x5,0	1

Para cocina o repostería.

Ideales para pincelar con aceites o salsas, marinar carnes o pescados, engrasar moldes, untar con aceite, huevo batido, almibar, etc. No absorben olores ni sabores.

Pour la cuisine ou la pâtisserie.

Parfaits pour badigeonner de l'huile ou des sauces, mariner des viandes ou des poissons, graisser des moules, étaler de l'huile, de l'oeuf battu, du sirop, etc. N'absorbent ni les odeurs ni les goûts.

Zum Kochen oder Backen.

Ideal zum Einstrichen mit Öl, Sauce, Marinieren von Fleisch oder Fisch. Einfetten von Backformen, zum Eindeten, zum Bestreichen mit Ei oder Sirup usw. Nehmen weder Geschmack noch Geruch an.

For cooking or baking.

Ideal for brushing oils or sauces, marinating meat or fish, greasing baking tins, and basting with oil, egg, syrup, etc. Doesn't absorb smells or tastes.

Dimensiones Reales - Real Dimensions

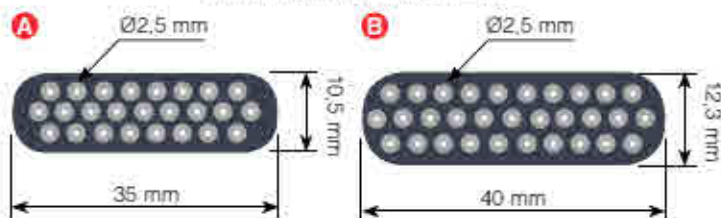

Para cozinha ou pastelaria.

Ideais para pincelar com óleos ou molhos, marinar carnes ou peixes, untar formas, untar com óleo, ovo batido, calda, etc. Não absorvem odores nem sabores.

210°C

Pincel de silicona mango Inox

Pinceau de cuisine embout en silicone
Silikonpinsel, langer stiel
Silicone brush st. steel long handle
Pincel de silicone cabo Inóx 18/10



Ref	€	L (cm)	U.Venta
A 64425	5,81	24	12
B 64431	6,23	24	12

180°C

Pincel de Silicona

Pinceau en silicone
Silikonpinsel
Silicon brush
Pincel de silicone



Ref	€	L (cm)	U.Venta
64441	5,81	23	1

Inox 18/10 230°C



Pincel de Silicona

Pinceau en silicone
Silikonpinsel
Silicon brush
Pincel silicone

Ref	€	L (cm)	U.Venta
A 64418	9,34	22	1
B 64422	10,58	23	1
C 64438	11,62	24	1

▶ UTENSILIOS HUEVO



Fabricado en acero inoxidable 18/10, garantiza resistencia, durabilidad e higiene. Asegura una separación limpia.

Fabriqués en acier inoxydable 18/10, il garantit résistance, durabilité et hygiène. Garantit une séparation propre.

Aus nicht rostendem 18/10-Stahl hergestellt, garantiert strapazierfähig, langlebig und hygienisch. Sorgt für saubere Trennung.

Made from 18/10 stainless steel, resistance, durability and hygiene are guaranteed. Ensures clean separation.

Fabricado em aço inoxidável 18/10, que lhe oferece uma grande resistência, durabilidade e higiene. Assegura uma separação limpa.

Inox

Molde huevo-sandwich

Moule à oeufs sandwich
Eier/Sandwichring
Mould for egg-sandwich
Molde ovo-Sandwich

	Ref	€	cm	U.Venta
A	68005	2,80	Ø8,5	12
B	68005	2,80	8,5x8,5	12

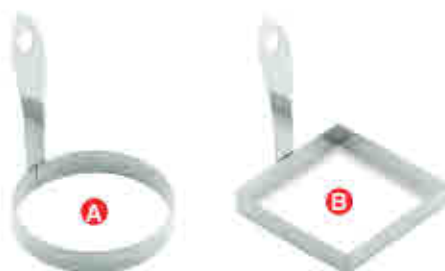

Inox
18/10

Separador de claras

Séparateur à oeuf
Eier-Separator
Eggs separator
Separador de ovos

Ref	€	U.Venta
61608	6,54	6



SI

230°C



Silicone

max.

DAI

Molde huevo redondo silicona

Moule à oeufs rond en silicone
Silikon Eierform
Silicone round shape egg mould
Molde ovo redondo de silicone

Ref	€	cm	U.Venta
68080	5,40	Ø10x2	1



Inox
18/10

Soporte huevo OVUM

Support d'oeufs
Eierbecher
Egg stand
Suporte de ovo

Ref	€	Ø (cm)	h (cm)	U.Venta
68285	2,49	4,5	5	6



SI

230°C



Silicone

max.

DAI

Molde huevo corazón silicona

Moule à oeufs coeur en silicone
Silikon Herzform
Silicone heart shape egg mould
Molde ovo coração de silicone

Ref	€	cm	U.Venta
68082	5,40	10,5x10,5x2	1



Inox
18/10

SI

Silicone



Abridor huevos OVUM

Oeufs ouvrir
Eierköpfer
Egg opener
Ovos abridor

Ref	€	Ø (cm)	h (cm)	U.Venta
68285	10,58	4,5	5,5	1



JARRA INFUSORA



**Ideal para preparar bebidas de frutas 100% naturales.
Con tapa anti derrames para verter sin problema.
Filtro infusor en el centro para frutas y verduras.
Fácil de usar y perfecta para un estilo de vida saludable.**

**Idéal pour préparer des boissons aux fruits 100% naturelles.
Dispose d'un couvercle anti fuites pour verser sans problème.
Filtre infuseur au centre pour les fruits et les légumes.
Facile à utiliser et parfait pour un mode de vie sain.**

**Ideal zum Bereiten natürlicher Fruchtsäfte geeignet.
Deckel mit Überlaufschutz für problemloses Eingießen.
Filtereinsatz für Obst und Gemüse.
Einfach zu verwenden und ideal für den gesunden Lebensstil.**

**Ideal for preparing 100% natural fruit drinks.
With non-spill lid for easy pouring.
Infusion filter in the centre for fruits and vegetables.
Easy to use and perfect for a healthy lifestyle.**

**Idéal para preparar bebidas de fruta 100% naturales.
Tapa anti-derrama, para verter o líquido sem problemas.
Filtro infusor no centro, para frutas e verduras.
Fácil de usar, ideal para um estilo de vida saudável.**



Desenroscar la tapa girándola en sentido anti-horario

Dévisser le couvercle dans le sens inverse des aiguilles d'une montre.
Deckel im Gegenuhzeigersinn abschrauben.
Unscrew the lid by turning it counter-clockwise.
Desenroscar a tampa girando-a no sentido anti-horário.



Introducir la fruta, hierbas o semillas

Mettre de la fruit, les herbes ou les graines.
Geschüttetes Obst, Kräuter oder Samen herein geben.
Introduce the fruit, herbs or seeds.
Introduzir a fruta, ervas ou sementes.



Enroscar la tapa girándola en sentido horario

Resser le couvercle en le faisant tourner dans le sens des aiguilles d'une montre.
Deckel im Uhrzeigersinn einschrauben.
Screw on the lid by turning it clockwise.
Enroscar a tampa girando-a no sentido horário.



Introducir el filtro dentro de la jarra y presionar la tapa hasta cerrarla

Introduire le filtre dans le potier et appuyer sur le couvercle jusqu'à sa fermeture.
Filter in das Gefäß einführen und Deckel zum Schließen festsetzen drücken.
Put the filter in the pitcher and push the lid until it's closed.
Introduzir o filtro no interior da jarra, e pressionar a tampa até fechá-la.



Jarra infusora
Pitchet infuseur
Krug mit Filter
Infusion pitcher
Jarra infusionadora

Ref	€	cm	L	U.Venta
61954	26,56	19x16x29	2,40	1



JARRAS MEDIDORAS

Inox
18/10

Jarra de medidas cónica

Pot mesureur
Messbecher
Measuring cup
Jarra de medidas cónica



Ref.	€	L	U.Venta
67010	30,92	1,00	1



Jarras muy versátiles con un sistema de lectura rápida en mililitros y cups.
Resistentes a los choques térmicos.
100% higiénicas, no transmiten olores ni sabores.

Pichets très versatiles doté d'un système de lecture rapide en millilitres et tasses.
Résistants aux chocs thermiques.
100% hygiénique, ne transmet ni odeurs ni goûts.

Vielseitiger Messbecher mit gut lesbaren Markierungen in Milliliter und Tassen.
Beständig gegen Thermoschocks.
100% hygienisch, überträgt weder Geruch noch Geschmack.

Very versatile jug with easily readable markings in millilitres and cups.
Highly resistant to thermal shock.
100% hygienic. Does not pass on smells or flavours.

Jarras versáteis com sistema de leitura rápida em mililitros em taças.
Resistentes aos choques térmicos.
100% higiénica, não transmite odores nem sabores.

Inox
18/10

Jarra 5 litros

Pot en inox 5 L
Kante 5 L
5 L pitcher
Jarra 5 L



Ref.	€	Ø (cm)	L	U.Venta
62750	65,16	17x22,5	5,00	1



Vidrio borosilicato
Borosilicate glass

100% higiénica
100% hygienic



Vidrio



Jarra medidora

Pot mesureur
Messbecher
Measuring jug
Jarra de medidas

Ref.	€	L	U.Venta
67133	9,44	0,5	1

PP



Jarra medidora

Pot mesureur
Mass Behälter
Measuring jug
Jarra de medidas

Ref.	€	ml	U.Venta
67136	4,25	500	1



Sist. de lectura rápida en mililitros y cups
Easily readable markings in millilitres and cups

PMMA



Jarra medidora SPIN

Pot mesureur
Mass Behälter
Measuring jug
Jarra de medidas

Ref.	€	L	U.Venta
67165	10,06	0,5	1
67161	11,41	1,0	1



SAN



Juego 3 jarras medidoras

Ensemble de 3 pot mesureur
3 tlg. Satz Messbecher
3 piece measuring jugs
Jogo 3 jarras de medidas

Ref.	€	ml	U.Venta
67131	12,97	250-500-1000	1





Caldero semi-estérico sin asas

Bassine hémisphérique s'anses
Schneeschlagkessel ohne Griffe
Semi-spherical mixing bowl w/out/handles
Bacia semi-estérica sem asas

Ref.	€	Ø (cm)	h (cm)	L	U.Venta
50323S	31,13	22	11,0	2,70	1
50327S	36,00	26	13,0	4,00	1
50333S	48,24	32	17,0	9,50	1
50337S	55,30	36	18,0	12,00	1
50341S	92,75	40	21,0	14,50	1



Fuente honda cónica

Bassine pâtisseries
Schüssel, tief, konisch
Deep and conical dish
Bacia alta cônica

Ref.	€	Ø (cm)	h (cm)	L	U.Venta
60013	10,48	13	6,1	0,55	1
60016	11,31	16	9,1	1,00	1
60020	15,67	20	11,7	2,12	1
60024	18,78	24	12,6	3,50	1
60028	23,55	28	13,4	5,25	1
60032	26,15	32	15,0	7,65	1
60036	36,62	36	16,0	11,00	1
60040	42,43	40	18,0	15,00	1



Caldero semi-estérico con asas

Bassine hémisphérique a'anses
Schneeschlagkessel mit Griffe
Semi-spherical mixing bowl w/handles
Bacia semi-estérica com asas

Ref.	€	Ø (cm)	h (cm)	L	U.Venta
50323	40,98	22	11,0	2,70	1
50327	46,17	26	13,0	4,00	1
50333	59,35	32	17,0	9,50	1
50337	63,81	36	18,0	12,00	1
50341	92,13	40	21,0	14,50	1



Caldero cónico con asas

Bassine conique à anses
Wanne mit Griffe
Conical mixing bowl
Bacia cônica con asas

Ref.	€	Ø (cm)	h (cm)	L	U.Venta
50828	36,73	28	13,2	5,00	1
50832	40,36	32	14,5	7,00	1
50836	46,58	36	16,0	11,00	1
50840	51,25	40	18,0	15,00	1
50845	61,84	45	20,0	22,00	1
50850	74,18	50	21,0	30,00	1

Soporte de calderos s/estéricos

Support cul de pouce
Ringständer
Bowl stand
Suporte de bacias semi-estéricas



Ref.	€	U.Venta
50300	22,10	1

Inox



Bolí cónico

Bol conique
Schüssel, konisch
Conical mixing bowl
Bacia cônica

Ref.	€	Ø (cm)	h (cm)	L	U.Venta
14016	3,22	16	6,5	0,90	12
14019	4,46	20	7,5	1,40	12
14025	8,09	24	9,0	2,50	1
14029	10,89	30	11,0	4,30	1
14033	15,15	34	13,5	7,50	1

Inox



Cubo

Seau
Eimer
Pail
Balde

Ref.	€	Ø (cm)	h (cm)	L	U.Venta
14114	7,99	16-12	15,5	1,40	1
14119	15,04	20-15	20,0	4,60	1
14124	18,68	24-17,2	20,5	5,60	1
14128	33,93	28-21	25,8	14,00	1

Cucece especias

Diffuseur épices
Krälerkochsieb
Spice cooker
Cozedor de especiarias



Ref	€	Ø (cm)	h (cm)	U.Venta
62958	10,58	4	15,4	1

Hervidor extensible

Panier marguerite extensible
Kocher, ausdehnbar, Rostfrei
Extensible steamer
Greihã extensivel



Ref	€	Ø (cm)	U.Venta
60349	5,71	24	12
60348	8,40	28	6



Cacerola Vapor

Panier vapeur
Dampkoch-Aussatz o/Untertopf
Steam casserole
Caçarola a vapor



Ref	€	Ø (cm)	h (cm)	U.Venta
50428	50,22	28	11,0	1
50432	55,40	32	12,5	1

Cuscusera

Couscoussier
Kuskustopf
Couscous pot
Couscouseirar



Ref	€	cm	Ø Base	L	U.Venta
50437	81,85	Ø36x16,5	28	15,0	1
50441	92,13	Ø40x22	32	22,0	1

Hervidor pescado

Poissonniere avec grille
Fischkochkessel mit Einsatz
Fish kettle with grill
Peixeira



Ref.	€	cm	h (cm)	L	U.Venta
50440	78,85	40x19	11	10,05	1
50445	86,74	50x17	11	13,80	1
50460	113,40	60x19	11	20,80	1

ESCURRIDORES

Inox
18/10



Escurridor extensible para fregadera

Passoire extensible pour l'évier
Spülbank-Sieb, ausziehbar
Extensible sink strainer

Escurridor extensível para bancada

Ref.	€	cm	Max (cm)	U.Venta
62987	20,44	34x24	55x24	1



Escurridera con base

Passoire sur pied
Abtropfschüssel mit Fussreif
Colander with stand
Escurridora com base

Ref.	€	Ø (cm)	h (cm)	L	U.Venta
50332	185,44	32	18	9,5	1
50336	226,69	36	19	12,0	1
50340	265,60	40	21	14,5	1



Escurridera cónica con base

Passoire conique sur pied
Abtropfschüssel
Conical colander with stand
Escurridor cónico com base

Ref.	€	Ø (cm)	h (cm)	L	U.Venta
50829	59,76	28	17	13,2	1
50833	65,47	32	20	14,5	1
50837	74,60	36	23	16,0	1
50841	80,82	40	26	18,0	1
50846	92,55	45	29	20,0	1
50851	105,31	50	33	22,0	1



Escurridera

Passoire
Abtropfschüssel
Colander
Escurridor



Ref.	€	Ø (cm)	L	U.Venta
14122	15,87	22	3,0	1
14125	19,40	25	5,0	1
14130	28,12	30	8,0	1

Agujeros - Holes : 1x1 cm

Escurrideros

Passoire a friture
Abtropfschüssel für Fritiertes
Fry colander
Escurrido-fritos

Ref.	€	cm	h (cm)	U.Venta
50541	154,48	40x29	8,0	1
50551	182,19	50x39	8,0	1
50561	209,37	60x39	8,0	1



Harinero

Tamis à farine à glissière
Mehlbühler
Flour bin mesh
Farinhiero

Ref.	€	cm	h (cm)	U.Venta
50438	139,96	37x26,5	18	1
50450	144,42	50x26,5	18	1



COLADORES

Mano chino de Haya

Poussoir à chinois en hêtre
Holz-Stößel, Buche
Chinese strainer pusher in beech wood
Pilão p/passador chinês em faia



Ref.	€	L (cm)	U. Venta
60300	5,29	25	1

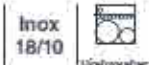

Ideales para colar todo tipo de líquidos (tés, caldos, salsas), alimentos (pasta, arroz, verdura) y hasta tamizar ingredientes.
Disponen de gancho de sujeción.
Aptos para el lavavajillas.

Idéales pour filtrer tout type de liquides (thé, bouillons, sauces) et égoutter toute sorte d'aliments (pâtes, riz, légumes), et même tamiser des ingrédients.
Dispose d'un crochet de fixation.
Aptés pour aller au lave-vaisselle.

Idéales zum Absieben von Flüssigkeiten (Tees, Brühen, Saucen) und Festem (Pasta, Reis, Gemüse) und auch zum Trennen von Zutaten.
Mit Haken zum Aufhängen.
Spülmaschinengeeignet.

Idéales for straining all types of liquids (tees, broths, sauces), food (pasta, rice, vegetables) and even for sifting ingredients.
Complete with hanging hook.
Dishwasher safe.

Idéales para coar todo o tipo de líquidos (chá, caldos, molhos), alimentos (pasta, arroz, verdura) e para peneirar ingredientes.
Com gancho de sujeción.
Aptos para a máquina de lavar louça.

Colador

Passoire
Teigwaren-Einsatz
Colander
Coador



Ref.	€	Ø (cm)	h (cm)	U. Venta
50334	59,86	36	23,0	1
50338	72,42	40	26,0	1



Posibilidad de completar colador en 4 sectores solicitando 4 unidades
Possibility of completing strainer in 4 sectors requesting 4 units

Precio unitario - Unit price:

Colador

Passoire à queue
Seiher mit Stiel
Strainer
Coador



Ref.	€	Ø (cm)	h (cm)	L	U. Venta
50320	47,52	20	12	3,5	1
50324	54,06	24	14	6,5	1
50328	63,39	28	15	9,3	1

Colador chino

Passoire "Chinois"
Spitzsieb mit Flachstiel
"Chinese" strainer
Passador chinês



Ref.	€	Ø (cm)	U. Venta
60311	14,63	10	1
60313	15,04	12	1
60315	15,77	14	1
60317	17,22	16	1
60318	18,26	18	1
60320	19,71	20	1
60322	21,48	22	1
60324	22,51	24	1
60326	24,17	26	1

Colador chino m/varilla c/pestaña

Passoire "Chinois" manche fil
Spitzsieb mit Rundstiel
Wire handle "Chinese" strainer
Passador chinês cabo vareta com suporte



Ref.	€	Ø (cm)	U. Venta
60316P	14,32	16	1
60318P	15,46	18	1
60320P	16,70	20	1
60322P	18,78	22	1
60324P	20,13	24	1

Colador chino mango varilla sin pestaña

Passoire "Chinois" manche fil
Spitzsieb mit Rundstiel
Wire handle "Chinese" strainer
Passador chinês cabo vareta sem suporte



Ref.	€	Ø (cm)	U. Venta
60316V	15,04	16	1
60319V	17,02	20	1

Colador chino de malla

Passoire "Chinois" toile-metallique
Gazespitzsieb
Meshed "Chinese" strainer
Coador chinés de rede



Ref.	€	Ø (cm)	U.Venta
60319	23,86	18	1
60321	29,47	20	1
60323	29,98	22	1
60325	32,99	24	1

Colador malla con refuerzo

Chinois toile-metallique a croisillon
Gewebedurchschlag, konisch, verstäkt
Conical mesh strainer w/protection
Coador de rede com reforço



Ref.	€	Ø (cm)	U.Venta
62621	45,34	20x22	1

Colador cónico

Passoire conique
Passiersieb, konisch
Conical sieve
Coador cónico



Ref.	€	Ø (cm)	U.Venta
62690	6,12	8	1
62611	7,99	10	1
62613	10,17	12	1
62615	12,55	14	1
62617	14,84	16	1
62619	16,91	18	1

Colador 1/2 bola

Passe-bouillon
Passiersieb
Sieve
Coador 1/2



Ref.	€	Ø (cm)	U.Venta
62680	4,57	8	1
62610	7,57	10	1
62612	9,75	12	1
62614	11,21	14	1
62616	13,28	16	1
62618	15,46	18	1
62620	20,13	20	1
62623	24,07	23	1

Colador DRAIN

Passé-bouillon
Passiersieb
Sieve
Coador

Ref.	€	Ø (cm)	U.Venta
62697	4,36	7,5	6
62691	6,64	12,0	6
62698	10,48	18,0	1
62692	12,04	22,0	1



PP
Polipropileno

Inox



Embudo

Entonnoir
Trichter
Funnel
Funil

Ref.	€	Ø (cm)	U.Venta
62512	13,49	12	1
62516	19,51	16	1
62521	26,32	20	1
62524	28,32	24	1



Embudo con filtro

Entonnoir à filtre mobile
Trichter mit Sieb
Funnel with movable filter
Funil com filtro

Ref.	€	Ø (cm)	A (Ø cm)	U.Venta
62531	11,00	10	1,2	1
62513	12,87	12	1,5	1
62515	14,84	14	1,5	1



Triangulo

Triangle
Dreieck
Triangle
Triângulo

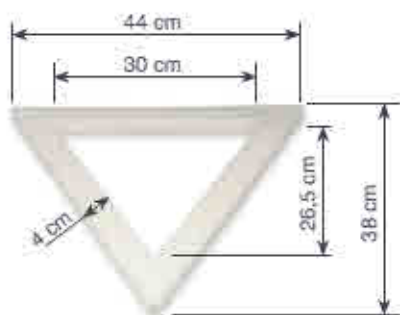

Ref.	€	h (cm)	mm	U.Venta
60402	47,62	2	400	1

SI
Silicone

180°C
max



Embudo Expandible

Entonnoir extensible
Trichter
Foldable funnel
Funil extensível



Ref.	€	Ø (cm)	h (cm)	U.Venta
68085	5,08	8	10,5	1



PASAPURÉS



Inox
18/10



No falta en ninguna cocina.
Utensilio de cocina muy útil y práctico.
Consiguen finos y cremosos purés de hortalizas, frutas y verduras.

Indispensable dans toutes les cuisines.
Ustensile de cuisine très utile et pratique.
Permet d'obtenir de fines et crémeuses purées de légumes et de fruits.

Fehlt in keiner Küche.
Sehr nützliches und praktisches Küchenutensil.
Zur Zubereitung von feinen und cremigen Gemüse- und Obstpürees.

Every kitchen should have it.
Very useful and practical kitchenware.
Achieve fine, creamy fruit and vegetable purées.

Indispensável em qualquer cozinha.
Um utensílio de cozinha útil e prático.
Consigam fins e cremosos purés de hortaliças, frutas e verduras.



Pasapurés Profesional 2 discos
Presse-Purée (2 disques)
Passiergerät (2 Scheiben)
Potato mashing machine 2 discs
Passa-purê profissional 2 discos

Ref.	€	Ø (cm)	L	Ø Disco (cm)	U.Venta
60026	106,86	26	5,0	16,5	1
60031	111,64	32	8,0	16,5	1



Pasapurés 2 discos
Presse-purée (2 disques)
Passiergerät (2 Scheiben)
Potato mashing machine 2 discs
Passa-purê 2 discos

Ref.	€	Ø (cm)	L	Ø Disco (cm)	U.Venta
60030	70,14	30	3,5	16,5	1



Pasapurés 3 discos
Presse-purée (3 disq.)
Passiergerät (3 Scheiben)
Potato mashing machine 3 discs
Passa-purê 3 discos

Ref.	€	Ø (cm)	L	Ø Disco (cm)	U.Venta
60048	47,41	18	0,7	10,5	1
60027	62,36	24	1,5	13,5	1



Pasapurés Doméstico 2 discos
Presse-Purée (2 disques)
Passiergerät (2 Scheiben)
Home Potato mashing machine 2 discs
Passa-purê doméstico 2 discos

Ref.	€	Ø (cm)	L	Ø Disco (cm)	U.Venta
60021	48,04	20	1,5	11,5	1

PREPARACIÓN



Cortador de patatas HASSELBACK

Coupe-pommes de terre Hasselback
Hasselback-Kartoffelschneider
Hasselback potato slicer
Cortador de batatas Hasselback

Ref	€	cm	h (cm)	U.Venta
68180	8,20	18x10	2,1	1



Cortador de verduras y cortador para preparar patatas Hasselback.

Coupe-légumes et coupe-pommes de terre pour préparer des pommes de terre Hasselback

Lässt sich für Gemüse und zum Schneiden von Hasselback-Kartoffeln verwenden
Vegetable slicer and Hasselback potato slicer

Cortador de verduras e cortador para preparar batatas estilo Hasselback



Deshojador de hierbas aromáticas

Efeuillaise à herbes aromatiques
Entblätterer für gewürzkräuter
Aromatic herb stripper
Destalhador de ervas aromáticas

Ref	€	cm	U.Venta
61359	5,60	16,5x7,5x2	1



Utensilio para facilitar la separación de las hojas del tallo y cortarlas. Insertar el tallo en el agujero que mejor se adapte y deslizar la rama en dirección contraria.

Los agujeros pequeños para deshojar hierbas aromáticas como el romero, orégano, tomillo estragón, etc.

Los agujeros más grandes para separar el tallo más duro que tienen algunas verduras de la hoja como las acelgas, espinacas, col rizada, etc.

Gracias a la parte más aguda, se pueden cortar las hojas con el mismo utensilio.

Utensil for easily separating leaves from stalks and cutting them.

Put the stalk into the hole where it fits best and pull the herb in the opposite direction.

The small holes are for stripping leaves from aromatic herbs like rosemary, oregano, thyme, tarragon, etc.

The bigger holes are for separating harder stalks found in some leafy vegetables like chards, spinach, kale, etc.

With the sharp end you can use the same utensil to cut leaves



Aguja de mechar

Aiguille à larder
Spicknadel
Stuffing needle
Aguilha de mechar

Ref	€	L (cm)	U.Venta
61362	4,15	19	6



Su forma puntiaguda y alargada, permite abrir orificios fácilmente en la carne o pescado e insertar tiras de beicon, verduras, frutas, quesos o especias.

Sistema de amarre con doble superficie dentada para una perfecta sujeción. Consigue carnes más sabrosas y pescados más jugosos.

Apta para lavavajillas

Sa forme pointue et allongée permet d'ouvrir facilement des orifices dans la viande ou le poisson et d'y insérer du bacon, des légumes, des fruits, du fromage ou des épices.

Système d'adhérence avec double surface dentée pour une meilleure fixation. Obtenez des viandes plus savoureuses et des poissons plus juteux.

Apte pour le lave-vaisselle.

Its pointed and elongated shape allows easy opening of holes in meat or fish and inserting strips of bacon, vegetables, fruits, cheeses or spices.

Fastening system with double-toothed surface for optimal grips. Get tastier meals and juicier fish.

Dishwasher safe.



Inox
18/10



Prensador de patatas

Presse-purée
Kartoffelpresse
Potato masher
Prensa-patatas

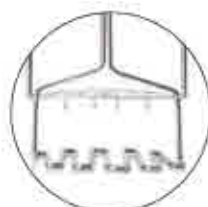

Ref	€	cm	h (cm)	U.Venta
62892	15,70	10,5x8,5	24	1



Inox
18/10



Prensa patatas

Presse-pomme de terre
Kartoffelpresse
Potato press
Esmaga-patatas

Ref	€	cm	U.Venta
62902	29,99	9x28x11	1



Zamak
Zinc
Alloy

Prensa ajos y laminador

Presse ail coupe
Knoblauchpresse, Schneider
Garlic press and slicer
Esmaga-alhos y laminador



Ref	€	L (cm)	U.Venta
60387	22,51	20	1

Inox
18/10



Ablandacarne Inox

Attendrisseur à viande en inox
Fleischklopper, Edelstahl
St. steel meat tenderizer
Ablandacarne inóx



Ref	€	cm	U.Venta
60432	32,37	12x2	1

Inox
18/10



Martillo ablandacarne

Marteau attendrisseur de viande
Fleischklopper Hammer
Meat hammer tenderizer
Martelo ablandador de carne



Ref	€	cm	U.Venta
60431	14,53	7x24	1



Inox
18/10



Molde empanadillas

Moule à chaussons
Pastelenformen
Dumpling mould
Forma para salgados



Ref	€	Ø (cm)	U.Venta
68101	17,95	10	1
68102	19,71	12	1

PICADORAS

Picador de cebolla

Hachoir-oignon
Zwiebelhacker
Onion chopper
Picador de cebolla

Ref	€	Ø (cm)	h (cm)	U.Venta
62980	27,39	9,5	22	6



Inox
18/10



Ideal para ajos, cebolla o verduras.
Al presionar el mango, las cuchillas giran, picando los alimentos de forma segura y rápida.
Los alimentos picados quedan en el mismo recipiente.
Fácil de limpiar.

Idéal pour l'ail, oignons ou des légumes.
En appuyant sur le manche, les lames tournent, hachant ainsi les aliments de façon sécurisée et rapide.
Les aliments émincés restent dans le récipient.
Facile à nettoyer.

Idéal für Knoblauchzehen, Zwiebeln und Gemüse zerkleinern.
Per Druck auf den Knopf drehen sich die Klingen und zerkleinern dabei die Lebensmittel sicher und schnell.
Die zerkleinerten Lebensmittel bleiben im gleichen Behälter.
Leichte Reinigung.

Perfect for garlic, onions or vegetables.
The blades spin when you squeeze the handle and the food is chopped safely and quickly.
The chopped food stays in the container.
Easy to clean.

Picaperejil

Hachoir à manivelle pour fines herbes
Kräutermühle, fein, Rostfrei
St. steel fine herbs mincer
Pica-salsa

Ref	€	cm	U.Venta
60334	19,19	13,5x20x7,5	1



Idéal para alhos, cebolla e verduras.
As lâminas giram ao pressionar o mango, picando os alimentos de forma segura e rápida.
Os alimentos picados armazenam-se no recipiente.
Fácil de limpar.

Rallador Inox 2 cuchillas

Hachoir en Inox 2 lames
Käsereiber, 2 Schneiden, Rostfrei
St. steel cheese grater (2 blades)
Rallador Inóx com manivela com 2 lâminas

Ref	€	cm	U.Venta
60335	29,67	13,5x20x10	1



Inox

Picadora de carne manual

Hachoir avec manivelle
Fleischwolf mit handkurbel
Meat mincer
Picadora de carne manual

Ref	€	cm	U.Venta
60329	106,45	17x12x19	1



Picadora

Mincer
Fleischwolf
Hachoir
Picadora

Ref	€	cm	U.Venta
60340	29,78	18x22	1



► MORTEROS

PE

Polyethers

Mortero

Mortier
Mörser
Mortar
Almotariz



Ref.	€	Ø (cm)	U.Venta
60403	138,20	18	1



Granito de calidad PREMIUM
PREMIUM quality granite



Fabricados en granito de calidad Premium.
Interior no poroso, permite extraer los aceites naturales de las hierbas y especias.

Composé de granit de qualité supérieure.
Intérieur non poreux permettant d'extraire les huiles essentielles des herbes et épices.

Aus Granit der Premium Qualität gefertigt.
Nicht poröse Innenseite ermöglicht die Extraktion von natürlichen Ölen aus Kräutern und Gewürzen.

Manufactured from Premium quality granite.
Interior no porous allowing extracting natural oils from herbs and spices.

Fabricado em granito de qualidade Premium.
Interior não poroso permitindo extrair os óleos naturais das ervas e especiarias.

PE

Polyethers

Mano mortero

Poussoir à mortier
Stößel
Pestle
Pilão p/almotariz



Ref.	€	Ø (cm)	U.Venta
60401	33,72	Ø4,8x25	1

Mortero con mano de granito

Mortier et pilon en granit
Mörser und Stößel aus Granit
Granite mortar and pestles
Argamassa e pilão do granito

	Ref.	€	Ø (cm)	h (cm)	ml	U.Venta
A	60512	22,20	12	8	250	1
	60514	25,94	14	10	375	1
B	60516	26,98	16	12	600	1



Mortero con mano de granito

Mortier et pilon en granit
Mörser und Stößel aus Granit
Granite mortar and pestles
Argamassa e pilão do granito

	Ref.	€	Ø (cm)	h (cm)	ml	U.Venta
A	60517	21,48	10,5	7,5	225	1
B	60518	21,89	12	12,0	365	1



▶ EXPRIMIDORES

Inox

Exprimidor manual

Presse citron manuel
Manuelle Zitronenpresse
Manual lemon reamer
Espremedor manual



Ref	€	Ø (cm)	L	U.Venta
62952	15,15	10	0,15	6
62912	17,64	12	0,20	6

Tres salidas vertedoras. Medidor en mililitros y cups

Three pouring outlets. Measurements in milliliters and cups.



Mini exprimidor

Mini presse-citron
Minizitruspresse
Mini squeezer
Mini espremedor

Ref	€	cm	h (cm)	ml	U.Venta
68181	5,50	10x9,5	8,5	70	1

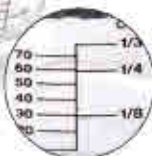

Exprimidor Limón

Presse-citron
Zitruspresse
Lemon squeezer
Espremedor de limão



Ref	€	U.Venta
62946	10,06	1

Exprimidor

Presse-fruits
Zitruspresse
Citrus press
Espremedor



Ref	€	Ø (cm)	h (cm)	U.Venta
63912	10,89	4,5	16	1

AL

Aluminium

Exprimidor manual

Presse citron manuel
Manuelle Zitronenpresse
Manual lemon reamer
Espremedor manual



3 en 1
3 in 1

Ref	€	L (cm)	U.Venta
63915	9,66	22	1

Inox
18/10



Ideales para limas, limones, naranjas e incluso pomelos.
Extraen el jugo sin cascara, pulpa y semillas.
Disfruta del zumo recién exprimido.

Ideales pour les citrons verts, les citrons jaunes, les oranges, et même les pamplemousses.

Extrait le jus sans peau, pulpe ou graines.
Dégustez un jus fraîchement pressé.

Idealt für Limetten, Zitronen, Orangen und sogar Grapefruit.
Entsaftet ohne Schale, Fruchtfleisch und Kerne.
Genießen Sie frisch gepressten Saft.

Ideals for limes, lemons, oranges and even grapefruit.
Extracts the juice without peel, pulp and seeds.
Enjoy freshly squeezed juice.

Ideales para limas, limões, laranjas e pomelos.
Extra o sumo sem cascas, polpa ou sementes.
Desfrute do suco espremido na hora.



Exprimidor de zumo bajo

Presse-fruits manuel
Manuelle fruchtpresse, klein
Manual squeezer low
Espremedor de sumos baixo

Ref	€	cm	h (cm)	U.Venta
63913	49,70	21x18	21	1



Exprimidor de zumo alto

Presse-fruits manuel grand
Manuelle fruchtpresse, hoch
Manual squeezer high
Espremedor de sumos alto

Ref	€	cm	h (cm)	U.Venta
63914	45,75	15x19	39	1

▶ MÁQUINA LAMINADORA PASTA



Regulador de grosor de pasta (3,4 mm - 0,93 mm)
Pasta thickness Regulator (3,4 mm - 0,93 mm)



Máquina laminadora pasta
Machine Lamineuse à pâte
Pastamaschine
Pasta Machine Slicer
Maquina de Pasta

	Ref	€	mm	U.Venta
A	60390	39,11	145	1
B	60391	72,11	260	1



Disfruta cocinando tu propia pasta fresca.
Rodillos de acero inoxidable, permiten conseguir hasta 9 grosores de pasta.
Posibilidad del accesorio para Raviolis.

Cuisinez vos propres pâtes fraîches.
Rouleaux en acier inoxydable, qui permettent d'obtenir jusqu'à 9 épaisseurs de pâtes.
Possibilité d'ajouter l'accessoire pour raviolis.

Nudeln problemlos selber machen.
Edelstahlwäzeln mit 9 verschiedenen Stärken für Ihre Nudeln.
Mit Ravioli-Aufsatz erhältlich.

Enjoy cooking your own fresh pasta.
Stainless steel rollers with 9 different thickness settings allowing you to make different varieties of pasta.
Additional accessory for making ravioli.

Desfrute cozinhando a sua própria massa fresca.
Rolos de aço inoxidável, para elaborar até 9 espessuras diferentes de massas.
Possibilidade de utilização de acessório para elaborar raviolis.

Amplia las recetas con el accesorio para ravioli
Expand recipes with ravioli accessory



Accesorio para Ravioli

Accessoire pour Raviolis
Zubehör für Ravioli
Ravioli maker
Acessório para Raviolis

	Ref	€	Columnas	Ravioli	U.Venta
A	60497	18,78	2	45x45 mm	1
B	60498	18,78	3	30x30 mm	1

Solo puede utilizarse en la máquina de 145 mm (Ref: 60390)
Only can be used in the machine of 145 mm (Ref: 60390)



Inox
18/10

Medidor de pasta Inox

Mesureur pour pâtes en Inox
Spaghetti-Mass Fostfrei
St steel pasta measurer
Medidor para macarrao en Inox

	Ref	€	cm	U.Venta
A	62942	2,91	18	1
B	62943	3,94	11x9	1



▶ EMBUTIDORA MANUAL



Incluye boquillas
Includes nozzles

Ø38 mm Ø32 mm Ø22 mm Ø16 mm



Embutidora manual

Poussoir manuel

Manuelle Würstfüller

Manual stuffer

Máquina para encher salsichas manual

Ref.	€	L.	Cilindro (cm)	U.Venta
60253	233,16	3	Ø14 x 20	1
60255	264,98	5	Ø14 x 32	1

Inox
18/10

Fabricada en acero inoxidable de gran calidad.

Permite producir diferentes tipos de embutidos como chorizos, butifarras, salchichas, etc.

Gran capacidad, ideal para carnicerías, restaurantes y cocinas industriales.

Produce los embutidos de forma rápida y eficiente.

Incluye 4 boquillas de llenado de Ø16, 22, 32 y 38 mm.

Tuerca de unión de fácil manejo que permite cambiar rápidamente las boquillas de llenado.

Cuenta con dos velocidades (lenta / rápida) gracias a un mecanismo de dos marchas accionado por rodamiento.

El contenedor es inclinable a 90 grados para facilitar el llenado y limpieza.

Fabriquée en acier inoxydable de grande qualité

Permet de produire différents types de saucisses comme les chorizos, les saucisses catalanes, les saucisses classiques, etc.

Grande capacité, idéal pour les boucheries, les restaurants et les cuisines industrielles.

Produit des saucisses de façon rapide et efficace

Inclut 4 tuyaux de remplissage de Ø16, 22, 32 et 38 mm.

Vis d'assemblage facile à utiliser qui permet de changer rapidement les tuyaux de remplissage.

Dispose de deux vitesses (lent / rapide) grâce à un mécanisme à deux vitesses actionné par roulement.

Le conteneur est inclinable à 90 degrés pour faciliter le remplissage et le nettoyage

Aus hochwertigem Edelstahl

Für Paprikawurst, Presswurst, Frankfurter und andere Würstarten geeignet

Große Leistung, ideal für Metzgereien, Restaurants und Großküchen

Arbeitet schnell und effizient

Mit 4 Füllaufsätzen Ø 16, 22, 32 und 38 mm

Anwenderfreundliche Schraubverbindung erleichtert den schnellen Wechsel der Aufsätze

Radlagerantrieb mit zwei Geschwindigkeiten (schnell/langsam)

90 Grad Neigebehälter für leichte Füllung und Reinigung

Made of high quality stainless steel

Can be used to make different kinds of sausages, like chorizo or butifarra

High capacity, perfect for butcher shops, restaurants and industrial kitchens

Makes sausages quickly and efficiently

Includes four 16, 22, 32 and 38 mm diameter filling tubes

The easy to use bolt makes it easy to change the filling tubes quickly

It has 2 speeds (slow/fast) because of its two gear bearing driven mechanism

The container can be tilted 90° for easy filling and cleaning

Fabricada em aço inoxidável de grande qualidade

Permite produzir diferentes tipos de enchidos, comoouriços, mortilhas, salchichas, etc

Grande capacidade, ideal para lathos, restaurantes e cozinhas industriais

Produz enchidos de forma rápida e eficiente

Inclui 4 tubos de enchimento de Ø16, 22, 32 e 38 mm

Porca de união de fácil manejo, tua permite mudar rapidamente os tubos de enchimento

Mecanismo de duas velocidades (lenta/rápida) acionado por rolamento

O recipiente pode inclinar-se até 90° para facilitar o enchimento e a limpeza



Cambio rápido de boquillas
Quick tube change



Dos velocidades
Two speed



Contenedor inclinable 90°
90° tiltable container

▶ CONTENEDOR

Ideal para especias y condimentos
Ideal for spices and condiments



Contenedor alimentos con tapa

Boîte à condiments avec couvercle
Gewürzkasten mit Deckel
Condiments holder with lid
Caixa condimentos com tampa

	Ref	€	cm	Cavidades	Unidad (ml)	U.Venta
A	61133	23,76	50x16x9	3	1000	1
B	61134	23,76	50x16x9	4	750	1
C	61135	23,76	50x16x9	5	600	1
D	61136	23,76	50x16x9	6	450	1

▶ PIPETAS · JERINGA



Pipeta para salsa

Poire à jus
Sossenspritze
Sauce syringe
Pipeta para molho

Ref	€	L (cm)	ml	U.Venta
61416	11,00	30	40	1



Inyecta salsas o especias.
Extrae la salsa para reducirla en la sartén.

Injecter des sauces ou des épices.
Extraire du plat afin de les réduire dans une poêle à feu vif

Spritze zum Einspritzen von Saucen und Gewürzen.
Extrahieren von Saucen um Sie in der Pfanne zu reduzieren.

Syringe to inject sauces or spices.
Extract them to separately reduce them in a frying pan.

Injetar molhos ou especiarias.
Extrair os molhos para reduzi-los numa frigideira a lume vivo.



Inox

Pipeta para salsa

Poire à jus
Sossenspritze
Sauce syringe
Pipeta para molho

Ref	€	L (cm)	ml	U.Venta
61408	15,15	30	40	1



Jeringa para cocina

Seringue pour cuisine
Spritze Küche
Kitchen syringe
Seringa para cozinha

Ref	€	ml	Unidades	U.Venta
61418	5,19	30	ml-oz-tsp-Tbsp	6



BOTELLAS BIBERÓN

Botella biberón
Bouteille biberon
Dosierflasche
Squeeze bottle
Garrafa



Ref	€	Ø (cm)	L	U.Venta
61912	1,30	4x10	0,12	12
61925	1,35	5x19	0,25	12
61940	1,40	5,5x21,5	0,40	12
61970	1,71	7x26	0,70	12

Ideal para Ketchup
Ideal for Ketchup



Botella biberón
Bouteille biberon
Dosierflasche
Squeeze bottle
Garrafa

Ref	€	Ø (cm)	L	U.Venta
61925R	1,35	5x19	0,25	12
61940R	1,45	5,5x21,5	0,40	12
61970R	1,76	7x26	0,70	12

Ideal para Mostaza
Ideal for mustard



Botella biberón
Bouteille biberon
Dosierflasche
Squeeze bottle
Garrafa

Ref	€	Ø (cm)	L	U.Venta
61925A	1,35	5x19	0,25	12
61940A	1,45	5,5x21,5	0,40	12
61970A	1,76	7x26	0,70	12

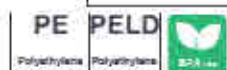

Ideales para salsas, cremas, aceites, aliños, vinagretas y todo tipo de condimentos líquidos.
Dibuja, adorna y personaliza con estilo tus platos, creando un efecto visual y gastronómico muy atractivo.

Uso muy sencillo, cuentan con un tapón de rosca para poder introducir el aliño.

Idéal pour les sauces, les crèmes, les huiles, les assaisonnements, les vinaigrettes et tout type de condiments liquides.

Il dessine, décore et personnalise les plats avec style en créant un effet visuel et gastronomique très attrayant.

Utilisation très simple dispose d'un bouchon à vis pour pouvoir introduire l'assaisonnement.

Ideal für Saßen, Cremes, Öle, Dressings, Vinaigretten und alle möglichen flüssigen Gewürze.

Verschönern und verzieren Sie Ihre Gerichte und geben Sie ihnen Ihren persönlichen Touch, indem Sie einen äußerst attraktiven visuellen und gastronomischen Effekt erzeugen.

Sehr-einfache Handhabung mit Schraubverschluss, um das Gewürz einzufüllen.

Ideal for sauces, creams, oils, dressings, vinaigrettes and all kinds of liquid condiments.
Draw, decorate and personalize your dishes with style, creating a very attractive visual and gastronomic effect.

Very simple to use, it features a screw cap for pouring in the dressing.

Ideias para molhos, cremas, óleos e azetias, temperos, vinagretas e todo o tipo de condimentos líquidos.
Desenhe, decore e personalize com estilo os seus pratos, criando um efeito visual e gastronómico espetacular.

Fácil de utilizar, com tampo de rosca para introduzir o tempero.



2 en 1
2 in 1



Biberón decoración

Biberon à décorer
Dekorieren dosierflasche
Decorating pen
Garrafa decoração

Ref	€	Ø (cm)	ml	U.Venta
64458	7,99	5x17,5	150	6

Botella biberón con boquilla triple

Bouteille biberon avec douille triple
Dosierflasche mit Dreifachdüse
Squeeze bottle with triple nozzle
Garrafa com boquilha triplo



Ref	€	Ø (cm)	ml	U.Venta
61974	3,22	7x20	472	6
61977	3,42	7x26	708	6



Biberón decoración

Biberon à décorer
Dekorierflasche
Decorating pen
Garrafa decoração

Ref	€	Ø (cm)	ml	U.Venta
64457	7,78	5,5x16	140	1



SIFONES

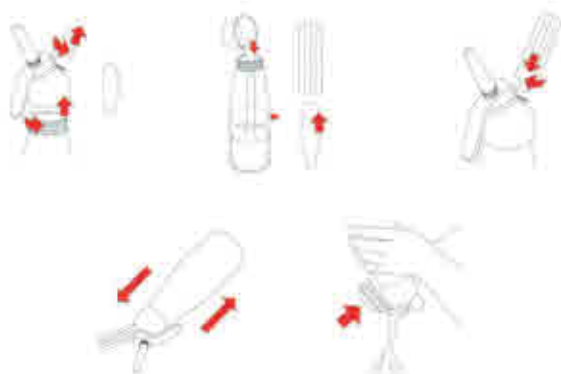

APTO SOLAMENTE PARA MEZCLAS FRIAS Y TEMPLADAS (<40°C)
À UTILISER UNIQUEMENT POUR LES MÉLANGES FROIDS ET TREMPÉS (<40°C)
ONLY SUITABLE FOR COLD AND TEMPERED MIXTURES (<40°C)



Cargas sifón N₂O

Cartouches N₂O pour siphon
 N₂O Kapsel für Sahnebereiter
 N₂O cream charger
 Botijas de sifão N₂O



EXCLUSIVAMENTE PARA USO ALIMENTICIO
EXCLUSIVELY FOR FOOD USE

Ref	€	Botellas	g	U.Venta
68402	7,15	10	8	1
68403	16,70	24	8	1

Cabezal - Head: **Aluminio** / Aluminium
Botella - Bottle: **Inox**

Sifón crema

Siphon à crème
 Sahnebereiter
 Cream whipper
 Sifão creme

Ref	€	Ø (cm)	L	U.Venta
68404	103,23	7,8x25	0,50	1
68405	118,48	9,3x32,5	1,00	1

Temperatura de uso - Use temperature
 min = +5°C / max = +40°C



Realice en segundos purés, mousses, cremas montadas, espumas, salsas y deliciosos postres, un toque de elegancia en la cocina.

Ofrece 4 veces más volumen que el volumen líquido.

NO debe ser empleado con líquidos calientes. NUNCA ponga los sifones al baño maría, puede producirse una explosión con graves consecuencias.

Réalisez en quelques secondes des purées, des mousses, des crèmes montées, des sauces et de délicieux desserts, une touche d'élegance dans la cuisine. Confère 4 fois plus de volume à que le volume liquide.

NE DOIT PAS être utilisé avec des liquides chauds. **NE JAMAIS** mettre les siphons au bain maría car une explosion pourrait avoir lieu et provoquer de graves conséquences.

Pürees, Mousses, Schlagsahne, Schäume, Saucen und köstliche Desserts im Nu zubereiten, ein Hauch von Eleganz in der Küche. Vervielfacht das Ausgangsvolumen der Flüssigkeit.

NICHT für Verwendung mit heißen Flüssigkeiten geeignet. Gern: **NIEMALS** ins Wasserbad legen. Dies kann zu einer folgenschweren Explosion führen.

Make purées, mousses, whipped creams, foams, sauces and delicious desserts in seconds. A touch of elegance in the kitchen. Whips content up to 4 times the liquid volume.

Should **NOT** be used with hot liquids. **NEVER** put siphons in a water bath, as this may cause an explosion with serious consequences.

Prepare em segundos purés, mousses, cremas batidas, espumas, molhos e deliciosos sobremesas, dando um toque de elegância à sua cozinha. Proporciona 4 vezes mais volume do que o volume líquido.

NÃO utilizar com líquidos quentes. **NUNCA** coloque os sifões em banho-maria, para evitar o risco de explosão com consequências graves.

Cabezal - Head: **Plástico PBT** / PBT plastic
Botella - Bottle: **Aluminio** / Aluminium

Sifón crema

Siphon à crème
 Sahnebereiter
 Cream whipper
 Sifão creme

Ref	€	Ø (cm)	L	U.Venta
68502	35,59	9x27	0,25	1
68500	42,23	9x31	0,50	1
68501	47,00	11x36	1,00	1

Temperatura de uso - Use temperature
 min = +5°C / max = +40°C



Cabezal - Head: **Aluminio** / Aluminium
Botella - Bottle: **Aluminio** / Aluminium

Sifón GREEN

Siphon à crème
 Sahnebereiter
 Cream whipper
 Sifão creme

Ref	€	Ø (cm)	L	U.Venta
68504	44,51	7,8x27,3	0,50	1
68505	48,97	9,3x32,5	1,00	1

Temperatura de uso - Use temperature
 min = +5°C / max = +40°C



Cabezal - Head: **Aluminio** / Aluminium
Botella - Bottle: **Aluminio** / Aluminium

Sifón BLACK

Siphon à crème
 Sahnebereiter
 Cream whipper
 Sifão creme

Ref	€	Ø (cm)	L	U.Venta
68604	44,51	7,8x27,3	0,50	1
68605	48,97	9,3x32,5	1,00	1

Temperatura de uso - Use temperature
 min = +5°C / max = +40°C



DOSIFICADORES

Salado
Dâtéed



Dulce
Sweet



Diseño premiado en certámenes internacionales
International award-winning flow
Good Design 2003 International Industrial
Graphic Design Competition The Chicago Athenaeum

Ideal para rellenar, verter y decorar
Ideal for filling, pouring and decorating



Dosificador
Entonnoir à décor
Dosierer
Portionner
Dosificador

Ref.	€	L.	U.Venta
67000	75.43	2,00	1

Inox 18/10 ASA Acrylic BPA free Utensilware

Cono de acero inoxidable 18/10, excelente resistencia a la corrosión, los ácidos alimentarios y sales. Capacidad 2 L.
Soporte mango con sistema de gatillo para un caudal ajustable.
Base con mucha estabilidad. Fácil desmontaje para una cómoda y sencilla limpieza.
Contiene una válvula y 3 boquillas para que las cremas y salsas fluyan en menor o mayor cantidad tanto calientes como frías.

Cône en acier inoxydable 18/10, excellente résistance à la corrosion ainsi qu'aux acides et sels alimentaires. Capacité 2 L.
Support manche avec système de gâchette pour un débit ajustable.
Base d'une très grande stabilité et facile à démonter pour un nettoyage simple et pratique.
Contient une valve et 3 emboucs pour que les crèmes et les sauces, aussi bien chaudes que froides, coulent en quantité plus ou moins importante.

Konus aus Edelstahl 18/10, besonders widerstandsfähig gegen Korrosion, Lebensmittel Säuren und Salze. Kapazität 2 L.
Griff mit Abzug für einen regulierbaren Durchflussmesser.
Stabile und einfach auseinandernehmbare Befestigung für eine bequeme und einfache Reinigung.
Bainhalte ein Ventil und 3 Tüllen, damit Cremes und Saucen, sowohl kalte als auch warme, in kleinerer oder größerer Menge fließen.

18/10 stainless steel cone, excellent resistance to corrosion, food acids and salts. 2 litre capacity.
Support handle with trigger system for an adjustable flow.
Base offers great stability and easy disassembly for convenient and easy cleaning.
Contains a valve and 3 nozzles so that hot and cold creams and sauces flow in greater or lesser quantities.

Cone em aço inoxidável 18/10, com excelente resistência à corrosão, aos ácidos alimentares e aos sais. Capacidade para 2 litros.
Suporte com mango com sistema de gatilho, para um caudal ajustável.
Base com grande estabilidade e fácil de desmontar, para uma limpeza fácil e cómoda.
Contém uma válvula e 3 boquilhas para dosar com precisão a quantidade de cremes e molhos, quentes ou frios.

Cono Inox 18/10

Cône
Trichter
Cone
Cone Inox 18/10

Ref.	€	L.	U.Venta
R67000	33.51	2,00	1



Soporte mango

Support
Stütze
Support
Suporte cabo

Ref.	€	U.Venta
R67001	30.19	1



Base negra

Base noire
Ständer, schwarz
Black base
Base negra

Ref.	€	U.Venta
R67002	11.83	1



Boquillas

Douille
Düse
Nozzle
Boquilhas

	Ref.	€	Ø (mm)	U.Venta
A	R67003	1.35	1	1
B	R67004	1.56	4	1
C	R67005	1.56	6	1
D	R67006	1.56	8	1





Ideal para rellenar, verter y decorar
Perfect for filling, pouring and decorating

Ideal para rellenar o decorar platos con salsas y cremas calientes y frías.
Sistema de palanca para un caudal ajustable; práctico y preciso.
Sistema antigoteo y salpicaduras.
Mango con diseño ergonómico que permite el manejo con una sola mano.
Fácil desmontaje para una sencilla limpieza. Apto para el lavavajillas.
Ref.: 67150: Contiene 3 boquillas de distintos diámetros (4, 6 y 8 mm) para que las cremas y salsas fluyan de la forma deseada, en menor o mayor cantidad.

Idéal pour remplir ou décorer des assiettes avec des sauces chaudes et froides.
Système de piston pour un débit ajustable; pratique et précis.
Système anti-goutte et anti-éclaboussures.
Manche ergonomique qui permet de le manipuler d'une seule main.
Facile à démonter pour un nettoyage aisé, et apte pour le lave-vaisselle.
Ref.: 67150: Contient 3 embouts de différents diamètres (4, 6 et 8 mm) pour que les crèmes et les sauces coulent de la façon souhaitée, en plus ou moins grande quantité.

Er eignet sich ideal zum Anrichten oder Servieren von Saucen und Cremes, gleich ob kalt oder warm.
Das Hebelsystem ermöglicht einen dosierten, bequemen und genauen Ausschank.
Antiropf- und Antispritzsystem.
Ergonomischer Griff für Einhandbedienung.
Zum Reinigen einfach auseinandernehmbar und spülmaschinengeeignet.
3 Aufsätze im Durchmesser von 4, 6 und 8 Millimeter für einen Ausschank von Saucen und Cremes genau nach Bedarf!

Perfect for filling or decorating dishes with hot or cold sauces and cream.
Its lever system for controlling the flow is practical and precise.
Anti-drip and anti-splash system.
The ergonomic handle means it can be used with just one hand.
It's easy to disassemble for easy cleaning and it's dishwasher safe.
Ref.: 67150: Includes 3 nozzles with different diameters (4, 6 and 8 mm) so cream or sauce can flow just how you want, at a higher or lower quantity.

Idéal para decorar platos e dispensar molhos e cremas, quentes ou frios.
Caudal ajustável mediante sistema de alavanca, práctico e preciso.
Sistema anti-gotejamento e salpicaduras.
Mango com desenho ergonómico, que permite a manipulação com uma só mão.
Fácil de desmontar para a sua limpeza. Apto para máquinas de lavar louça.
Ref.: 67150: Inclui 3 bocanilhas de diferentes diâmetros (4, 6 e 8 mm), que asseguram um fluxo adequado dos cremes e molhos, em menor ou maior quantidade.



Incluye soporte
Includes support

Incluye un platillo anti-goteo
Includes a drip dish

Inox 18/10
Dishwasher

Dosificador
Entonnoir à décor
Dosierer
Portionner
Dosificador

Ref.	€	Ø (cm)	h (cm)	L	U.Venta
67150	49,70	19	27	2,0	1
8671508	16,08	4/6/8			1

Set 3 boquillas
Set 3 nozzles

New

Marcas de medición en el contenedor (ml - Cup)
Measuring marks on the container (ml - Cup)

PS Polystyrene
SI Silicone
BPA Free
Dishwasher

Dispensador de repostería
Distributeur de pâtisserie
Tölkensatzspender
Batter dispenser
Distribuidor de pastelería

Ref.	€	L	cm	h (cm)	U.Venta
67026	10,17	1,00	16x11	18	1



▶ AHUMADORES



Técnica popular de la cocina creativa, otorga a los platos aromas especiales y personalizados.

Perfecto para ahumar todo tipo de alimentos (carnes, pescados, quesos...).

La construcción y su diseño facilitan la limpieza y el mantenimiento.

Ideal para presentar y terminar platos delante del cliente.

Incluye un set de filtros de recambio.

Fácil de transportar gracias a su forma y tamaño.

Pilas no incluidas.

*Compatible con nuestras campanas de ahumado (Ref. 61813, 61816, 61815, 61817) y la tapa (Ref.: 69554).

Technique populaire de la cuisine créative, qui confère aux plats des arômes spéciaux et personnalisés.

Parfait pour fumer tout type d'aliments (viandes, poissons, fromages...).

La fabrication et la conception de chacune de ses parties facilite son nettoyage et son entretien.

Ideal pour présenter et apporter la touche finale à des plats devant le client.

Inclut un set de filtres de rechange.

Facile à transporter grâce à sa forme et sa taille.

Piles non incluses.

*Compatible avec nos cloches de fumage (réf. 61813, 61815, 61816, 61817) et le couvercle (Réf. 69554).

Beleebtes und kreatives Verfahren, das Speisen ein spezielles und individuelles Aroma verleiht.

Ideal geeignet, möglichen Lebensmittel (Fleisch, Fisch, Käse usw.) zu räuchern. Die Teile sind so konstruiert und geformt, dass sie leicht gereinigt und gepflegt werden können.

Ideal dazu geeignet, Gerichte vor dem Gast anzuzüchten und zu präsentieren. Inkl. Ersatzfiltern.

Handliche Form und Größe.

Batterien nicht im Lieferumfang enthalten.

*Kompatibel mit unseren Räucherglocken (Art. Nr. 61813, 61815, 61816, 61817), und der Deckel (Ref.: 69554).

A popular creative cooking technique which gives dishes special and personalised aromas.

Perfect for smoking all kinds of foods (meat, fish, cheeses...)

The way it is designed and constructed makes it easy to clean and maintain.

Ideal for presenting and finishing dishes in front of the customer.

Includes a set of replacement filters.

Easy to transport thanks to its shape and size.

Batteries not included.

*Compatible with our smoking cloches (ref. 61813, 61815, 61816, 61817) and the lid (Ref.: 69554).



69221 - 69321

Incluyen bolsa de serrín (100 g)

Wood Chips bag included (100 g)

Olivo - Olive



Ahumador de alimentos

Fumoir pour aliments

Apparat zum Räuchern von Lebensmitteln

Food smoker

Defumador de alimentos

	Ref.	€	U. Venta	
A	69221	40,98	1	MAGIC
B	69321	55,09	1	INSTANT

Técnica popular de cozinha criativa, proporciona aos pratos aromas especiais e personalizados.

Perfeito para defumar todo o tipo de alimentos (carnes, peixes, queijos...).

A construção e o design dos seus componentes facilitam a sua limpeza e manutenção.

Ideal para apresentar e terminar pratos na presença do cliente.

Inclui um conjunto de filtros de reposição.

Fácil de transportar graças à sua forma e dimensões.

Pilhas não incluídas.

*Compatível com as nossas câmaras para defumar (ref. 61813, 61815, 61816, 61817) e a lanterna (Ref.: 69554).



CAMPANAS

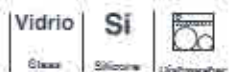
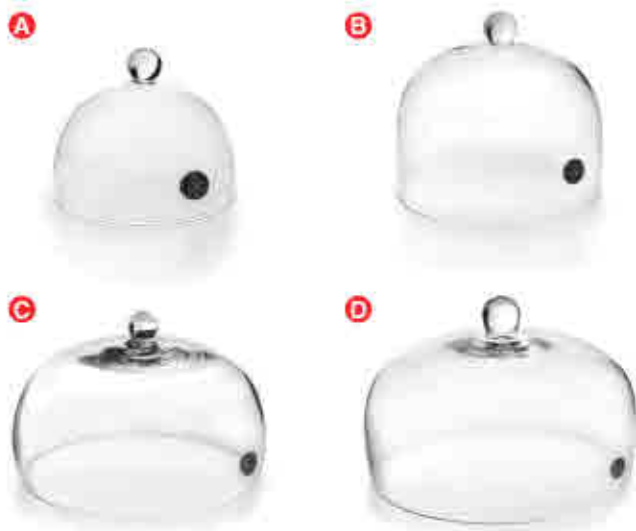

Campana ahumador

Cloche à fumer
Räucherglocke
Smoker Hood
Campânula defumadora

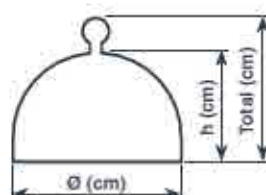

	Ref	€	Ø (cm)	h (cm)	Total (cm)	U.Venta
A	61813	11,21	12,5	7,5	11	1
B	61815	18,47	16,0	12,0	15	1
C	61816	20,44	20,0	12,0	15	1
D	61817	34,86	25,0	14,0	17	1



Campana que permite la entrada de humo, vapor y aromas para ahumar o aromatizar alimentos sin tener que levantarla.
Fabricada en vidrio borosilicato de gran calidad y resistente a golpes, altas y bajas temperaturas.
Se puede introducir en el microondas, horno y congelador.
Válvula de inyección con auto cierre de silicona (200°C).
Complemento ideal para nuestro ahumador.

Cloche qui permet l'entrée de fumée, de vapeur et d'arômes pour fumer ou aromatiser les aliments sans avoir à la soulever.
Fabriquée en verre borosilicaté de grande qualité et résistante aux chocs ainsi qu'aux basses et hautes températures.
Peut être mise au micro-ondes, au four ou au congélateur.
Valve d'injection avec auto-fermeture en silicone (200°C).
Complément idéal pour notre fumeur.

Die Glocke lässt Rauch, Dampf und Aromen einströmen, um darin befindliche Lebensmittel zu räuchern oder zu aromatisieren.
Aus qualitativ hochwertigem Borosilikatglas, schlagfest und temperaturbeständig.
Geeignet für Mikrowelle, Backofen oder Gefrierfach.
Selbstschließende Injektionsklappe aus Silikon (200°C).
Ideales Zubehör für unseren Räucherapparat.

Cooker hood that lets smoke, steam and aromas inside for smoking or flavouring food without having to lift it up.
Made of high quality impact resistant borosilicate glass that can withstand high and low temperatures.
Microwave, oven and freezer safe.
Injection valve with silicone self closure (200°C).
A perfect addition for our smoker.

Campânula que permite a entrada de fumo, vapor e aromas para defumar ou aromatizar alimentos sem ter que levantar a tampa.
Fabricada em vidro de borossilicato de grande qualidade, e resistente aos golpes, e a altas e baixas temperaturas.
Pode introduzir-se no micro-ondas, no forno ou no congelador.
Válvula de injeção com fecho automático de silicone (200 °C).
Complemento ideal para o nosso defumador.

TAPA CÓCTEL



Tapa para ahumar

Chapeau de fumée
Rauchdeckel
Smoke cap
Tampa de fumaça



	Ref	€	Ø (cm)	U.Venta
	69554	3,63	12	1

Tapa en forma de CD para crear un efecto hermético al momento de ahumar.
Válido para todo tipo de envases, vasos, cocteleros, tarros, etc.
Ideal para ahumar cócteles, destilados, comidas, quesos, etc.
Válvula de inyección con auto cierre de silicona (200°C).

Couvercle en forme de CD pour créer un effet hermétique lors du fumage.
Apté pour tout type de contenants, verres, shakers, pots, etc.
Idéal pour fumer des cocktails, des alcools distillés, des plats, des fromages, etc.
Valve à injection avec fermeture automatique en silicone (200°C).

CD-förmiger Deckel zum luftdichten Verschluss beim Räuchern.
Geeignet für Gefäße, Gläser, Mixbecher, Einmachgläser und alle Arten von Behältern.
Ideal zum Räuchern von Cocktails, Destillaten, Speisen, Käse usw.
Selbstschließende Injektionsklappe aus Silikon (200°C).

Lid in the shape of a CD for creating a hermetic effect while smoking meats.
Can be used with all kinds of container, glasses, cocktail glasses, jars, etc.
Perfect for smoking cocktails, liquors, food, cheese, etc.
Injection valve with silicone self seal (200°C).

Tampa redonda com efeito hermético para defumar.
Válida para todo o tipo de recipientes, como copos, shakers, frascos, etc.
Ideal para defumar cocktails, destilados, comidas, queijos, etc.
Válvula de injeção com fecho automático de silicone (200°C).

▶ MANGUERA DOBLE PARA AHUMADOR

New



Mangueras de goma flexible
Flexible rubber hoses



Ahorra tiempo. Permite ahumar dos platos a la vez.
Save time. Two dishes can be smoked at once.

Permite ahumar dos platos a la vez, ahorrando tiempo.
Incluye 2 mangueras de goma de 40 cm, 2 boquillas y un conector de conexión de mangueras.

Il permet de fumer deux plats à la fois, économisant ainsi du temps.
Il comprend deux tuyaux en caoutchouc de 40 cm, deux embouts et un raccord de tuyaux.

Kann zwei Teller auf einmal räuchern und spart so Zeit.
Zwei 40 cm Gummischläuche, zwei Mundstücke und ein Schlauchverbinder.

Two dishes can be smoked at once to save time.
Two 40 cm rubber hoses, two nozzles and a hose connector included.

Permite defumar dois pratos simultaneamente, poupando tempo.
Inclui duas mangueiras de borracha de 40 cm, duas bocanilhas e um conector para as mangueiras.

Goma

Rubber

Manguera doble para ahumador
Double tuyau pour fumeur
Doppelschlauch für Räucherapparat
Double hoses for smoker
Mangueira dupla para defumador



Ref € U.Venta

69521 7,47 1

▶ SERRÍN



100 g

La mejor elección para ahumar todo tipo de alimentos
The best choice to smoke all kinds of food

Natural 100% Quality

OLIVO: Aporta a los alimentos un sabor suave y aromático.
NARANJO: Aporta a los alimentos un sabor dulce, afrutado y el frescor de los cítricos.
LIMONERO: Aporta a los alimentos un toque cítrico y dulce muy suave.
ALMENDRO: Aporta a los alimentos un aroma suave, dulce y floral de la almendra.
Producen un humo denso y de alta calidad.
Cumplen todas las normativas y reglamentaciones existentes para el empleo con alimentos.

OLIVE: Apporte aux aliments un goût doux, fruité et la fraîcheur des agrumes.
ORANGE: Apporte aux aliments un arôme délicat, doux et floral d'orange.
CITRONNIER: Apporte aux aliments une touche d'agrumes douce et très délicate.
AMANDIER: Apporte aux aliments un arôme délicat, doux et floral d'amande.
Produit une fumée dense et de grande qualité.
Respecte toutes les normes et réglementations existantes pour un usage alimentaire.

OLIVE: Verleiht Lebensmitteln ein weicher und aromatischer Geschmack.
ORANGE: Verleiht Lebensmitteln einen süßen, fruchtigen Geschmack und die Frische von Zitrusfrüchten.
ZITRONENBAUM: Verleiht Lebensmitteln einen feinen süß-sauren Geschmack.
MANDELBAUM: Verleiht Lebensmitteln ein feines, süßes, blumiges Mandelaroma.
Verleiht Lebensmitteln einen feinen süß-sauren Geschmack.
Erzeugt ergiebigen und hochwertigen Rauch.
Erfüllt alle Normen für Lebensmittelbedarfsgegenstände.

OLIVE: Provides food a smooth and aromatic flavour.
ORANGE: Provides food a sweet, fruity taste and citrusy freshness.
LEMON: Provides food a very soft, sweet, citrusy touch.
ALMOND: Provides food with a soft, sweet, floral aroma of almonds.
The best choice for smoking all kinds of food.
Produces dense, high-quality smoke.
Meets all existing regulations and standards for use with food.

AZEITONA: Proporciona aos alimentos um sabor suave e aromático.
LARANJA: Proporciona aos alimentos um sabor doce, frutado e a frescura dos cítricos.
LIMONERO: Proporciona aos alimentos um toque cítrico e doce muito suave.
ALMÔNDO: Proporciona aos alimentos o aroma suave, doce e floral da amêndoa.
Produz um fumo denso e de grande qualidade.
Cumre com todas as normativas e regulamentações vigentes para a sua utilização com alimentos.



600 g

Serrín de madera

Scire de bois
Räuchermehl
Wood chips
Serrín de madeira

Ref € g U.Venta

69550	6,33	100	1	Olivo / Olive
69551	6,33	100	1	Naranja / Orange
69552	6,33	100	1	Limonero / Lemon
69553	6,33	100	1	Almendro / Almond
69555	8,51	600	1	Olivo / Olive
69556	8,51	600	1	Naranja / Orange
69557	8,51	600	1	Limonero / Lemon
69558	8,51	600	1	Almendro / Almond

New

New

New

New

CENTRIFUGADORAS

Práctica y cómoda
Practical and comfortable



PP

Polypropileno

Centrifugadora Profesional

Essoreuse à salade
Salatschleuder
Salad spinner drier
Centrifugadora Profesional

Ref.	€	Ø (cm)	h (cm)	L	U.Venta
61420	175,86	32	33	12,0	1
61425	195,98	42	40	25,0	1

Artículo no vendido en France



Gracias a su gran velocidad de centrifugado las centrifugadoras NO escurren sino que secan la verdura por completo en segundos.

Funcionamiento muy sencillo.

El giro del cestillo hará que el agua se desplace fuera, dejando las verduras y vegetales secos.

Compuesta por tapa desmontable, escurridor y bol para hacer uso también por separado.

Grâce à sa grande vitesse d'essorage l'essoreuse sèche complètement les légumes au lieu de simplement les essorer en quelques secondes.

Fonctionnement très simple.

La rotation du panier fera se déplacer l'eau vers l'extérieur, laissant ainsi les légumes secs.

Composée d'un couvercle démontable, d'un panier de filtrage et d'un bol pouvant également être utilisé séparément.

Dank der hohen Schleudergeschwindigkeit entwässert es NICHT sondern trocknet das Gemüse sekundenschnell.

Einfache Funktionsweise.

Die Drehung des Körbchens treibt das Wasser nach außen und trocknet Gemüse und pflanzliche Erzeugnisse.

Bestehend aus einem abnehmbarem Deckel, Abtropfsieb und Gefäß, die auch getrennt verwendbar sind.

Thanks to its high centrifugal speed the kreissel NO drips and completely dries the vegetables in seconds.

Very easy to operate.

The rotation of the basket causes the water to exit, leaving the vegetables dry. Includes a removable lid, colander and bowl that can be used separately.

A sua grande velocidade de centrifugação as centrifugadora secan completamente a verdura, sem a escorrer em segundos.

Função simples.

A rotação do cesto faz com que a água se desloque para fora, deixando as verduras e os vegetais secos.

Inclui tampa desmontável, escurridor e taça que se podem utilizar por separado.



700 r.p.m.

3 en 1
3 in 1



PP

ASA

Polypropileno

Acrylic

Centrifugadora WHITE

Essoreuse
Salatschleuder
Spinner
Centrifugadora

Ref.	€	Ø (cm)	L	U.Venta
61403	25,21	26x20	5,00	1

Inox

ASA

Acrylic

Centrifugadora

Essoreuse
Salatschleuder
Spinner
Centrifugadora

Ref.	€	Ø (cm)	L	U.Venta
61404	67,96	24	4,00	1



3 en 1
3 in 1

Incluye tapa
Includes lid



Inox

Centrifugadora Inox

Essoreuse en Inox
Salatschleuder, Rostfrei
St. Steel Spinner
Centrifugadora Inóx

Ref.	€	Ø (cm)	L	U.Venta
61405	84,87	24	4,50	1



Básculas + Termómetros
Scales + Thermometers

#CocinaConLacor

BÁSCULAS PROFESIONALES



Cabezal orientable y abatible
Retractable, swivelling head

Plataforma inoxidable 53x44cm (21"x17")
Batería interna recargable (Autonomía 15 días)
Cuerpo aluminio fundido
Patas de apoyo regulables
Visor de nivel, planitud
Avisador acústico de sobrecarga
Teclado intuitivo y de fácil uso
Funciones de calculadora
Acumulación de importes
Unidades de medida (Kgs., Oz., Libras)
Función de tara
Libro de instrucciones en 7 idiomas

Platéeu inoxydable 53x44 cm
Batterie interne rechargeable (Autonomie 15 jours)
Corps en aluminium moulé
Pieds réglables
Indicateur de niveau, de planité
Avertisseur acoustique de surcharge
Clavier intuitif d'utilisation facile
Fonctions de calculatrice
Accumulation de sommes
Unités de mesure (Kgs., Oz., Livres)
Fonction de tare
Mode d'emploi en 7 langues

Rohrrei Auflegeläche 53x44 cm
Integrierte aufladbare Batterie (Ladungsdauer 15 Tage)
Gießkörper aus Aluminiumguss
Regulierbare Stützfüße
Nivellierung, Planheitsanzeige
Akustischer Warnton bei Überlastung
Berührungsempfindliche, einfach anzuwendende Tastatur
Rechenfunktionen
Kumulation mehrerer Bezüge
Gewichtseinheiten (Kgrs., Oz., Pfund)
Tara-Funktion
Handbuch in 7 Sprachen

St. Steel platform, 53x44 cm
Rechargeable internal battery (Last 15 days)
Cast aluminium case
Adjustable support feet
Level and flatness indicator
Overload alarm
Intuitive and easy-to-use keyboard
Calculator functions
Total counts
Measurement units (Kilgs., Oz., pounds)
Tare function
Instructions book in 7 languages

Plataforma inoxidable 53x44 cm
Batería interna recargable (Autonomía 15 días)
Cuerpo aluminio fundido
Patas de apo regulables
Vidor de nivel, planitud
Avisador acústico de sobrecarga
Teclado intuitivo y de fácil uso
Función de calculadora
Acumulación de importes
Unidades de medida (Kgs., Oz., pounds)
Función de tara
Libro de instrucciones en 7 idiomas



Báscula electrónica con base cuadrada 150 Kg (20 g)

Balance professionnel électronique 150 Kgs. (20g)
Elektronische Küchenwaage mit rechteckigem Oberteil 150 Kg (20g)
Electronic bench scale w/square base 150 Kg (20g)
Balança electrónica com base quadrada 150 Kg (20 g)

Ref	€	U.Venta
61700	985.46	1

Ref	Tensión/Voltage	Tara/Tare	Dimensiones/Sizes	Peso/Weight
61700	220-240 V / 50-60 Hz	150 Kgr (20 g)	49x75x90 cm	45 Kg

CERTIF.: 89/336/ECC, 91/263/EEC, 92/31/ECC, 93/68/EEC en 50 082 - 1:1992



Plataforma inoxidable 30x24 cm (12"x9 1/2")
Cable conexión 230V 50 Hz
Batería interna recargable (Autonomía 15 días)
Doble display
Plataforma extraíble, fácil limpieza
Patas de apoyo regulables
Visor de nivel, planitud
Avisador acústico de sobrecarga
Teclado intuitivo y de fácil uso
Funciones cambio
Seis memorias programables
Unidades de medida (Kgs., Oz., Libras)
Función de tara
Libro de instrucciones en 7 idiomas

Platéeu inoxydable 30x24 cms. (12"x9 1/2")
Câble connexion 230 V 50 Hz
Batterie interne rechargeable (Autonomie 15 jours)
Double display
Platéeu amovible, nettoyage facile
Pieds réglables
Indicateur de niveau, de planité
Avertisseur acoustique de surcharge
Clavier intuitif d'utilisation facile
Fonctions changement
Six mémoire programmables
Unités de mesure (Kgs., Oz., Livres)
Fonction de tare
Mode d'emploi en 7 langues

Rohrrei Auflegeläche 30x24 cms. (12"x9 1/2")
Anschlußkabel 230 V 50 Hz
Integrierte aufladbare Batterie (Ladungsdauer 15 Tage)
Doppelles Display
Abnehmbare Stützfläche einfache Reinigung
Regulierbare Stützfüße
Nivellierung, Planheitsanzeige
Akustischer Warnton bei Überlastung
Berührungsempfindliche, einfach anzuwendende Tastatur
Rechenfunktionen
Sechs programmierbare Speicher
Gewichtseinheiten (Kgrs., Oz., Pfund)
Tara-Funktion
Handbuch in 7 Sprachen

St. Steel platform, 30x24 cms. (12"x9 1/2")
230 V 50 Hz connection cable
Rechargeable internal battery (Last 15 days)
Double display
Removable, easy-to-clean platform
Adjustable support feet
Level and flatness indicator
Overload alarm
Intuitive and easy-to-use keyboard
Change functions
Six programmable memories
Measurement units (Kilgs., Oz., pounds)
Tare function
Instructions book in 7 languages

Plataforma inoxidable 30x24 cm (12"x9 1/2")
230 V 50 Hz cable de ligação
Batería interna recargable (Autonomía 15 días)
Duplo ecrã
Plataforma extraível, fácil limpeza
Patas de apo reguláveis
Vidor de nivel, planitud
Avisador acústico de sobrecarga
Teclado intuitivo y de fácil uso
Función de mudanza
Seis memorias programáveis
Unidades de medida (Kgs., Oz., pounds)
Función de tara
Libro de instruções em 7 idiomas



Báscula electrónica con base cuadrada

Balance de cuisine électronique
Elektronische Küchenwaage mit rechteckigem Oberteil
Electronic scale w/square base
Balança electrónica com base quadrada

Ref	€	Tara
61716	405.18	15kg/5g
61730	437.10	30kg/10g

Ref	Tensión/Voltage	Potencia/Power	Tara/Tare	IP	Dimensiones/Sizes	Peso/Weight
61716	220-240 V / 50-60 Hz	0.2 W (max)	15 Kgr (5 g)	IPX 54	30x32x12 cm	4.60 Kg
61730	220-240 V / 50-60 Hz	0.2 W (max)	30 Kgr (10 g)	IPX 54	30x32x12 cm	4.60 Kg

CERTIF.: OIML R76 Clase III, 60/384/ECC

▶ BÁSCULAS ELECTRÓNICAS



Inox 18/10  

Básculas perfectas para cualquier cocina.
 Función tara.
 Reseteo automático a cero.
 Pantalla LCD, fácil lectura de los resultados.
 Función de apagado automático para ahorrar energía.
 Indicador de batería baja y sobrecarga.

Balances parfaites pour toutes les cuisines.
 Fonction tare
 Mise à zéro automatique
 Écran LCD, lecture facile des résultats.
 Fonction d'arrêt automatique pour permettre des économies d'énergie.
 Indicateur de batterie faible et de surcharge.

Waages, ideais für jede Küche.
 Tara-funktion
 Automatisches Zurücksetzen.
 LCD-Screen, einfache Ablesung der Messwerte.
 Energiesparende automatische Abschaltung.
 Batteriestands- und Überlastanzeige.

This scales is perfect for any kitchen.
 Tare function.
 Automatic reset to zero.
 LCD screen with easy to read results.
 Automatic shut-off to save energy.
 It has a low battery and overload indicator.

Balanças perfeitas para qualquer cozinha.
 Função de tara
 Posição a zero automática
 Ecrã LCD, para uma leitura fácil dos resultados.
 Função de desconexão automática para poupar energia.
 Indicador de bateria baixa e de sobrecarga.



Báscula digital con bol extraíble
 Balance numérique avec bol amovible
 Digitalwaage mit abnehmbarer Schale
 Scale digital with removable bowl
 Balança digital com bacia removível



Bol extraíble
 Bol amovible
 Abnehmbare Schale
 Removable bowl
 Bacia removível



Apertura y cierre deslizante
 Ouverture et fermeture glissante
 Öffnen und Schließen slide
 Opening and closing slide
 Abertura e fechamento deslizante



Marcas de llenado
 Graduation
 Füllmarken
 Filler marking
 Marcas de enchimento



Teclado - Pantalla
 Clavier - Écran
 Keyboard - Bildschirm
 Keyboard - Display
 Teclado - tela

Ref	€	Ø (cm)	L	Kg	División (g)	U.Venta
61707	30,92	21 (bol)	1,50	5	1	1

4 sensores de alta precisión
 Four high precision sensors

15 kg
 max



Báscula de cocina EBEN
 Balance de cuisine
 Küchenwaage
 Kitchen scale
 Balança de cozinha

Ref	€	Kg	División (g)	cm	Unidades	U.Venta
61717	47,52	15	1	31x25,6x2,5	g/Kg/oz/lb/oz	1

Báscula de cocina electrónica
 Balance de cuisine électronique
 Elektronische Küchenwaage
 Electronic kitchen scale
 Balança cozinha electrónica



Ref	€	Kg	División (g)	cm	U.Venta
61703	52,29	5	1	15,5x12	1

Báscula electrónica

Balance Électronique
Elektronische Küchenwaage
Electronic scale
Balança Electrónica



Ref	€	Kg	División (g)	Ø Cristal (cm)	U.Venta
61735	32,06	5	1	18	1

Báscula sobremesa cristal

Balance électronique pour cuisine
Elektronische Küchenwaage
Electronic kitchen scale
Balança sobremesa em vidro



Ref	€	Kg	División (g)	U.Venta
61725	19,61	5	1	1

Plataforma de pesaje en bambú
Bamboo weighing platform

**Báscula BAMBOO**

Balance
Küchenwaage
Scale
Balança

Ref	€	Kg	División (g)	cm	Unidades	U.Venta
61712	20,65	5	1	21,8x18,8x2,1	g/ml/lb/oz/fl-oz	1

Plataforma de pesaje en cristal
Glass weighing platform

**Báscula electrónica**

Balance électronique
Elektronische Küchenwaage
Electronic scale
Balança electrónica

Ref	€	Kg	División (g)	cm	Unidades	U.Venta
61708	23,66	5	1	27x18x4	g/oz/ml/cups	1

Báscula de baño

Pèse personne
Personenwaage
Bathroom scale
Escala de banheiro



Ref	€	Kg	División (Kg)	cm	Unidades	U.Venta
61740	27,81	180 (347 lb)	0,1 (0,22 lb)	31x31x4	Kg / lb	1

Báscula con gancho PROFESIONAL

Balance électronique avec crochet
Elektronische Küchenwaage mit Haken
Electronic scale w/hook
Balança de gancho



Ref	€	Kg	División (g)	cm	U.Venta
61722	63,08	0 - 50 50 - 150	20 100	32x10	1

**Báscula con gancho**

Balance électronique avec crochet
Elektronische Küchenwaage mit Haken
Electronic scale w/hook
Balança de gancho

Ref	€	Kg	División (g)	U.Venta
61721	19,71	10	5	1

▶ BÁSCULAS PRECISIÓN

Inox



Cuchara medidora digital

Cuillère avec Balance Digital
Digitale Löffelwaage
Digital spoon scale
Colher de pesar Digital



Ref	€	g	División (g)	L (cm)	U.Venta
62519	34.34	300	0,10	28	1

Diseñadas para un pesaje muy preciso. Elabore recetas vanguardistas. La precisión de estas básculas ayudará a pesar los ingredientes más exclusivos. Compacta, ahorra espacio de almacenamiento.

Conçues pour une pesée très précise. Élaborez des recettes avant-gardistes. La précision de cette balance aidera à peser les ingrédients les plus exclusifs. Compacte, elle permet de gagner de l'espace de rangement.

Designed for very precise weighing. Create nuanced recipes. The precision of this scale will help you weigh the most exclusive ingredients. Compact, to help save storage space.



Báscula de precisión de bolsillo

Balance de précision de poche
Taschen-Präzisionswaage
Pocket precision scale
Balança de precisão de bolso



Ref	€	g	División (g)	cm	U.Venta
61709	15.04	650	0,1	13x8x2	1

Incluye 2 bandejas para el pesaje (ABS plastic)

Includes 2 weighing trays

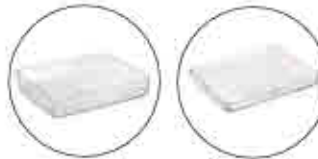

11x13x2 cm

10,5x10,5x0,5 cm



Báscula de precisión BLACK

Balance de précision
Präzisionswaage
Precision scale
Balança de precisão

Ref	€	Kg	División (g)	cm	U.Venta
61711	15.77	2	0,1	12,7x10,6x1,7	1

▶ BÁSCULAS MECÁNICAS

Inox
18/10

Báscula RETRO WHITE

Balance
Küchenwaage
Scale
Balança



Ref	€	Kg	División (g)	Ø Bol (cm)	U.Venta
61714	32.27	5	20	24 (2L)	1

Báscula mecánica con bol

Balance mécanique avec plateau creux
Mechanische Waage mit Schale
Mechanical scale w/bowl
Balança mecânica com bacia



Ref	€	Kg	División (g)	Ø Bol (cm)	U.Venta
61705	47.52	5	20	20,5x4	1
61710	48.97	10	50	20,5x4	1



Báscula cocina plástico cromado

Balance de cuisine Chrome
Küchenwaage, verchromt
Chromed body kitchen scale
Balança cozinha plástico cromada



Ref	€	Kg	División (g)	U.Venta
61702	17.53	1	5	1

Báscula mecánica con plato

Balance mécanique avec plateau plat
Mechanische Waage mit flachem Oberteil
Mechanical scale w/plain top
Balança mecânica com prato



Ref	€	Kg	División (g)	U.Venta
61715	73.77	15	50	1

TERMÓMETROS



300°C (oven)
50°C (oven)



Termómetro horno con base

Thermomètre avec base pour four
Backofen-Thermometer mit Ständer
Oven thermometer with base
Termómetro forno com base

Ref	€	U.Venta
62454	8,51	1



30°C (oven)
-30°C (oven)

Termómetro refrigerador con base

Thermomètre avec base pour réfrigérateur
Kühlschrankschermometer mit Ständer
Refrigerator thermometer with base
Termómetro refrigerador com base

Ref	€	U.Venta
62450	6,64	1



200°C (oven)
40°C (oven)

Termómetro analógico de aceite

Thermomètre analogique de huile
Analog Thermometer für Öl
Oil analog thermometer
Termómetro analógico óleo

Ref	€	cm	U.Venta
62495	10,89	5x30,5	1

88°C (oven)
54°C (oven)

Termómetro carne

Thermomètre à cadran avec sonde pour viande
Fleisch-Thermometer
Meat thermometer
Termómetro de carne

Ref	€	L (cm)	U.Venta
62452	7,26	11	1



300°C (oven)
0°C (oven)



Termómetro Digital con alarma

Thermomètre numérique avec Alarme
Digital Thermometer mit Alarm
Digital thermometer with Alarm
Termómetro Digital con Alarme

Ref	€	Ø (cm)	U.Venta
62487	26,15	5x23	1

150°C (oven)
-40°C (oven)



Termómetro electrónico carne

Thermomètre Electronique a/sonde pour viande
Fleisch - Thermometer, Elektronisch
Electronic meat thermometer
Termómetro electrónico de carne

Ref	€	L (mm)	U.Venta
62453	18,05	150	1

150°C (oven)
-40°C (oven)



Termómetro electrónico

Thermomètre Electronique
Electric Thermometer
Thermometer, Elektronisch
Termómetro Electrónico

Ref	€	U.Venta
62459	18,15	1

220°C (oven)
-33°C (oven)



Termómetro DUAL Infrarrojos - Sonda

Thermomètre Dual Infrarouge - Sonde
Dual-Thermometer Infrarot - Sonde
Dual Thermometer Infrared - Probe
Termómetro dupla infravermelhos - Sonda

Ref	€	U.Venta
62458	90,89	1



La lente debería mantenerse limpia en todo momento
The lens should be kept clean at all times



Espátula
Funda de silicona extraíble
Spatula
Removable silicone sleeve

Termómetro
Sonda de acero inoxidable
Thermometer
Stainless steel probe

2 en 1
2 in 1



Espátula silicona con termómetro sonda

Spatule en silicone avec Thermometre sonde
Teigschaber mit Thermometer Messfüßer
Silicone spatula with Thermometer probe
Espátula silicona con Termómetro sonda

Ref	€	L (cm)	U.Venta
62500	13.90	25	1



Cuchara
Funda de silicona extraíble
Spoon
Removable silicone sleeve

Termómetro
Sonda de acero inoxidable
Thermometer
Stainless steel probe

2 en 1
2 in 1



Cuchara silicona con termómetro sonda

Quillière en silicone avec Thermometre sonde
Digikünlöffel mit Thermometer Messfüßer
Silicone spoon with Thermometer probe
Colher silicone com Termómetro sonda

Ref	€	L (cm)	U.Venta
62528	14.94	25	1

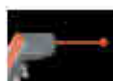

NUNCA APUNTE CON EL DISPOSITIVO LOS OJOS DE ALGUIEN

NEVER POINT THE INSTRUMENT TOWARDS ANYONE'S EYES.
Das Gerät niemals auf Augen von Personen richten.
Never point the device towards anyone's eyes.
Nunca apuntes el aparato hacia los ojos de alguien.



400°C (228°F)
-50°C (58°F)

Termómetro Infrarrojos puntero laser y funda

Therm. mesure de surface par infra rouge à visée Laser et son étui

Infrarot Thermometer mit Lichtzeiger/Hülle
Infrared Thermometer W/Laser Pointer/Pouch

Termómetro infravermelhos puntero laser e interior

Ref	€	U.Venta
62457	107.69	1

Base magnética para fijación sobre superficies metálicas.

Base magnétique pour fixation sur de superficies métalliques.
Magnetische Unterseite zum Befestigen auf metalloberfläche.
Magnetic base to fix metal surfaces.
Base magnética para fixação sobre superficies metálicas.



300°C (572°F)
0°C (32°F)

Termómetro Digital horno con sonda

Thermomètre Numérique pour le four avec sonde

Digitaler Ofen-Thermometer mit Messfüßer
Oven Digital Thermometer with probe

Termómetro digital forno com sonda

Ref	€	cm	U.Venta
62498	43.47	12x7,5	1

Doble pantalla para nevera y congelador. Base magnética.

Double écran pour réfrigérateur et congélateur.
Base magnétique.

Doppeltanzeige für Kühlschrank und Gefrierschrank.
Magnetische Unterseite.

Double screen for fridge and freezer.
Magnetic base.

Dupla parede, para frigorífico e congelador.
Base magnética.



70°C (158°F)
0°C (32°F)
-40°C (40°F)

Termómetro alarma para nevera/congelador

Thermomètre alarme de réfrigérateur/congélateur

Thermometer, m/Alarm f/Kühlschrank/Gefrierfach
Fridge/Freezer Alarm Thermometer

Termómetro alarme para refrigerador/congelador

Ref	€	U.Venta
62456	33.10	1

Alcance la temperatura deseada.
Escala de temperatura en grados Celsius.
Protector de plástico.

Atteint la température souhaitée
Échelle de température en degrés Celsius
Protecteur en plastique

Die gewünschte Temperatur erreicht.
Temperaturskala in Grad Celsius.
Kunststoff-Schutzfolie.

Reaches the desired temperature
Celsius temperature scale
Plastic protector

Atinge a temperatura desejada.
Escala de temperatura em graus Celsius.
Protetor de plástico.



PP
Polipropileno

Termómetro de leche
Thermomètre à lait
Milch Thermometer
Milk thermometer
Termômetro de leite

Ref	€	L (cm)	T°	Unidad	U.Venta
62532	10,38	26,5	-10°C/110°C	°C	1



Ideal para medir las temperaturas de cocción (azúcar, caramelo, mermelada, etc...)
Escala de temperatura en grados Celsius y Fahrenheit.
Clip de sujeción (Cacerolas) y bola de madera para un fácil manejo.
Funda de protección incluida.

Idéal pour mesurer les températures de cuisson (sucre, bonbons, confitures, etc...)
Échelles de température en degrés Celsius et Fahrenheit.
Clip de fixation (Faitout) et boule en bois pour une utilisation aisée.
Couverture de protection incluse

ideal zur Messung der Temperaturen der Koch (Zucker, Süßigkeiten, Marmelade usw.)
Temperaturskala in Grad Celsius und Fahrenheit.
Hafteclip (Brätertopf) und Holzkuigel zur leichten Bedienung
Einschließlich Schutzetui.

ideal for measuring the temperatures of cooking (sugar, candy, jam, etc.)
Celsius and Fahrenheit temperature scales.
Hanging clip (Casserole) and wooden ball for easy handling.
Protective cover included.

Idéal para medir as temperaturas de cozimento (açúcar, doces, compotas, etc.)
Escala de temperatura em graus Celsius e Fahrenheit.
Clipo de fixação (Cacerolas) e bola de madeira para um fácil manuseio
Cobertura de proteção incluído.



Termómetro de azúcar
Thermomètre à sucre
Zuckerthermometer
Sugar thermometer
Termômetro de açúcar

Ref	€	L (cm)	T°	Unidades	U.Venta
62533	4,36	21,5	200°C (400°F)	°C / °F	12



▶ RELOJES



Magnético
Magnetic

Resistente al agua
Water resistance

12
IP65 99:99:99

Reloj de cocina con alarma
Minuteur de Cuisine avec Alarme
Küchen Zeitschaltuhr mit Alarm
Kitchen Timer Alarm
Relógio de cozinha com alarme

Ref	€	cm	U.Venta
60804	33,41	13x24,5x2,5	1

Alarma acústica programable
Alarme acoustique programmable
Programmierbarer akustischer Alarm
Programmable acoustic alarm
Alarme sonoro programável



Parte posterior magnética
Magnetic back



Reloj Digital de cocina con avisador acústico
Minuteur Électronique
Digitale Küchen-Zeitschaltuhr mit Alarm
Digital kitchen timer w/ alarm
Relógio digital de cozinha com alarme acústico.

Ref	€	cm	U.Venta
60805	7,78	10,5x7	1



Magnético
Magnetic

Reloj de cocina magnético
Minuteur de cuisine magnétique
Magnetküchentimer
Magnetic kitchen timer
Relógio de cozinha magnético

Ref	€	Tiempo	cm	U.Venta
60803	9,23	60 min	9,2x3,5	1







MESA TABLE TOP

Bandejas / Fuentes
Trays

Servicio mesa
Table Service

Pinzas
Tongs

Cafetería
Cafeteria

Termos
Thermos

Bar / Bodega
Bar / Wine Cellar

Porta menú
Menu cover

▶ BANDEJAS / PLATOS INOX



Inox



Para uso profesional o doméstico.
Fabricadas en acero inoxidable de alta calidad.
Excelente resistencia a la corrosión.
Ideal para servir o presentar todo tipo de comidas en buffets, restaurantes o en casa.

Pour un usage professionnel ou domestique
Fabriqués en acier inoxydable de grande qualité.
Excellente résistance à la corrosion.
Parfaits pour servir ou présenter tout type d'aliments dans des buffets, des restaurants ou à la maison.

Für Profis oder für Zuhause
Aus hochwertigem Edelstahl.
Sehr korrosionsbeständig.
Ideal zum Servieren oder Anrichten aller möglichen Speisen in Buffets, Restaurants oder Zuhause.

For professional or home use
Made from high-quality stainless steel.
Extremely resistant to corrosion.
Ideal for serving and presenting all types of food in buffets, restaurants, or even at home.

Para uso profissional ou doméstico
Fabricadas em aço inoxidável de alta qualidade.
Excelente resistência à corrosão.
Ideais para servir ou apresentar todo o tipo de comidas no buffet, em restaurantes e em casa.

Inox
18/10

Fuente Oval pulido satinado

Plat ovale poli-satine
Buffet-Tablett, oval
Oval dish satin polish
Travessa oval pulido mate

Ref	€	cm	U.Venta
62820	7,47	20x13	1
62825	9,44	25x17	1
62830	11,83	30x20	1
62835	14,63	35x23	1
62840	19,19	40x26	1
62845	21,79	45x29	1
62850	26,15	50x31	1



Fuente Oval

Plat ovale
Buffet-Tablett, oval
Oval dish
Travessa oval

Ref	€	cm	U.Venta
61820	5,08	20x13	1
61825	7,26	25x17	1
61830	7,89	30x20	1
61835	9,86	35x23	1
61840	11,83	40x26	1
61845	13,80	45x29	1
61850	16,91	50x31	1
61871	39,22	70x45	1
61881	45,86	80x48	1



Fuente de pescado

Plat à poisson
Fischplatte
Fish tray
Travessa peixe

Ref	€	cm	U.Venta
61860	24,49	60x27	1
61880	30,92	80x30	1

Fuente redonda

Plat rond
Bratenplatte, rund
Round serving dish
Travessa redonda

Ref	€	Ø (cm)	U.Venta
61831	9,55	30	6
61836	11,93	35	6



F. Honda Oval
 Plat à gratin ovale
 Schale, oval
 Deep oval dish
 Travessa funda oval



Ref	€	cm	h (cm)	U.Venta
61828	11.93	30x20	4,5	1
61832	14.53	35x24	4,5	1
61838	17.85	40x26	4,5	1
61843	19.30	45x29	4,5	1
61848	23.03	50x31	4,7	1

Inox
18/10

Bandeja octogonal
 Plateau octogonal
 Platte, achteckig
 Octogonal tray
 Bandeja octogonal



Ref	€	cm	U.Venta
65031	47.00	31x24	1
65037	57.06	37x27	1
65041	100.02	41x32	1
65046	131.35	46x36	1



Bandeja de marisco
 Plateau a fruit de mer
 Platte für Seemuschel
 Sea food tray
 Bandeja de mariscos



Ref	€	Ø (cm)	U.Venta
14027	8.30	28	6
14042	18.57	42	1
14050	29.05	50	6

Soporte para bandeja de mariscos
 Support pour plateau a fruit de mer
 Ständer für Seemuschelplatte,
 Stand for sea food tray
 Soporte para bandeja de mariscos



Ref	€	Ø Sup. (cm)	Ø Inf. (cm)	h (cm)	U.Venta
14100	12.55	24,5	19	20	1

Inox
18/10

Bandeja camarero pulido satinado
 Plateau limonadier poli-satine
 Serviertablett, rund
 Serving tray satin polish
 Bandeja de servir pólido mate



Ref	€	Ø (cm)	U.Venta
62841	23.76	40	1

Bandeja camarero
 Plateau limonadier.
 Serviertablett, rund
 Serving tray
 Bandeja de servir



Ref	€	Ø (cm)	U.Venta
61841	17.53	40	1



Bandeja camarero
 Plateau limonadier
 Serviertablett
 Serving tray
 Bandeja de servir



Ref	€	Ø (cm)	U.Venta
14135	8.72	32	6
14136	10.06	36	1
14145	17.02	45	1

Inox
18/10**Bandeja con pinza para notas**

Porte addition à pince

Platte mit Klemmvorrichtung

Bill holder

Bandeja com pinça para notas

	Ref	€	cm	U.Venta
A	68007	4,57	11x15,2	12
B	68017	5,40	12x21,5	12

PP ABS

Bandeja cambios COIN

Coupelle ramasse monnaie.

Wechselgeldablagen

Changetray

Bandeja para trocos

Ref	€	Ø (cm)	U.Venta
68720	2,70	13	12

**Plato de huevos**

Plat à oeufs

Eiteller

Egg serving dish

Prato de ovos



Ref	€	Ø (cm)	h (cm)	U.Venta
61116	4,46	16	3	6

Plato camping llano

Assiette plate de camping

Camping Platzteiler

Camping dinner plate

Prato camping raso



Ref	€	Ø (cm)	U.Venta
61121	6,12	22	1

Plato camping hondo Inox

Assiette creuse de camping

Camping Teller, tief

Deep camping dinner plate.

Prato camping fundo



Ref	€	Ø (cm)	U.Venta
61122	6,54	22	6

Posabotellas

Dessous de bouteille

Flaschenuntersetzer

Bottle stand

Pousa-garrafas



Ref	€	Ø (cm)	U.Venta
61113	3,32	13	6

Posavasos

Sous-verre

Glasuntersetzer

Glass stand

Pousa-copos



Ref	€	Ø (cm)	U.Venta
61110	2,80	10,5	6

▶ BANDEJAS PIZARRA



Pizarra natural 100% · 100% natural slate



Totamente artesanales, cada bandeja es única e irreplicable.
Ideal para la presentación de platos fríos y calientes.
Ofrecen un aire de modernidad, elegancia y simpleza.
Excelente conductor del frío y del calor.
Evita los cambios bruscos de temperatura para su conservación.
Para conservarlas brillantes y con su color natural, cada ciertos usos impregnarlas con aceite de oliva virgen extra por ambas caras y cantos.
Contienen tacos antideslizantes para asegurar su estabilidad.

Totalemtent artisanaux, chaque plateau étant unique et irimitable.
Idéal pour la présentation de plats froids et chauds.
Ils apportent un air de modernité, d'élegance et de simplicité.
Excellent conducteur du froid et de la chaleur.
Évite les changements de température brusques pour leur conservation.
Pour conserver leur brillance et leur couleur naturelle, il faut les imprégner régulièrement d'huile d'olive vierge sur les deux côtés et sur les bords.
Possèdent des taquets antidérapants pour assurer leur stabilité.

Handgefertigte Einzelsücke aus Schiefer.
Ideal zum Anrichten kalter und warmer Speisen.
Modern, schlicht und elegant.
Hervorragende Temperaturleitfähigkeit.
Temperaturempfindlich, nicht schnell erhitzen oder abkühlen.
Nach längerem Gebrauch Poltur aus Olivenöl zum Erhalt von Farbe und Glanz beidseitig und an den Rändern auftragen.
Stabilisierende Antirutschunterlagen imbegriffen.

Entirely handmade, every tray is unique and unreproducible.
Perfect for presenting hot and cold dishes.
They have an air of modernity, elegance and simplicity.
Excellent conductor of heat and cold.
Avoid abrupt temperature changes to prevent damage.
After every few uses, wipe the edges and both faces thoroughly with extra virgin olive oil to preserve their brightness and natural colour.
They have anti-slip feet to ensure stability.

Totamente artesanais, sendo cada bandeja única e irrepelível.
Ideal para a apresentação de pratos frios e quentes.
Com um estilo moderno, simples e elegante.
Excelente condutor do frio e do calor.
Evita as mudanças bruscas de temperatura, conservando melhor a temperatura dos alimentos.
Para as conservar brilhantes e com a sua cor natural, impragná-las periodicamente com azeite virgem extra em ambas as faces e dos lados.
Com tacos antidesslizantes que asseguram uma boa estabilidade.

Bandeja cuadrada

Plateau carré
Servierblett, viereckig
Square tray
Bandeja quadrada



Ref	€	cm	e (mm)	U.Venta
61010	2,59	10x10	5	32
61015	3,84	15x15	5	32
61019	4,46	20x20	5	24
61044	13,90	40x40	5	8

Bandeja rectangular

Plateau rectangulaire
Servierblett, rechteckig
Rectangular tray
Bandeja rectangular



Ref	€	cm	e (mm)	U.Venta
61016	3,63	10x15	5	48
61021	4,25	15x20	5	24
61029	5,29	15x30	5	18
61031	6,64	20x30	5	12
61041	7,78	20x40	5	12
61051	11,00	20x50	5	8
61043	12,14	40x30	5	8
61064	24,69	60x40	5	3

Bandeja redonda

Plateau rond
Servierblett rund
Round tray
Bandeja redonda



Ref	€	Ø (cm)	e (mm)	U.Venta
61070	3,01	20	5	6
61071	4,36	25	5	6
61072	6,02	30	5	6
61073	8,40	35	5	4

▶ BANDEJAS FIBREGLASS



Para uso profesional.
Fabricadas en fibra de vidrio.
Superficie antiadherente y antideslizante.
Indeformables y muy ligeras.

Pour un usage professionnel.
 Fabriqué en fibre de verre.
 Surface antiadhésive et antidérapante.
 Indéformable et très légères.

Für den professionellen Gebrauch.
 Aus Glasfaser.
 Antihalt- und rutschfeste Oberfläche.
 Unverformbar und Sehr leicht.

For professional use.
 Made of fibreglass.
 Non-stick and non-slip surface.
 Undeformable and very light.

Para uso profesional.
 Fabricado em fibra de vidro.
 Superfície antiaderente e antiderrapante.
 Indeformável e extremamente leve.

Bandeja redonda

Plateau rond
 Serviertablett rund
 Round tray
 Bandeja redonda



Ref	€	Ø (cm)	U.Venta
69136	12,76	36	1
69140	18,88	40	1

Bandeja rectangular

Plateau rectangulare
 Serviertablett, rechteckig
 Rectangular tray
 Bandeja rectangular



Ref	€	cm	U.Venta
69146	22,10	36x46	1
69152	26,66	38x52	1
69156	33,82	40x56	6
69165	48,66	45x65	6

Bandeja oval

Plateau ovale
 Oval Serviertablett
 Oval tray
 Bandeja oval



Ref	€	cm	U.Venta
69168	57,89	56x68	6



Melamina
Melamine
#CocinaConLacor



Fabricadas en melamina de alta calidad. Libre de BPA.
Una completa gama que ofrece un aspecto rústico, con piezas únicas y elegantes.
Diseñadas para realizar las creaciones del Chef.
Ligeras, resistentes a golpes y choques térmicos.
Higiénicas y fácilmente lavables, aptas para lavavajillas.

Produits fabriqués en mélamine de grande qualité. Sans BPA.
Une gamme complète qui offre un aspect rustique, avec des pièces uniques et élégantes.

Conçus pour réaliser les créations du Chef!
Légers, résistants aux chocs et aux variations thermiques.
Hygiéniques et faciles à laver, après pour le lave-vaisselle.

Aus hochwertigem Melamin. Ohne BPA.
Eine komplette Palette einzigartiger, eleganter Artikel in rustikaler Optik.
Bringt die Kreationen des Küchenchefs noch besser zur Geltung.
Leicht, stoßfest. Widerstandsfähig gegen abrupte Temperaturwechsel.
Hygienisch und leicht zu reinigen. Spülmaschinengeeignet.

Made of high quality melamine. BPA free.
A full range with unique and elegant pieces and a rustic look.
Designed to highlight the Chef's creations.
Lightweight and resistant to impacts and thermal shock.
Hygienic, easy to wash and dishwasher safe.

Fabricadas em melamina de alta qualidade, sem BPA.
Uma gama completa, de aspeto rústico, com peças únicas e elegantes.
Desenhadas para realçar as criações do Chef.
Leves, resistentes aos golpes e aos choques térmicos.
Higiénicas e fáceis de lavar, aptas para máquinas de lavar louça.



Fuente rectangular
Plateau rectangulaire
Serviertablet, rechteckig
Rectangular tray
Travessa rectangular

Ref	€	cm	h (cm)	U.Venta
63833	9.55	28,6x12,7	3,4	1

Fuente rectangular
Plateau rectangulaire
Serviertablet, rechteckig
Rectangular tray
Travessa rectangular



Ref	€	cm	h (cm)	U.Venta
63831	8.51	21,7x13,6	3,1	1
63832	10.48	25,2x17,2	3,6	1
63834	17.53	30,8x21,6	3,5	1
63855	24.07	35x23,8	4,1	1

Fuente rectangular ondulada
Plateau rectangulaire ondulé
Serviertablet, rechteckig, gewellt
Rectangular undulated tray
Travessa rectangular ondulada



Ref	€	cm	h (cm)	U.Venta
63865	15.56	29x17,5	3,0	1

Fuente rectangular
Plateau rectangulaire
Serviertablet, rechteckig
Rectangular tray
Travessa rectangular



Ref	€	cm	h (cm)	U.Venta
63830	6.95	18,6x13,5	2,7	1

Fuente oval
Plateau oval
Oval platte
Oval tray
Travessa redonda



Ref	€	cm	h (cm)	U.Venta
63863	7.99	25,4x13	2,9	1

Fuente lágrima

Plateau larme
Träne platte
Tear tray
Travessa lágrima



Ref	€	cm	h (cm)	U.Venta
63854	14,11	28,2x21,4	4,8	1

Fuente oval

Plateau oval
Oval platte
Oval tray
Travessa redonda



Ref	€	cm	h (cm)	U.Venta
63852	7,06	19,7x14,1	3,7	1
63853	9,73	22,5x16,4	4,4	1
63864	15,25	28,4x19	5,1	1

Plato redondo

Plateau rond
Rund Teller
Round plate
Prato redondo



Ref	€	Ø (cm)	h (cm)	U.Venta
63841	5,08	15,5	2,4	1
63842	7,68	19,4	2,9	1
63843	8,20	21,5	3,2	1
63844	12,87	24,2	3,5	1
63845	14,94	25,6	3,7	1

Plato hondo redondo

Plateau profonde ronde
Rund tiefe Platte
Round deep plate
Prato profundo redondo



Ref	€	Ø (cm)	h (cm)	U.Venta
63839	7,68	17,7	4,4	1
63840	15,98	24	5,5	1

Bol redondo

Rond bol
Bowl rund
Bowl round
Bacia redonda



Ref	€	Ø (cm)	h (cm)	ml	U.Venta
63856	2,59	8,3	3,2	60	1
63857	4,05	9,5	4,6	130	1
63858	4,25	10,6	5,2	220	1
63859	5,91	12,6	6,0	300	1

Bol

Bol
Bowl
Bowl
Bacia



Ref	€	Ø (cm)	h (cm)	ml	U.Venta
63861	5,40	12,4	4,6	300	1

Bol cónico

Conique bol
Bowl Konish
Conical bowl
Bacia cónica



Ref	€	Ø (cm)	h (cm)	ml	U.Venta
63835	7,47	15,7	5,9	330	1
63836	9,03	18,3	6,8	560	1
63837	11,93	21,3	7,8	750	1
63838	16,81	24,2	8,8	1350	1

Bol oval

Bol oval
Oval bowl
Oval bowl
Bacia oval



Ref	€	cm	h (cm)	ml	U.Venta
63849	3,84	12x10	4,1	130	1
63860	6,54	16,3x12,3	4,7	220	1
63850	13,18	20,7x16,8	8,0	660	1
63851	20,54	24,2x20,6	9,3	1150	1

Fuente cuadrada

Plateau carrée
Quadratischen platte
Square tray
Travessa quadrado



Ref	€	cm	h (cm)	ml	U.Venta
63846	6,33	12x12	5,0	200	1
63847	13,38	19x19	6,0	370	1
63848	20,75	24x24	6,8	840	1

Bol salsa mini

Bol sauce mini
Bowl sauce mini
Sauce bowl mini
Bacia molho mini



Ref	€	cm	h (cm)	ml	U.Venta
63862	2,49	7,2x7,2	3,0	30	1



Fabricadas en melamina de alta calidad. Libre de BPA.
 Una completa gama que ofrece un aspecto rústico, con piezas únicas y elegantes.
 Diseñadas para realizar las creaciones del Chef.
 Ligeras, resistentes a golpes y choques térmicos.
 Higiénicas y fácilmente lavables, aptas para lavavajillas.

Produits fabriqués en mélamine de grande qualité. Sans BPA
 Une gamme complète qui offre un aspect rustique, avec des pièces uniques et élégantes.
 Conçus pour réaliser les créations du Chef.
 Légers, résistants aux chocs et aux variations thermiques.
 Hygiéniques et faciles à laver, aptes pour le lavé vaisselle.

Aus hochwertigem Melamin. Ohne BPA.
 Eine komplette Palette einzigartiger, eleganter Artikel in rustikaler Optik.
 Bringt die Kreationen des Küchenchefs noch besser zur Geltung.
 Leicht, stoßfest. Widerstandsfähig gegen abrupte Temperaturwechsel.
 Hygienisch und leicht zu reinigen. Spülmaschinengeeignet.

Made of high quality melamine. BPA free.
 A full range with unique and elegant pieces and a rustic look.
 Designed to highlight the Chef's creations.
 Lightweight and resistant to impacts and thermal shock.
 Hygienic, easy to wash and dishwasher safe.

Fabricadas em melamina de alta qualidade, sem BPA.
 Uma gama completa, de aspecto rústico, com peças únicas e elegantes.
 Desenhadas para realçar as criações do Chef.
 Leves, resistentes aos golpes e aos choques térmicos.
 Higiénicas e fáceis de lavar, aptas para máquinas de lavar louça.

Fuente rectangular

Plateau rectangulaire
 Serviertablet, rechteckig
 Rectangular tray
 Travessa rectangular



Ref	€	cm	h (cm)	U.Venta
63944	9,65	28,6x12,7	3,4	1

Fuente rectangular

Plateau rectangulaire
 Serviertablet, rechteckig
 Rectangular tray
 Travessa rectangular



Ref	€	cm	h (cm)	U.Venta
63942	8,51	21,7x13,6	3,1	1
63943	10,48	25,2x17,2	3,6	1
63945	17,53	30,8x21,6	3,5	1
63966	24,07	35x23,8	4,1	1

Fuente rectangular ondulada

Plateau rectangulaire ondulé
 Serviertablet, rechteckig, gewellt
 Rectangular undulated tray
 Travessa rectangular ondulada



Ref	€	cm	h (cm)	U.Venta
63976	15,56	29x17,5	3,0	1

Fuente rectangular

Plateau rectangulaire
 Serviertablet, rechteckig
 Rectangular tray
 Travessa rectangular



Ref	€	cm	h (cm)	U.Venta
63941	6,95	18,6x13,5	2,7	1

Fuente oval

Plateau oval
 Oval platte
 Oval tray
 Travessa redonda



Ref	€	cm	h (cm)	U.Venta
63974	7,99	25,4x13	2,9	1

Fuente lágrima

Plateau larme
Träne platte
Tear tray
Travessa lágrima



Ref	€	cm	h (cm)	U.Venta
63965	14,11	28,2x21,4	4,8	1

Fuente oval

Plateau oval
Oval platte
Oval tray
Travessa redonda



Ref	€	cm	h (cm)	U.Venta
63963	7,06	19,7x14,1	3,7	1
63964	9,73	22,5x16,4	4,4	1
63975	15,25	28,4x19	5,1	1

Plato redondo

Plateau rond
Rund Teller
Round plate
Prato redondo



Ref	€	Ø (cm)	h (cm)	U.Venta
63952	5,08	15,5	2,4	1
63953	7,68	19,4	2,9	1
63954	8,20	21,5	3,2	1
63955	12,87	24,2	3,5	1
63956	14,94	25,6	3,7	1

Plato hondo redondo

Plateau profonde ronde
Rund tiefe Platte
Round deep plate
Prato profundo redondo



Ref	€	Ø (cm)	h (cm)	U.Venta
63950	7,68	17,7	4,4	1
63951	15,98	24	5,5	1

Bol redondo

Rond bol
Bowl rund
Bowl round
Bacia redonda



Ref	€	Ø (cm)	h (cm)	ml	U.Venta
63967	2,59	8,3	3,2	60	1
63968	4,05	9,5	4,6	130	1
63969	4,25	10,6	5,2	220	1
63970	5,91	12,6	6,0	300	1

Bol

Bol
Bowl
Bowl
Bacia



Ref	€	Ø (cm)	h (cm)	ml	U.Venta
63972	5,40	12,4	4,6	300	1

Bol cónico

Conique bol
Bowl Konisch
Conical bowl
Bacia cónica



Ref	€	Ø (cm)	h (cm)	ml	U.Venta
63946	7,47	15,7	5,9	330	1
63947	9,03	18,3	6,8	560	1
63948	11,93	21,3	7,8	750	1
63949	16,81	24,2	8,8	1350	1

Bol oval

Bol oval
Oval bowl
Oval bowl
Bacia oval



Ref	€	cm	h (cm)	ml	U.Venta
63960	3,84	12x10	4,1	130	1
63971	6,54	16,3x12,3	4,7	220	1
63961	13,18	20,7x16,8	8,0	660	1
63962	20,54	24,2x20,6	9,3	1150	1

Fuente cuadrada

Plateau carrée
Quadratischen platte
Square tray
Travessa quadrado



Ref	€	cm	h (cm)	ml	U.Venta
63957	6,33	12x12	5,0	200	1
63958	13,38	19x19	6,0	370	1
63959	20,75	24x24	6,8	840	1

Bol salsa mini

Bol sauce mini
Bowl sauce mini
Sauce bowl mini
Bacia molho mini



Ref	€	cm	h (cm)	ml	U.Venta
63973	2,49	7,2x7,2	3,0	30	1

CLASSIC

Bandeja rectangular BLACK

Plateau rectangulaire
Serviertablet, rechteckig
Rectangular tray
Bandeja rectangular



Ref	€	cm	h (cm)	U.Venta
63541	7,26	26x16	2	6
63542	12,14	30x22	2	6

Bandeja rectangular WHITE

Plateau rectangulaire
Serviertablet, rechteckig
Rectangular tray
Bandeja rectangular



Ref	€	cm	h (cm)	U.Venta
63531	7,26	26x16	2	6
63532	12,14	30x22	2	6

Bandeja rectangular WHITE

Plateau rectangulaire
Serviertablet, rechteckig
Rectangular tray
Bandeja rectangular



Ref	€	cm	h (cm)	U.Venta
63533	15,77	30x21	3	6
63534	18,57	35x21	2	6

Bandeja rectangular WHITE

Plateau rectangulaire
Serviertablet, rechteckig
Rectangular tray
Bandeja rectangular



Ref	€	cm	h (cm)	U.Venta
63535	31,34	53x32	3	6
63536	45,85	70x30	2	3

Fuente pescado WHITE

Plateau poisson
Fischplatte
Fish tray
Travessa peixe



Ref	€	cm	h (cm)	U.Venta
63589	25,73	57x22	4	1



Una completa gama contemporánea en blanco y negro.
Diseñadas para realzar las creaciones del Chef.

Une gamme complète contemporaine en noir et blanc.
Conçues pour rehausser les créations du Chef.

Eine komplette Serie modernen Teller in schwarz und weiß.
Bringt die Kreationen des Küchenchefs noch besser zur Geltung.

Wide collection contemporary black and white pieces.
Designed to complete the Chef's creations.

Uma completa gama contemporânea em preto e branco.
Pensadas para realçar as criações do chef.

Bandeja rectangular BLACK

Plateau rectangulaire
Serviertablet, rechteckig
Rectangular tray
Bandeja rectangular



Ref	€	cm	h (cm)	U.Venta
63543	15,77	30x21	3	6
63544	19,19	35x21	2	6

Bandeja rectangular BLACK

Plateau rectangulaire
Serviertablet, rechteckig
Rectangular tray
Bandeja rectangular



Ref	€	cm	h (cm)	U.Venta
63545	31,85	53x32	3	6
63546	45,85	70x30	2	3

Fuente pescado BLACK

Plateau poisson
Fischplatte
Fish tray
Travessa peixe



Ref	€	cm	h (cm)	U.Venta
63599	25,73	57x22	4	1

Fuente oval WHITE

Plateau oval
Oval platte
Oval tray
Travessa redonda



Ref	€	cm	h (cm)	L	U.Venta
63557	8,20	32x12	6	0,85	6
63558	13,07	41,5x17	8	2,20	1

Fuente oval BLACK

Plateau oval
Oval platte
Oval tray
Travessa redonda



Ref	€	cm	h (cm)	L	U.Venta
63567	8,20	32x12	6	0,85	6
63568	13,07	41,5x17	8	2,20	6

Bandeja Delicatessen WHITE

Plateau delicatessen
Schüssel delicatessen
Delicatessen tray
Bandeja delicatessen



Ref	€	cm	U.Venta
63609	3,01	9,5x9,5	6

Bandeja Delicatessen BLACK

Plateau delicatessen
Schüssel delicatessen
Delicatessen tray
Bandeja delicatessen



Ref	€	cm	U.Venta
63619	3,01	9,5x9,5	6

Bandeja Delicatessen WHITE

Plateau Delicatessen
Schüssel Delicatessen
Delicatessen tray
Bandeja Delicatessen



Ref	€	cm	h (cm)	L	U.Venta
63610	2,59	10x10	2,5	0,12	6

Bandeja Delicatessen BLACK

Plateau Delicatessen
Schüssel Delicatessen
Delicatessen tray
Bandeja Delicatessen



Ref	€	cm	h (cm)	L	U.Venta
63617	2,59	10x10	2,5	0,12	6

Fuente redonda WHITE

Plateau rond
Rundplatte
Round tray
Travessa redonda



Ref	€	Ø (cm)	h (cm)	U.Venta
63551	24,49	40,0	6,0	6
63552	32,47	44,5	6,5	1

Fuente cuadrada WHITE

Plateau rectangulaire
Serviertablet, rechteckig
Rectangular tray
Travessa cuadrada



Ref	€	cm	h (cm)	L	U.Venta
63573	23,86	33,5x33,5	8,5	5,0	1

Fuente WHITE

Plateau
Serviertablet
Tray
Travessa



Ref	€	Ø (cm)	h (cm)	L	U.Venta
63577	22,41	35,5	11	4,0	6

Portatartas

Guéridon pâtisserie
Kuchenplatte
Cake stand
Porta-tartes



Ref	€	Ø (cm)	h (cm)	U.Venta
63586	27,49	33	9	1

Bol redondo WHITE

Bol rond
Schale rund
Round bowl
Bacia redonda



Ref	€	Ø (cm)	h (cm)	L	U.Venta
63553	13,38	22	10,0	2,4	6
63554	19,71	28	10,0	4,0	6
63555	27,49	33	13,0	7,0	6
63556	34,13	38	14,5	11,0	2

Bol oval WHITE

Bol oval
Schale oval
Oval bowl
Bacia oval



Ref	€	cm	h (cm)	L	U.Venta
63585	20,02	29x26	16	4,0	6

Bol ensalada WHITE

Bac salade
Schüssel
Salad bowl
Bacia de salada



Ref	€	cm	h (cm)	L	U.Venta
63570	6,64	13x13	6	0,5	6
63571	16,70	19x19	9	2,0	1
63572	32,68	25x25	12	4,8	1

Bol ensalada BLACK

Bac salade
Schüssel
Salad bowl
Bacia de salada



Ref	€	cm	h (cm)	L	U.Venta
63580	6,64	13x13	6	0,5	6
63581	16,70	19x19	9	2,0	1
63582	32,68	25x25	12	4,8	1

Ribbed bol

Ribbed bol
Schale gerippt
Bowl Ribbed
Bacia Ribbed



Ref	€	Ø (cm)	h (cm)	L	U.Venta
63611	1,97	7,0	3	0,05	6
63612	2,39	8,5	4	0,10	6

Bandeja oval

Plateau ovale
Servierblech oval
Oval tray
Bandeja oval



Ref	€	cm	h (cm)	U.Venta
62751	3,53	20,7x14,4	1,8	10
62753	5,29	25,0x18,3	2,2	10
62754	5,71	28,0x20,0	2,4	10
62755	6,74	31,4x23,4	2,5	10
62756	8,51	33,5x25,8	2,6	10
62757	9,44	32,6x28,5	2,7	10
62758	12,04	41,2x31,4	2,8	10
62759	13,90	45,8x34,8	3,0	10

Bandeja redonda

Plateau rond
Servierblech rund
Round tray
Bandeja redonda



Ref	€	Ø (cm)	h (cm)	U.Venta
62761	3,63	18,0	2,4	10
62762	4,25	20,0	2,5	10
62764	6,23	25,4	2,9	10
62766	10,27	30,7	3,3	10
62768	12,35	33,5	3,2	10
62769	17,74	40,0	3,5	6

Plato redondo ondulado

Plateau rond ondulé
Rund Teller gewellt
Undulated round plate
Plato redondo ondulado



Ref	€	Ø (cm)	h (cm)	U.Venta
62770	5,40	20,7	2,8	10
62771	9,03	25,0	3,0	1
62772	10,58	29,5	3,1	1

Bandeja rectangular

Plateau rectangulaire
Servierblech, rechteckig
Rectangular tray
Bandeja rectangular



Ref	€	cm	h (cm)	U.Venta
62791	6,12	24,8x16,0	2,3	10
62792	8,82	28,0x19,0	2,3	10
62793	10,05	30,0x20,8	2,3	10

Bol cuadrado

Bac carre
Schüssel, viereckig
Square bowl
Bacia quadrada



Ref	€	cm	h (cm)	L	U.Venta
62780	3,53	12,3x12,3	6,3	0,40	10
62781	4,15	14,9x14,9	7,0	0,70	10
62782	5,19	17,3x17,3	7,9	1,00	10
62783	6,74	19,7x19,7	8,8	1,50	1
62784	8,92	21,5x21,5	9,5	2,00	1

Bol redondo

Bac rond
Schüssel, rund
Round bowl
Bacia redonda



Ref	€	Ø (cm)	h (cm)	L	U.Venta
62785	3,11	11,8	5,1	0,30	10
62786	3,74	12,8	5,7	0,40	10
62787	4,36	14,9	6,5	0,60	10
62790	8,72	20,6	8,8	1,80	10

**Bandeja camarero rectangular**

Plateau limonadier rectangulaire
Serviertablet, rechteckig
Rectangular serving tray
Bandeja de servir rectangular

Ref	€	cm	h (cm)	U.Venta
62797	20,44	43,3x29,3	4,8	1

Cuchara lisa

Cuillère lisse
Servierlöffel
Plain spoon
Colher lisa



Ref	€	cm	U.Venta
63600	0,83	18	6

ABS

Plastic

Pinza multiusos WHITE

Pince à salade
Allzweckzange
Multi-usage tong
Pinça universal



Ref	€	cm	U.Venta
63608	3,01	22,5	6
63638	3,94	30,0	6

ABS

Plastic

Pinza multiusos BLACK

Pince à salade
Allzweckzange
Multi-usage tong
Pinça universal



Ref	€	cm	U.Venta
63618	3,01	22,5	6
63648	3,94	30,0	6

Cacillo recto

Louche sauce
Saucengliessl
Soup ladle
Concha molt



Ref	€	cm	ml	U.Venta
63602	2,49	27	150	6

Cacillo perforado

Louche perforee
Saucengliessl
Slotted ladle
Concha perforada



Ref	€	cm	U.Venta
63605	2,49	27	6

Cuchara recta

Louche plain
Saucengliessl
Plain spoon
Colher lisa



Ref	€	cm	ml	U.Venta
63601	1,56	25	40	6
63604	2,08	30	50	6

Cuchara perforada

Louche perforee
Saucengliessl
Slotted spoon
Colher perforada



Ref	€	cm	U.Venta
63603	1,97	30	6

▶ WHITE & BLACK

Bol cónico BLACK

Conique bol
Schale konisch
Conical bowl
Bacia cónica



Ref	€	Ø (cm)	L	L	U.Venta
63361	8,09	17	7,0	0,70	6
63362	9,75	21	8,0	1,25	6
63363	11,10	25	8,5	1,80	6

Bol cónico WHITE

Conique bol
Schale konisch
Conical bowl
Bacia cónica



Ref	€	Ø (cm)	h (cm)	L	U.Venta
63261	8,09	17	7,0	0,70	6
63262	9,75	21	8,0	1,25	6
63263	11,10	25	8,5	1,80	6

Bol redondo WHITE

Rond bol
Schale rund
Bowl round
Bacia redonda



Ref	€	Ø (cm)	h (cm)	L	U.Venta
63264	6,43	12,5	7,5	0,45	6
63265	7,47	14,0	7,5	0,60	6



Combina formas suaves y orgánicas con un diseño puro y elegante.
Piezas en color BLANCO y NEGRO, únicas y elegantes.

Allie des formes douces et organiques à un style pur et élégant.
Pièces de couleur NOIRE et BLANCHE, uniques et élégantes.

Weilche natürliche Formen samt klarem und elegantem Design.
Einzigartig schön geformte Teile in SCHWARZ und WEISS.

Soft and organic forms are combined with pure, stylish design.
Unique and elegant WHITE and BLACK pieces.

Formas suaves e orgánicas, combinadas com um desenho de linhas puras e elegantes.
Peças em branco e negro, únicas e elegantes.

Bol redondo BLACK

Rond bol
Schale rund
Bowl round
Bacia redonda



Ref	€	Ø (cm)	h (cm)	L	U.Venta
63364	6,43	12,5	7,5	0,45	6
63365	7,47	14,0	7,5	0,60	6

Bol oval WHITE

Bol oval
Oval bowl
Oval bowl
Bacia oval



Ref	€	cm	h (cm)	L	U.Venta
63268	6,54	17x14	6	0,40	6
63269	14,84	24x20	9	1,70	6

Bol oval BLACK

Bol oval
Oval bowl
Oval bowl
Bacia oval



Ref	€	cm	L	L	U.Venta
63368	6,54	17x14	6	0,40	6
63369	14,84	24x20	9	1,70	6

Fuente redonda WHITE

Plateau rond
Rundplatte
Round tray
Travessa redonda



Ref	€	Ø (cm)	h (cm)	L	U.Venta
63267	25,21	31	8	3,0	6

Fuente redonda BLACK

Plateau rond
Rundplatte
Round tray
Travessa redonda



Ref	€	Ø (cm)	h (cm)	L	U.Venta
63367	25,21	31	8	3,0	6

Fuente cuadrada WHITE

Plateau carrée
 Quadratischen platte
 Square tray
 Travessa quadrado



Ref	€	cm	h (cm)	U.Venta
63272	6,23	19x19	4	6
63273	13,49	25x25	5	6

Fuente cuadrada BLACK

Plateau carrée
 Quadratischen platte
 Square tray
 Travessa quadrado



Ref	€	cm	h (cm)	U.Venta
63372	6,23	19x19	4	6
63373	13,49	25x25	5	6

Fuente rectangular WHITE

Plateau rectangulaire
 Serviertablet, rechteckig
 Rectangular tray
 Travessa rectangular



Ref	€	cm	h (cm)	U.Venta
63274	8,09	25x17,5	3	6

Fuente rectangular BLACK

Plateau rectangulaire
 Serviertablet, rechteckig
 Rectangular tray
 Travessa rectangular



Ref	€	cm	h (cm)	U.Venta
63374	8,09	25x17,5	3	6

Fuente oval WHITE

Plateau ovale
 Schale oval
 Oval tray
 Travessa oval



Ref	€	cm	h (cm)	U.Venta
63275	11,31	32x14	4	6

Fuente oval BLACK

Plateau ovale
 Schale oval
 Oval tray
 Travessa oval



Ref	€	cm	h (cm)	U.Venta
63375	11,31	32x14	4	6

Fuente salsa mini WHITE

Plateau sauce mini
 Serviertablet sauce mini
 Sauce tray mini
 Travessa molho mini



Ref	€	cm	h (cm)	U.Venta
63279	3,32	9x7	3	6

Fuente salsa mini BLACK

Plateau sauce mini
 Serviertablet sauce mini
 Sauce tray mini
 Travessa molho mini



Ref	€	cm	h (cm)	U.Venta
63379	3,32	9x7	3	6

Fuente 3 salsas WHITE

Plateau 3 sauces
 Serviertablet 3 sauces
 3 sauces tray
 Travessa 3 molhos



Ref	€	cm	h (cm)	U.Venta
63280	4,67	19x8	3	6

Fuente 3 salsas BLACK

Plateau 3 sauces
 Serviertablet 3 sauces
 3 sauces tray
 Travessa 3 molhos



Ref	€	cm	h (cm)	U.Venta
63380	4,67	19x8	3	6

Bol salsa WHITE

Bac sauce
 Schüssel saucen
 Sauce bowl
 Bacia molho



Ref	€	cm	h (cm)	L	U.Venta
63270	4,98	14x12	5	0,25	6

Bol salsa BLACK

Bac sauce
 Schüssel saucen
 Sauce bowl
 Bacia molho



Ref	€	cm	h (cm)	L	U.Venta
63370	4,98	14x12	5	0,25	6

Fuente cuadrada

Plateau rectangulaire
Serviertablet, rechteckig
Rectangular tray
Travessa quadrada



Ref	€	cm	h (cm)	U.Venta
63161	13,18	22x22	2,5	6
63162	15,36	27,5x27,5	3,0	6

Bandeja rectangular

Plateau rectangulaire
Serviertablet, rechteckig
Rectangular tray
Bandeja rectangular



Ref	€	cm	h (cm)	U.Venta
63163	12,24	29x18	3	6

Bandeja rectangular

Plateau rectangulaire
Serviertablet, rechteckig
Rectangular tray
Bandeja rectangular



Ref	€	cm	h (cm)	U.Venta
63164	18,16	34x21,5	2,5	6

Bandeja rectangular

Plateau rectangulaire
Serviertablet, rechteckig
Rectangular tray
Bandeja rectangular



Ref	€	cm	h (cm)	U.Venta
63165	11,41	25x15	3	6

Fuente oval

Carrée ovale
Schale oval
Oval tray
Travessa oval



Ref	€	cm	h (cm)	L	U.Venta
63166	12,45	25x19	5	0,6	6

Fuente hoja

Pati feuille
Platte, Blatt
Leaf plate
Travessa folha



Ref	€	cm	h (cm)	U.Venta
63176	12,87	37,5x16	4,0	6
63177	18,88	46,5x21	6,5	6



Inspiradas en la cocina oriental.

La armonía entre el Ying y el Yang constituyen el diseño exclusivo de la gama Fuji.

Inspires de la cuisine orientale.

L'harmonie du Ying et du Yang constitue le style exclusif de la gamme Fuji.

Von der asiatischen Küche inspiriert. Das Design der Fuji-Serie ist exklusiv auf Harmonie zwischen Ying und Yang gegründet.

Inspired by oriental cuisine.

The harmony between Ying and Yang forms the exclusive design of the Fuji range.

Inspiradas na cozinha oriental.

A harmonia entre Ying e Yang serve de inspiração ao design exclusivo da gama Fuji.

Fuente lagrима

Plat feuille
Platte, Träne
Tear plate
Travessa lagrима



Ref	€	cm	h (cm)	U.Venta
63175	12,76	34x13	3	6

Bol

Bol
Schale
Bowl
Bacia



Ref	€	Ø (cm)	h (cm)	L	U.Venta
63169	20,54	26	8	2,2	6

Bol oval

Ovale bol
Schale oval
Oval tray
Bacia oval



Ref	€	cm	h (cm)	L	U.Venta
63171	8,20	18x13,5	6	0,5	6
63172	13,18	24x17,5	6	1,0	6

Bol oval

Ovale bol
Schale oval
Oval tray
Bacia oval



Ref	€	cm	h (cm)	U.Venta
63173	5,71	14x8	4	6
63174	6,12	15x10	4	6

Cuchara snack

Cuillère snack
Löffel snack
Snack spoon
Colher snack



Ref	€	cm	h (cm)	U.Venta
63178	3,74	14,5x14,5	4,5	6



Fabricadas en melamina de alta calidad. Libre de BPA.
 Combinan formas naturales con aspecto elegante parecido al mármol.
 Diseñadas para realzar las creaciones del Chef.
 Ligeras, resistentes a golpes y choques térmicos.
 Higiénicas y fácilmente lavables, aptas para lavavajillas.

Produits fabriqués en mélamine de grande qualité. Sans BPA.
 Ils allient des formes naturelles à un aspect élégant semblable au marbre.
 Conçus pour réaliser les créations du Chef.
 Légers, résistants aux chocs et aux variations thermiques.
 Hygiéniques et faciles à laver, aptes pour le lave vaisselle.

Aus hochwertigen Melamin. Ohne BPA.
 Elegante und natürliche Formen mit Marmorierung.
 Bringt die Kreationen des Küchenchefs noch besser zur Geltung.
 Leicht, stoßfest, Widerstandsfähig gegen abrupte Temperaturwechsel.
 Hygienisch und leicht zu reinigen. Spülmaschinengeeignet.

Made of high quality melamine. BPA free.
 They combine natural forms with an elegant appearance that looks like marble.
 Designed to highlight the Chef's creations.
 Lightweight and resistant to impacts and thermal shock.
 Hygienic, easy to wash and dishwasher safe.

Fabricadas em melamina de alta qualidade, sem BPA.
 Combinam as formas naturais com um aspeto elegante, a imitar o mármore.
 Destinadas para realçar as criações do Chef.
 Leves, resistentes aos golpes e aos choques térmicos.
 Higiénicas e fáceis de lavar, aptas para máquinas de lavar louça.



Plato redondo

Plateau rond
 Rund Plate
 Round plate
 Prato redondo

Ref	€	Ø (cm)	h (cm)	U.Venta
63180	29,57	35	3,0	1
63181	45,15	44	3,0	1
63182	67,54	55	3,0	1



Fuente oval

Carrée ovale
 Schale oval
 Oval tray
 Travessa oval

Ref	€	cm	h (cm)	U.Venta
63183	38,70	65x25	3,0	1



Fuente huevo

Plat oeufs
 Eierplatte
 Egg plate
 Travessa ovo

Ref	€	cm	h (cm)	U.Venta
63184	28,95	40,7x30,5	4,3	1



Tabla con mango

Planche avec manche
 Servierbrett mit Griff
 Board with grip
 Tabua com mango

Ref	€	cm	h (cm)	U.Venta
63185	19,71	40x19,5	0,9	1
63186	27,08	46x25	0,9	1



Bandeja cuadrada

Plateau carrée
Quadratischen platte
Square tray
Travessa quadrado

Ref	€	cm	h (cm)	U.Venta
63187	21,37	28,5x28,5	0,9	1



Bandeja rectangular

Plateau rectangulaire
Serviertablet, rechteckig
Rectangular tray
Bandeja rectangular

Ref	€	cm	h (cm)	U.Venta
63188	25,73	35x28,5	0,9	1
63189	32,68	43x28,5	0,9	1
63190	48,14	53x32	0,9	1



Fuente hoja

Pati feuille
Bratt platte
Leaf plate
Travessa folha

Ref	€	cm	h (cm)	U.Venta
63191	18,05	40x25,3	4,3	1
63192	32,06	53x33	4,3	1

PIZARRA

Aspecto de pizarra natural
Natural slates appearance



Fuente Pizarra

Plateau ardoise
Tafelplatte Schiefer
Slate tray
Travessa de ardósia

Ref	€	cm	h (cm)	U.Venta
63461	18,57	28x28	1	6
63462	23,34	35x28	1	6
63463	28,12	43x28	1	6

► MAGMA MELAMINA

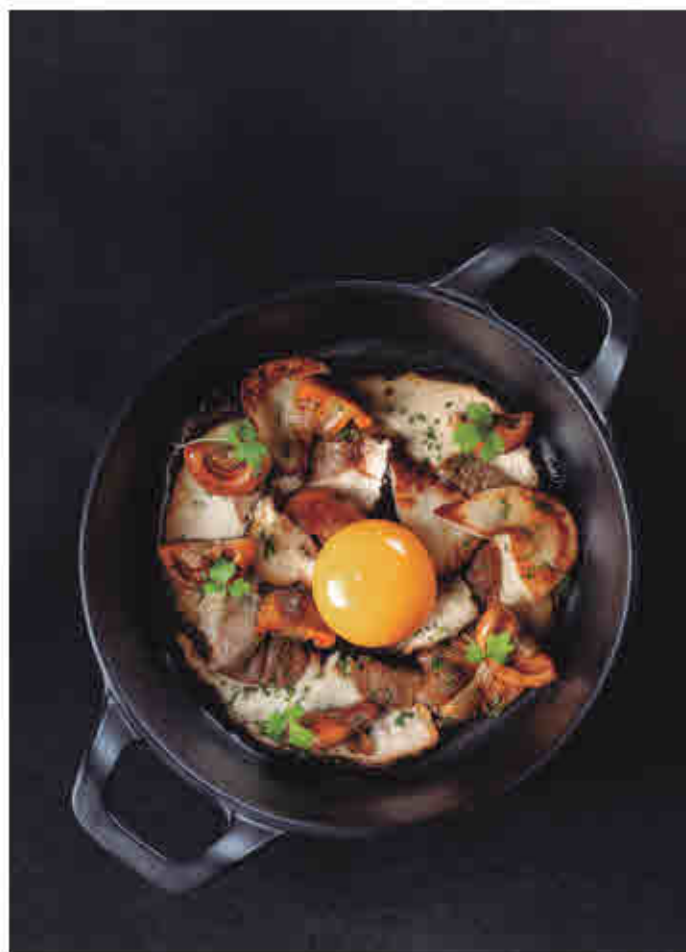

Fabricadas en melamina de alta calidad.
Ofrecen un aspecto muy natural parecido al hierro fundido.
Ideal para servir y presentar los platos más exquisitos.

Fabriqué en mélamine de haute qualité.
Aspect très naturel, semblable à la fonte d'aluminium.
Idéale pour servir et présenter les plats les plus exquis.

Hergestellt aus hochwertigem Melamin.
Sehr natürliches Aussehen, ähnlich wie Gusseisen.
Ideal zum Servieren und Anrichten erlesener Gerichte.

Made of high quality melamine.
Very natural appearance similar to cast iron.
Perfect for serving and presenting the most exquisite dishes.

Fabricado em melamina de alta qualidade.
Aspecto natural similar ao ferro fundido.
Ideal para servir e apresentar os pratos mais exquisitos.

Cacerola redonda

Faitout rond
Rund Bratentopf
Round casserole
Caçarola redonda

Ref	€	Ø (cm)	U.Venta
63384	4,25	16	12
63385	5,29	18	12



Cacerola oval

Faitout ovale
Oval Bratentopf
Oval casserole
Caçarola oval

Ref	€	cm	U.Venta
63386	3,84	18x12	12
63389	4,88	21x15	12



Wok

Wok
Wok
Wok
Wok

Ref	€	Ø (cm)	U.Venta
63386	3,63	15	12
63387	4,98	18	12



Mini Grill

Mini Grill
Mini Grill
Mini Grill
Mini Grill

Ref	€	cm	U.Venta
63382	6,23	13,5x13,5	6



Mini sartén

Mini poêle
Mini Pfanne
Mini frying pan
Mini sertã

Ref	€	Ø (cm)	U.Venta
63381	5,91	15	6



Mini sartén rectangular

Mini poêle rectangulaire
Mini Pfanne, rechteckiger
Rectangular Mini frying pan
Mini sertã rectangular

Ref	€	cm	U.Venta
63383	4,25	17x11,5	12



► CUBETAS GN WHITE & BLACK



Ligeros, indeformables y apilables.
Higiénicos y fácilmente lavables.
Aptos para procesos de refrigeración, congelación o distribución de alimentos.

Légères, indéformables et empilables.
Hygiéniques et facilement lavables.
Compatibles pour des processus de réfrigération, congélation ou distribution d'aliments.

Leicht, nicht verformbar und stapelbar.
Hygienisch und einfach zu reinigen.
Geeignert für Kühl-, Gefriervorgänge, Mikrowellenherde oder Nahrungsmittelverteilung.

Light, non-deformable and stackable.
Hygienic and easily washable.
Suitable for refrigeration and freezing processes and food distribution.

Leves, indeformáveis e empilháveis.
Higiénicos e facilmente laváveis.
Aptos para processos de refrigeração, congelação ou distribuição de alimentos.



Cubeta 1/1
 Bac 1/1
 GN-Behälter 1/1
 Container 1/1
 Caixa 1/1

Ref	€	h (mm)	L	U.Venta
66165E	37,35	65	8,50	1
66110E	42,43	100	13,30	1



Cubeta 1/1
 Bac 1/1
 GN-Behälter 1/1
 Container 1/1
 Caixa 1/1

Ref	€	h (mm)	L	U.Venta
66165J	39,74	65	8,50	1
66110J	44,72	100	13,30	1

1/1
 500 x 325 mm



Cubeta 1/2
 Bac 1/2
 GN-Behälter 1/2
 Container 1/2
 Caixa 1/2

Ref	€	h (mm)	L	U.Venta
66265E	19,51	65	4,50	1
66210E	21,68	100	8,00	1



Cubeta 1/2
 Bac 1/2
 GN-Behälter 1/2
 Container 1/2
 Caixa 1/2

Ref	€	h (mm)	L	U.Venta
66265J	20,34	65	4,50	1
66210J	23,03	100	8,00	1

1/2
 265 x 325 mm

1/3
176 x 325 mm

Cubeta 1/3

Bac 1/3
GN-Behälter 1/3
Container 1/3
Caixa 1/3



Ref	€	h (mm)	L	U.Venta
66365E	15,15	65	2,50	1
66310E	16,91	100	3,80	1

Cubeta 1/3

Bac 1/3
GN-Behälter 1/3
Container 1/3
Caixa 1/3



Ref	€	h (mm)	L	U.Venta
66365J	16,29	65	2,50	1
66310J	18,05	100	3,80	1

1/4
265 x 182 mm

Cubeta 1/4

Bac 1/4
GN-Behälter 1/4
Container 1/4
Caixa 1/4



Ref	€	h (mm)	L	U.Venta
66465E	13,07	65	1,90	1
66410E	14,73	100	2,50	1

Cubeta 1/4

Bac 1/4
GN-Behälter 1/4
Container 1/4
Caixa 1/4



Ref	€	h (mm)	L	U.Venta
66465J	13,90	65	1,90	1
66410J	15,77	100	2,50	1

2/3
350 x 325 mm

Cubeta 2/3

Bac 2/3
GN-Behälter 2/3
Container 2/3
Caixa 2/3



Ref	€	h (mm)	L	U.Venta
66565E	28,12	65	5,50	1

Cubeta 2/3

Bac 2/3
GN-Behälter 2/3
Container 2/3
Caixa 2/3



Ref	€	h (mm)	L	U.Venta
66565J	29,36	65	5,50	1

1/6
176 x 182 mm

Cubeta 1/6

Bac 1/6
GN-Behälter 1/6
Container 1/6
Caixa 1/6



Ref	€	h (mm)	L	U.Venta
66665E	9,34	65	1,10	1
66610E	10,48	100	1,60	1

Cubeta 1/6

Bac 1/6
GN-Behälter 1/6
Container 1/6
Caixa 1/6



Ref	€	h (mm)	L	U.Venta
66665J	9,96	65	1,10	1
66610J	11,31	100	1,60	1

2/4
350 x 185 mm

Cubeta 2/4

Bac 2/4
GN-Behälter 2/4
Container 2/4
Caixa 2/4



Ref	€	h (mm)	L	U.Venta
66765E	19,61	65	4,50	1

Cubeta 2/4

Bac 2/4
GN-Behälter 2/4
Container 2/4
Caixa 2/4



Ref	€	h (mm)	L	U.Venta
66765J	20,23	65	4,50	1

Servicio Mesa
Table Service
#CocinaConLacor



▶ MANTELES DE MESA

New



Se pueden personalizar en seco
Can be customized in dry

Cuero
Leather



Fabricados en cuero 100% reciclado. Espesor de 1,5 y 2,1 mm.
Disponibles en tres formatos; cuadrado, redondo y forma oval.
Resistentes a altas temperaturas y manchas | Aislantes del calor | Impermeables.
Se limpian fácilmente con solución hidroalcohólica sin dañar el producto.
Perfectos para vestir y proteger las mesas de restaurantes, cafeterías y hasta el propio hogar.

Fabriqués en cuir 100% recyclé. Épaisseur de 1,5 et 2,1 mm.
Disponibles en trois formats : carré, rond et forme ovale.
Résistants aux hautes températures et aux taches | Isolants de la chaleur | Imperméables.
Se nettoient facilement avec un chiffon humide, du désinfectant, etc.
Parfaits pour habiller et protéger les tables des restaurants, des cafés et même pour un usage domestique.

Aus 100 % Recycling-Leder. 1,5-2,1 mm dick.
Erhältlich in drei Formaten: Viereck, Kreis und oval.
Beständig gegen hohe Temperaturen und Flecken | Wärmedämmend | Wasserdicht.
Einfache Reinigung mit feuchtem Lappen, Desinfizierer usw.
Ideal als Tischabdeckung und -schutz für Restaurants, Cafés und auch für Zuhause.

Made of 100% recycled leather. 1,5 mm and 2,1 mm Thickness.
Available in three formats: square, round and oval shaped.
Resistant to high temperatures and stains | Heat insulating | Waterproof.
Easy to clean with a damp cloth, disinfectant, etc.
Perfect for decorating and protecting tables in restaurants, cafés and even at home.

Fabricados em couro 100% reciclado. Espessura de 1,5 e 2,1 mm.
Disponíveis em três formatos; quadrado, redondo e forma oval.
Resistentes às altas temperaturas e às manchas | Isolantes do calor | Impermeáveis.
Limpa-se facilmente com um pano húmido, desinfetante, etc.
Perfeitos para cobrir e proteger as mesas de restaurantes, cafeterias e para uso doméstico.



Mantel individual rectangular
Nappe individuelle rectangulaire
Tischset, rechteckiger
Rectangular individual placemat
Toalhas de mesa individual rectangular

	Ref.	€	cm	e (mm)	Color	U.Venta	
A	66831	17,53	45x30	1,5	Marrón / Brown	1	Milón
B	66832	17,53	45x30	1,5	Antracita / Anthracite	1	Cróna
C	66833	18,16	45x30	2,1	Marrón granulado / Grained brown	1	Rinia
D	66834	18,16	45x30	2,1	Negro granulado / Grained Black	1	Cos



Mantel individual oval

Nappe individual ovale

Tischset, oval

Oval individual placemat

Toalhas de mesa individual oval

	Ref	€	cm	e (mm)	Color	U.Venta	
A	66839	18,99	45x35	1,5	Marrón / Brown	1	Milos
B	66840	18,99	45x35	1,5	Antracita / Anthracite	1	Creta
C	66841	19,92	45x35	2,1	Marrón granulado / Grained brown	1	Rinia
D	66842	19,92	45x35	2,1	Negro granulado / Grained Black	1	Cos

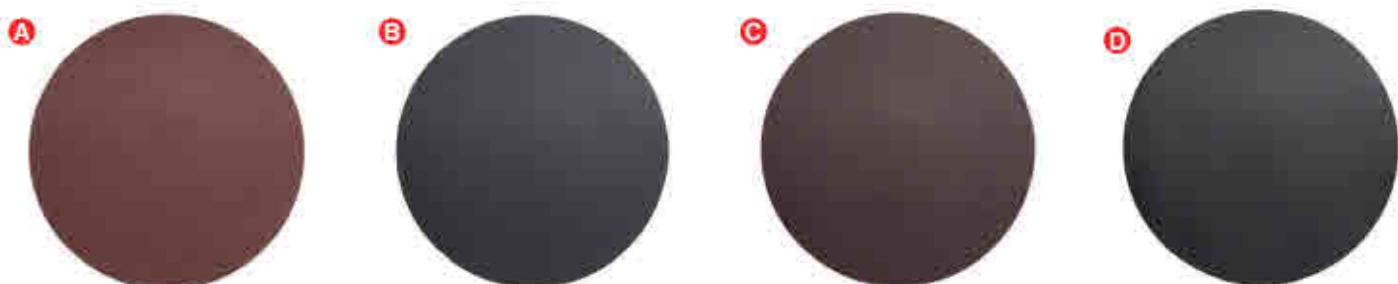

Mantel individual redondo

Nappe individual rond

Tischset, rund

Round individual placemat

Toalhas de mesa individual redondo

	Ref	€	Ø (cm)	e (mm)	Color	U.Venta	
A	66835	20,65	40	1,5	Marrón / Brown	1	Milos
B	66836	20,65	40	1,5	Antracita / Anthracite	1	Creta
C	66837	21,68	40	2,1	Marrón granulado / Grained brown	1	Rinia
D	66838	21,68	40	2,1	Negro granulado / Grained Black	1	Cos



Set de 4 posavazos

Jeu 4 dessous de verre

4-Tlg. Untersetzer

Set 4 coasters

Set 4 bases para copos

	Ref	€	Ø (cm)	e (mm)	Color	U.Venta	
A	66850	11,31	10	1,5	Marrón / Brown	1	Milos
B	66851	11,31	10	1,5	Antracita / Anthracite	1	Creta
C	66852	12,35	10	2,1	Marrón granulado / Grained brown	1	Rinia
D	66853	12,35	10	2,1	Negro granulado / Grained Black	1	Cos



Set de 4 servilleteros

Jeu 4 ronds de serviettes

Set 4 serviettenringe

Set 4 napkin rings

Set 4 anéis de guardanapos

	Ref	€	cm	e (mm)	Color	U.Venta	
A	66854	8,30	3x16,5	1,5	Marrón / Brown	1	Milos
B	66855	8,30	3x16,5	1,5	Antracita / Anthracite	1	Creta
C	66856	9,03	3x16,5	2,1	Marrón granulado / Grained brown	1	Rinia
D	66857	9,03	3x16,5	2,1	Negro granulado / Grained Black	1	Cos





Fabricados en 75% PVC + 25% Polyester

Fait de 75% PVC + 25% Polyester
 Hergestellt aus 75% PVC + 25% Polyester
 Made of 75% PVC + 25% Polyester
 Feita de 75% PVC + 25% Polyester



Mantel individual

Nappe individuel
 Tischset
 Individual placemat
 Toalha de mesa individual

	Ref	€	cm	U.Venta	
A	66772	4.25	45x30	6	LANTA
B	66773	4.25	45x30	6	KOTAO
C	66780	4.15	45x30	6	SUMBA
D	66781	4.15	45x30	6	BIAK
E	66782	4.15	45x30	6	GILI
F	66783	4.15	45x30	6	RINCA



Fabricados en 75% PVC + 25% Polyester

Fait de 75% PVC + 25% Polyester
 Hergestellt aus 75% PVC + 25% Polyester
 Made of 75% PVC + 25% Polyester
 Feita de 75% PVC + 25% Polyester



Camino de mesa

Chemin de table
 Tischläufer
 Table runner
 Corte mesa

	Ref	€	cm	U.Venta	
A	66790	9.23	40x140	1	BORNEO
B	66791	9.23	40x140	1	MANGOLE
C	66792	9.23	40x140	1	SIPURA
D	66793	9.23	40x140	1	TIMOR

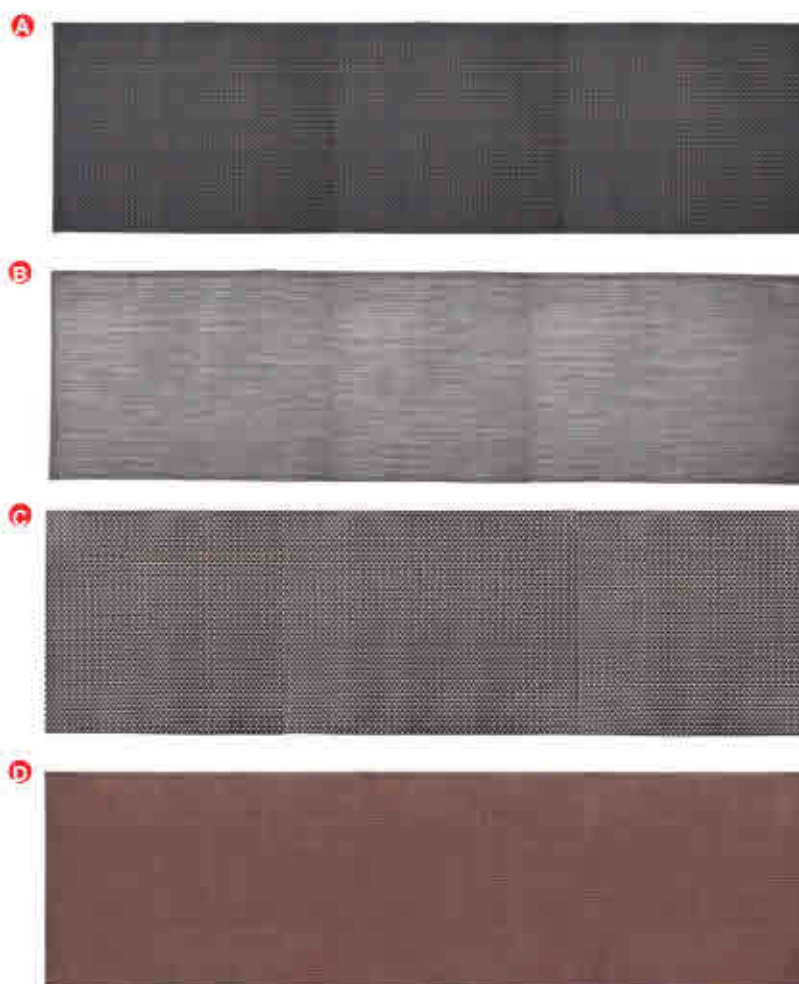

Fabricados en 75% PVC + 25% Polyester

Fait de 75% PVC + 25% Polyester
 Hergestellt aus 75% PVC + 25% Polyester
 Made of 75% PVC + 25% Polyester
 Feita de 75% PVC + 25% Polyester

**Mantel individual**

Nappe individuel
 Tischset
 Individual placemat
 Toalha de mesa individual



	Ref	€	cm	U.Venta	
A	66755	3,74	45x30	6	SAMUI
B	66756	3,74	45x30	6	KRABI
C	66757	3,74	45x30	6	TAPU
D	66758	3,74	45x30	6	SAMET

Fabricados en PVC 100%

Fait de 100% PVC
 Hergestellt aus 100% PVC
 Made of 100% PVC
 Feita de 100% PVC

**Mantel individual**

Nappe individuel
 Tischset
 Individual placemat
 Toalha de mesa individual



	Ref	€	cm	U.Venta	
A	66784	6,02	45x30	6	MASBATE
B	66785	6,02	45x30	6	LEYTE

Fabricados en PVC 100%

Fait de 100% PVC
 Hergestellt aus 100% PVC
 Made of 100% PVC
 Feita de 100% PVC

**Mantel individual**

Nappe individuel
 Tischset
 Individual placemat
 Toalha de mesa individual



	Ref	€	cm	U.Venta	
A	66787	6,02	45x30	6	DAVAO
B	66788	6,02	45x30	6	TICAO

SALVAMANTELES



Originales salvamanteles, resistentes y duraderos.
Ideales para colocar sartenes, cazos y otros artículos calientes.

Dessous de plats originaux, résistants et durables.
Parfaits pour y poser des poêles, des casseroles et d'autres ustensiles chauds.

Originelle Untersätze. Haltbar und strapazierfähig.
Ideal zum Abstellen von Pfannen, Kasserollen und anderen heißen Gegenständen geeignet.

Original trivets, resistant and durable.
Ideal for placing frying pans, saucepans and other hot items on.

Originalis bases, resistentes e duráveis.
Ideais para colocar sartens, caçarolas e outros artigos quentes.



12,5x12,5 cm closed

Inox | SI | 200°C
Silicone | max

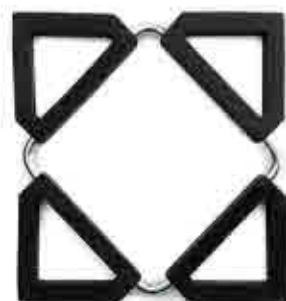

Salvamanteles silicona desplegable

Dessous de plats en silicone déplié
Untersatz

Silicone trivet foldable

Protector de toalhas em silicone dobrável

Ref	€	cm	U.Venta
66752	9,75	16x16	1

FE

Steel



Salvamanteles cuadrado

Dessous de plats carré

Untersatz, viereckig

Square trivet protector

Protector de toalhas quadrado

Ref	€	cm	h (cm)	Varilla (mm)	U.Venta
61129	11,31	18,5x18,5	2,9	5x3	1
61130	14,63	25x25	2,9	5x3	1

Inox

18/10

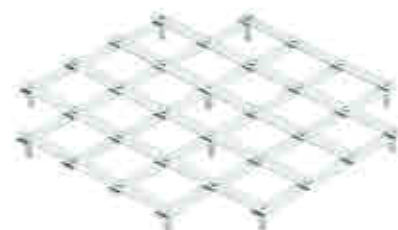

Salvamanteles

Dessous de plats

Untersatz

Trivet protector

Protector de toalhas

Ref	€	cm	h (cm)	U.Venta
63008	15,87	23x23	2,5	1

FE

Steel



Salvamanteles rectangular

Dessous de plats rectangulaire

Untersatz, rechteckiger

Rectang. trivet protector

Protector de toalhas rectangular

Ref	€	cm	h (cm)	Varilla (mm)	U.Venta
61131	14,63	30x20	2,9	5x3	1
61132	20,02	40x25	2,9	5x3	1

Inox



Salvamanteles redondo

Dessous de plats rond

Untersatz rund

Round trivet protector

Protector de toalhas redondo

Ref	€	cm	h (cm)	U.Venta
63036	14,11	20x18	2	1

▶ FRUTEROS · PANERAS



FE

Steel

Originales fruteros muy decorativos fabricados en alambre de acero, acabado en negro mate.

Resistentes y duraderos.

Se pueden usar para almacenar fruta, pan, verduras, huevos, etc.

Corbeilles à fruits originales et très décoratives fabriquées en fil d'acier avec une finition noire mate.

Résistantes et durables.

Pouvent être utilisées pour y déposer des fruits, du pain, des légumes, des œufs, etc.

Originelle und sehr dekorative Drahtkörbe aus Stahlrohr mit mattschwarzer Oberfläch.

Haltbar und strapazierfähig.

Körbe zum Aufbewahren von Obst, Brot, Gemüse, Eiern usw.

Highly decorative original fruit bowls made of steel wire with a matte black finish.

Resistant and durable.

Can be used for storing fruit, bread, vegetables, eggs, etc.

Originales fruteros decorativos, fabricados em arame de aço. Acabamento preto mate.

Resistentes e duráveis.

Para armazenar fruta, pão, verduras, ovos, etc.



Frutero varillas

Corbeille à fruits

Obstschale aus Gitterstäben

Rod fruit bowl

Cesto de metal para fruta

	Ref	€	Ø (cm)	h (cm)	ØVarilla (mm)	U.Venta
A	61126	19.40	23,4	25,4	4	2
B	61127	17,53	27,0	13,8	4	1
C	61128	18,57	34,0	9,5	4	1

Madera contrachapada color haya

Plywood beech color



Frutero varillas

Corbeille à fruits

Obstschale aus Gitterstäben

Square fruit bowl

Cesto de metal para fruta

	Ref	€	Cesta (cm)	h Total (cm)	ØVarilla (mm)	U.Venta
A	61137	29,05	26x26x18,3	27,8	4	1
B	61138	29,05	Ø25,2x17,7	28,9	4	1

Madera Aglomerada Agglomerated Wood



Frutero varillas redondo bajo

Corbeille à fruits ronde basse

Obstschale aus Gitterstäben

Round low rod fruit bowl

Cesto de metal para fruta redondo baixo

	Ref	€	Cesta (cm)	h (cm)	Ø Base (mm)	ØVarilla (mm)	U.Venta
	61139	33,51	Ø39x6	7,6	31,3	4	1

Madera
Caucho
Rubber Wood

Frutero varillas DUAL

Corbeille à fruits
Obstschale aus Gitterstäben
Rod fruit bowl
Cesto de metal para fruta



Ref	€	Grande (cm)	Peq. (cm)	h (cm)	ØVarilla (mm)	U.Venta
61140	45,13	Ø40x10	Ø24x10	63	4	1

Inox

Frutero - Panero Inox.

Panier à fruit et à pain
Brot-/Obstschale
Fruits and bread basket
Frutero-Cesto



Ref	€	Ø (cm)	U.Venta
61821	6,23	20	1
61823	9,44	24	1



Cesta de pan redonda

Corbeille à pain ronde
Brotkorb, rund
Round bread basket
Cesta de pão redonda

A		B				
Ref	€	Ref	€	Ø (cm)	h (cm)	U.Venta
63471	6,64	63871	5,74	19	8	1
63472	7,37	63872	7,37	21	8	1
63473	7,89	63873	7,89	23	8	1
63474	8,40	63874	8,51	26	8	1



Diseñadas para uso intensivo.
Elaboradas a mano.
Acabado en mate.
Alta resistencia y durabilidad.
Apilables.

Conçu pour une utilisation intensive.
Fait à la main.
Fini mat.
Haute résistance et la durabilité.
Empilable.

Auswahl für den intensiven Gebrauch.
Handgemacht.
Matte Oberfläche entwickelt.
Hohe Festigkeit und Haltbarkeit.
Sapelbar.

Designed for intensive use.
Handmade.
Matte finish.
High strength and durability.
Stackable.

Projetado para uso intensivo.
Feito à mão.
Acabamento fosco.
Alta resistência e durabilidade.
Apilável.



Cesta de pan oval

Corbeille à pain ovale
Brotkorb, Oval
Oval bread basket
Cesta de pão oval

A		B				
Ref	€	Ref	€	cm	h (cm)	U.Venta
63480	6,02	63880	6,02	19x14	8,0	1
63481	7,16	63881	7,06	24x17	8,0	1
63482	8,72	63882	8,72	28x16	8,5	1



Cesta de pan
Corbeille à pain
Brotkorb
Bread basket
Cesta de pão

A		B			
Ref	€	Ref	€	Ø (cm)	U.Venta
63494	25,73	63894	25,42	35x20	1



Cesta de pan cuadrada
Corbeille à pain carré
Brotkorb, vierckig
Square bread basket
Cesta de pão quadrada

A		B			
Ref	€	Ref	€	cm	U.Venta
63490	29,57	63890	29,26	53x33,5x9	1

▶ PANERAS NATURA



Panera Marrón NATURA

Corbeille à pain en marron
Brotbeutel, braun
Brown bread basket
Cesto para o pão de Castanho

	Ref	€	cm	h max (cm)	h min (cm)	U.Venta
A	63476	11,93	10x10	25	8	1
B	63477	12,66	12x12	25	12	1
C	63478	14,32	15x15	25	12	1
D	63479	16,50	20x20	33	12	1



Panera Negra NATURA

Corbeille à pain en noir
Brotbeutel, schwarz
Black bread basket
Cesto para o pão de Preto

	Ref	€	cm	h max (cm)	h min (cm)	U.Venta
A	63486	11,93	10x10	25	8	1
B	63487	12,66	12x12	25	12	1
C	63488	14,32	15x15	25	12	1
D	63489	16,50	20x20	33	12	1



Fabricadas en fibra virgen natural.
Material ecológico y respetuoso con el medio ambiente.
Lavables, resistentes y duraderas.
Diseñadas y fabricadas en España.
Hechas a mano.
Tacto agradable y suave, similar a la piel.
Espesor 0,55 mm.

Fabriquées en fibres vierges naturelles.
Matériau écologique et respectueux de l'environnement.
Lavables, résistantes et durables.
Conçues et fabriquées en Espagne.
Faites à la main.
Toucher agréable et doux, similaire au cuir.
Épaisseur de 0,55 mm.

Aus reiner Naturfaser.
Umweltverträgliches Öko-Material.
Waschbar, robust und langlebig.
Design und Herstellung in Spanien.
Handgefertigt.
Weich und angenehm wie Leder.
0,55 mm dick.

Made of natural virgin fibre.
Ecological material respectful with the environment.
Washable, resistant and durable.
Designed and manufactured in Spain.
Handmade.
Nice soft feel, similar to leather.
Thickness 0.55 mm.

Fabricados em fibra virgem natural.
Material ecológico, respeitador do meio ambiente.
Laváveis, resistentes e duráveis.
Desenhados e fabricados em Espanha.
Fabricados à mão.
Tato agradável e suave, similar ao do couro.
Espessura 0.55 mm.

►COCOTTES



Fabricadas en aluminio fundido.

Garantizan la absorción y distribución uniforme del calor, sin puntos de sobrecalentamiento.

La distribución del calor uniforme por toda la pieza hace que los alimentos no pierdan su jugo durante la cocción, conservando así todos sus nutrientes y vitaminas.

Las puntas situadas bajo la tapa, hacen que las gotas fruto de la condensación, vuelvan a caer sobre los alimentos formando un flujo circulante y permanente reduciendo la pérdida de sabores y jugos de los alimentos.

Es la pieza perfecta para: arroces, carnes, pescados, legumbres, verduras, guisos, cremas, salsas, sopas, etc.

Revestimiento antiadherente interior ILAG-ULTIMATE.

Diseño atractivo y funcional.

Fabricade en fonte d'aluminium.

Garantí l'absorption et la distribution uniforme de la chaleur, sans points de surchauffe.

La distribution de la chaleur uniforme sur toute la pièce permet aux aliments de ne pas perdre leur jus pendant la cuisson, conservant ainsi tous leurs nutriments et vitamines.

Les pointes situées sous le couvercle permettent aux gouttes issues de la condensation de retomber sur les aliments, formant ainsi un flux permanent de circulation qui réduit la perte des saveurs et des jus des aliments.

C'est la pièce parfaite pour : riz, viandes, poissons, légumes, ragoûts, crèmes, sauces, soupes, etc.

Revêtement antiadhésif intérieur ILAG-ULTIMATE.

Style attractif et grande fonctionnalité.

Made in cast aluminium.

It guarantees the absorption and uniform distribution of heat, without overheating points.

The uniform distribution of heat throughout the product makes keep its juices during cooking, preserving all its nutrients and vitamins.

The points located under the lid cause the condensation drops to fall back onto the food, forming a permanent and circulating flow and reducing the loss of the food's flavours and juices.

This is an ideal product for: rice, meats, fish, beans, vegetables, stews, creams, sauces, soups, etc.

Interior non-stick coating: ILAG-ULTIMATE.

Attractive design and great functionality.

Cacerola con tapa MINI
Faitout avec couvercle "MINI"
"MINI" Bratentopf mit Deckel
"MINI" round casserole with lid
Çaçarola com tampa "MINI"



Ref	€	Ø (cm)	h (cm)	L	U.Venta
25909	19,51	10	5,0	0,24	1
25914	28,74	14	7,5	0,90	1

Cacerola con tapa MINI negra
Faitout avec couvercle MINI noir
"MINI" Bratentopf mit Deckel, grau
"MINI" black round casserole with lid
Çaçarola com tampa MINI negra



Ref	€	Ø (cm)	h (cm)	L	U.Venta
25910	19,51	10	5,0	0,24	1
25915	28,74	14	7,5	0,90	1

Cacerola oval con tapa MINI
Faitout Ovale avec couvercle "MINI"
"MINI" Oval Bratentopf mit Deckel
"MINI" oval round casserole with lid
Çaçarola oval com tampa "MINI"



Ref	€	cm	h (cm)	L	U.Venta
25911	20,54	12x8,5	5,0	0,25	1

Cacerola oval con tapa MINI negra
Faitout ovale avec couvercle MINI noir
"MINI" Oval Bratentopf mit Deckel, grau
"MINI" black oval round casserole with lid
Çaçarola oval com tampa MINI negra



Ref	€	cm	h (cm)	L	U.Venta
25912	19,40	12x8,5	5,0	0,25	1

NOTA: Más medidas e información en la página 56 - NOTE: More Measures and Information on page 56

HINWEIS : In Deutschland nicht verfügbar

► MAGMA GREY & RED



Acabado exterior e interior esmaltado, muy resistente y de gran durabilidad. Muy versátiles: ideal para cocinar asados, arroces, pasta, cocer a fuego lento e incluso hornear tartas dulces y pan. Conserva todos los nutrientes, vitaminas y sabores de los alimentos. Excelente retención y distribución uniforme del calor. Incluye base de madera, ideal para servir y presentar. Aptas para todo tipo de fuegos.

Finition extérieure et intérieure émaillée. Email très résistant et d'une grande durabilité. Très versatile. Idéal pour cuisiner des ragouts, du riz, des pâtes, cuire à feu doux et même enfourner des gâteaux et du pain. Conserve tous les nutriments, les vitamines et les saveurs des aliments. Excellente rétention et distribution uniforme de la chaleur. Inclut une base en bois, idéale pour servir et présenter. Aptes pour tous types de feux.

Emailierte Außen- und Innenflächen. Sehr beständige und langlebige Emailierung. Sehr vielseitig. Ideal zum Kochen, Braten und Garen, zum Bereiten von Nudeln und Reis und sogar zum Kuchen und Brot backen. Erhält Nährstoffe, Vitamine und Geschmack der Nahrungsmittel. Äußerst gleichmäßige Wärmeaufnahme und -verteilung. Inkl. Holzuntersatz. Ideal zum Servieren und Anrichten. Für alle Herdarten geeignet.

Enamel finish inside and outside. Very strong and durable enamel. Extremely versatile: perfect for roasts, rice, pasta, low heat cooking and even baking bread or cake. Preserves all the nutrients, vitamins and flavours of the food. Excellent heat retention and uniform heat distribution. Wooden base included, perfect for serving or presentation. Appropriate for all kinds of cookers.

Acabamento exterior e interior esmaltado, muito resistente e de grande durabilidade. Grande versatilidade: ideal para cozinhar assados, arroz, massas, cocção a fogo lento e inclusive para cozer no forno tartas doces e pão. Conserva todos os nutrientes, vitaminas e sabores dos alimentos. Excelente retenção e distribuição uniforme do calor. Inclui base de madeira, ideal para servir e apresentar. Aptas para todo o tipo de fogões.

Cacerola redonda GREY

Faitout rond
Rund Bratentopf
Round casserole
Caçarola redonda



Ref	€	Ø (cm)	h (cm)	ml	U.Venta
25841	15,25	12,0	3,0	200	1
25848	23,66	16,2	3,0	470	1
25849	29,47	18,5	3,0	720	1

Cacerola redonda RED

Faitout rond
Rund Bratentopf
Round casserole
Caçarola redonda



Ref	€	Ø (cm)	h (cm)	ml	U.Venta
25851	15,25	12,0	3,0	200	1
25858	23,66	16,2	3,0	470	1
25859	29,47	18,5	3,0	720	1

Cacerola oval GREY

Faitout ovale
Oval Bratentopf
Oval casserole
Caçarola oval



Ref	€	cm	h (cm)	ml	U.Venta
25842	20,34	17,5x12,5	3,0	250	1
25840	29,36	21,7x15	3,0	700	1

Cacerola oval RED

Faitout ovale
Oval Bratentopf
Oval casserole
Caçarola oval



Ref	€	cm	h (cm)	ml	U.Venta
25852	20,34	17,5x12,5	3,0	250	1
25850	29,36	21,7x15	3,0	700	1

Sartón GREY

Poêle
Pfanne
Frying pan
Sertâ



Ref	€	Ø (cm)	h (cm)	ml	U.Venta
25843	15,36	13,5	3,0	275	1

Sartón RED

Poêle
Pfanne
Frying pan
Sertâ



Ref	€	Ø (cm)	h (cm)	ml	U.Venta
25853	15,36	13,5	3,0	275	1

Cacerola rectangular con tapa GREY

Faitout rectangulaire avec couvercle
Bratentopf, rechteckig mit Deckel
Rectangular casserole with lid
Çaçarola rectangular com tampa



Ref	€	cm	h (cm)	ml	U.Venta
25845	28,95	13x9	4,5	300	1

Cacerola rectangular con tapa RED

Faitout rectangulaire avec couvercle
Bratentopf, rechteckig mit Deckel
Rectangular casserole with lid
Çaçarola rectangular com tampa



Ref	€	cm	h (cm)	ml	U.Venta
25855	28,95	13x9	4,5	300	1

Cacerola redonda con tapa GREY

Faitout rond avec couvercle
Rund Bratentopf mit Deckel
Round casserole with lid
Çaçarola redonda com tampa



Ref	€	Ø (cm)	h (cm)	ml	U.Venta
25846	24,69	10	5,0	200	1

Cacerola redonda con tapa RED

Faitout rond avec couvercle
Rund Bratentopf mit Deckel
Round casserole with lid
Çaçarola redonda com tampa



Ref	€	Ø (cm)	h (cm)	ml	U.Venta
25856	24,69	10	5,0	200	1

Cacerola oval con tapa GREY

Faitout ovale avec couvercle
Oval Bratentopf mit Deckel
Oval casserole with lid
Çaçarola oval com tampa



Ref	€	cm	h (cm)	ml	U.Venta
25847	29,36	13x10	5,0	400	1

Cacerola oval con tapa RED

Faitout ovale avec couvercle
Oval Bratentopf mit Deckel
Oval casserole with lid
Çaçarola oval com tampa



Ref	€	cm	h (cm)	ml	U.Venta
25857	29,36	13x10	5,0	400	1



Hierro Fundido
Cast Iron



Construida en una sola pieza.
Recubierta con una capa de aceite vegetal.
Ideal para cocinar, prolonga suavemente la cocción.
Gran conductor del calor, mantiene el calor mientras disfrutas y saboreas la comida.
Base de madera para servir y presentar la comida recién cocinada.

Construite en une seule pièce.
Revêtu d'une couche d'huile végétale.
Idéal pour cuisiner, prolonge délicatement la cuisson.
Grand conducteur de chaleur, maintient le plat au chaud pendant que vous dégustez la nourriture.
Base en bois pour servir et présenter le plat fraîchement cuit.

Aus einem Stück gefertigt.
Beschichtet mit einer Schicht von Pflanzenöl.
Ideal zum Kochen, verlängert den Kochvorgang auf sanfte Weise.
Hervorragender Wärmelieferer, erhält die Wärme während Sie die Speisen genießen.
Holzbasis, auf der das soeben zubereitete Gericht serviert und präsentiert wird.

Built in one piece.
Coated with a layer of vegetable oil.
Ideal for cooking, gently continues to cook.
Great heat conductor, retains heat while you enjoy and savour the food.
Wooden base to serve and present freshly cooked food.

Elementos fabricados a partir de uma única peça.
Revestidos com uma camada de óleo vegetal.
Ideal para cozinhar, prolonga suavemente a cocção.
Excelente condutor de calor, mantém o calor enquanto desfrutas da comida.
Base de madeira para servir e apresentar a comida recém-preparada.

Cacerola con base

Faitout avec basse
Bratentopf mit Holzsockel
Casserola with base
Caçarola com base



Ref	€	Ø (cm)	ml	U.Venta
25871	13,38	12,5	230	4
25872	18,26	16,2	470	1
25873	23,45	18,5	720	1

Cacerola

Faitout
Bratentopf
Casserola
Caçarola



Ref	€	Ø (cm)	ml	U.Venta
25771	9,23	12,5	230	4
25772	13,49	16,2	470	4
25773	16,29	18,5	720	1

Cacerola oval con base

Faitout ovale avec basse
Oval Bratentopf mit Holzsockel
Oval casserola with base
Caçarola oval com base



Ref	€	cm	ml	U.Venta
25881	13,49	15x10	200	4
25882	20,85	17,5x12,5	300	1
25883	23,24	21,7x15	700	1

Cacerola oval

Faitout ovale
Oval Bratentopf
Oval casserola
Caçarola oval



Ref	€	cm	ml	U.Venta
25781	10,58	15x10	200	4
25782	16,50	17,5x12,2	300	1
25783	18,78	21,7x15	700	1



Mini Plancha Grill lisa rectangular con base

Mini Plaque Grill lisse rectangulaire sans base
 Mini Platte Grill, glatt mit Holzsocket, rechteckiger
 Mini rectangular Grill plaque flat with base
 Mini Plancha Grill liso rectangular con base

Ref	€	cm	h (cm)	U.Venta
25874	13.07	17x10	2,5	4



Mini Plancha Grill lisa rectangular

Mini Plaque Grill lisse rectangulaire
 Mini Platte Grill, glatt, rechteckiger
 Mini rectangular Grill plaque flat
 Mini Plancha Grill liso rectangular

Ref	€	cm	h (cm)	U.Venta
25774	8.92	17x10	2,5	4



Mini Plancha Grill cuadrado con base

Mini Plaque Grill carré sans base
 Mini Platte Grill mit Holzsocket, Quadrat
 Mini square Grill plaque with base
 Mini Plancha Grill cuadrado con base

Ref	€	cm	h (cm)	U.Venta
25875	13.07	14x14	1,7	4



Mini Plancha Grill cuadrado

Mini Plaque Grill carré
 Mini Platte Grill, Quadrat
 Mini square Grill plaque
 Mini Plancha Grill cuadrado

Ref	€	cm	h (cm)	U.Venta
25775	9.23	14x14	1,7	4



Mini Grill con base

Mini Grill sans basse
 Mini Grill mit Holzsocket
 Mini Grill with base
 Mini Grill com base

Ref	€	cm	h (cm)	U.Venta
25876	15.04	14x14	2,5	1



Mini Grill

Mini Grill
 Mini Grill
 Mini Grill
 Mini Grill

Ref	€	cm	h (cm)	U.Venta
25776	9.65	14x14	2,5	4



Mini sartén lisa con base

Mini poêle lisse avec basse
 Mini Pfanne mit Holzsocket
 Mini frying pan flat with base
 Mini sertã lisa com base

Ref	€	Ø (cm)	h (cm)	U.Venta
25877	14.01	13	1,7	1



Mini sartén lisa

Mini poêle lisse
 Mini Pfanne
 Mini frying pan flat
 Mini sertã lisa

Ref	€	Ø (cm)	h (cm)	U.Venta
25777	9.75	13	1,7	4

► MAGMA MELAMINA



Fabricadas en melamina de alta calidad.
Ofrecen un aspecto muy natural parecido al hierro fundido.
Ideal para servir y presentar los platos más exquisitos.

Fabricată în melamină de înaltă calitate.
Aspect très naturel, semblable à la fonte d'aluminium.
Idéale pour servir et présenter les plats les plus exquis.

Hergestellt aus hochwertigem Melamin.
Sehr natürliches Aussehen, ähnlich wie Gusseisen.
Ideal zum Servieren und Anrichten erlesener Gerichte.

Made of high quality melamine.
Very natural appearance similar to cast iron.
Perfect for serving and presenting the most exquisite dishes.

Fabricado em melamina de alta qualidade.
Aspecto natural similar ao ferro fundido.
Ideal para servir e apresentar os pratos mais exclusivos.

Cacerola redonda

Faitout rond
Rund Bratentopf
Round casserole
Caçarola redonda

Ref	€	Ø (cm)	U.Venta
63384	4,25	16	12
63385	5,29	18	12



Cacerola oval

Faitout ovale
Oval Bratentopf
Oval casserole
Caçarola oval

Ref	€	cm	U.Venta
63388	3,84	18x12	12
63389	4,88	21x15	12



Wok

Wok
Wok
Wok
Wok

Ref	€	Ø (cm)	U.Venta
63386	3,63	15	12
63387	4,98	18	12



Mini Grill

Mini Grill
Mini Grill
Mini Grill
Mini Grill

Ref	€	cm	U.Venta
63382	6,23	13,5x13,5	6



Mini sartén

Mini pôele
Mini Pfanne
Mini frying pan
Mini sertă

Ref	€	Ø (cm)	U.Venta
63381	5,91	15	6



Mini sartén rectangular

Mini pôele rectangular
Mini Pfanne, rechteckiger
Rectangular Mini frying pan
Mini sertă rectangular

Ref	€	cm	U.Venta
63383	4,25	17x11,5	12



▶ MINI CUBOS · CESTILLOS

NO válidos para freír
NOT valid for frying



Una forma elegante y original de servir toda clase de aperitivos y tapas. La presentación puede ser sobre papel absorbente o bien directamente sobre el cestillo.

Uma façon élégante et originale de servir tout type d'apéritifs et amuse gueules. La présentation peut être réalisée sur du papier absorbant ou bien directement sur le panier.

Eine elegante und originelle Art und Weise alle Art von Aperitifs und Tapas zu servieren.
Die Präsentation kann auf saugfähigem Papier oder direkt im Körbchen erfolgen.

An elegant and original way to serve all kinds of snacks and tapas. Can be presented on absorbent paper or directly on the rack.

Uma forma elegante e original de servir todo o tipo de aperitivos e de tapas. A apresentação pode ser sobre papel absorvente, ou diretamente no cesto.



Mini cubo

Mini-cube.
Mini-Eimer.
Mini cube.
Mini cubo.

	Ref	€	Ø (cm)	h (cm)	ml	U.Venta
A	61107	4,15	7	7,0	200	12
B	61109	4,88	9	9,0	340	1
C	61112	6,43	12	12,0	900	1

Cestillo redondo

Panier rond
Korb, Rund
Round basket
Cesta redonda



Ref	€	Ø (cm)	h (cm)	U.Venta
61009	7,47	9	8,0	6



Cestillo redondo BRONCE

Panier rond
Korb, Rund
Round basket
Cesta redonda



Ref	€	Ø (cm)	h (cm)	U.Venta
61069	7,47	9	8,0	6

Cestillo cuadrado

Panier carré
Korb, quadratisch
Square basket
Cesta cuadrada



Ref	€	cm	h (cm)	U.Venta
61007	7,47	10x8	7,0	6
61052	9,65	12x10	9,0	6



Cestillo cuadrado BRONCE

Panier carré
Korb, quadratisch
Square basket
Cesta cuadrada



Ref	€	cm	h (cm)	U.Venta
61067	7,47	10x8	7,0	6
61062	9,65	12x10	9,0	6

Cestilo cónico

Panier conique
Korb, Konisch
Conical basket
Cesta cónica



Ref	€	Ø (cm)	h (cm)	U.Venta
61053	8,20	12	10,0	6



Cestilo cónico BRONCE

Panier conique
Korb, Konisch
Conical basket
Cesta cónica



Ref	€	Ø (cm)	h (cm)	U.Venta
61063	8,20	12	10,0	6

Cestilo rectangular

Panier rectangulaire
Korb, rechteckig
Rectangular basket
Cesta rectangular



Ref	€	cm	h (cm)	U.Venta
61056	11,21	21x11	6,0	1



Cestilo rectangular BRONCE

Panier rectangulaire
Korb, rechteckig
Rectangular basket
Cesta rectangular



Ref	€	cm	h (cm)	U.Venta
61066	11,21	21x11	6,0	1

Cestilo rectangular con asas

Panier rectangulaire avec poignées
Korb, rechteckig mit Griffen
Rectangular basket with handles
Cesta rectangular com alças



Ref	€	cm	h (cm)	U.Venta
61055	11,21	21x11	6,0	1



Cestilo rectangular con asas BRONCE

Panier rectangulaire a/poignées
Korb, rechteckig mit Griffen
Rectangular basket with handles
Cesta rectangular com alças



Ref	€	cm	h (cm)	U.Venta
61065	11,21	21x11	6,0	1

▶ PAELLERA SMALT



Paellera esmaltada SMALT

Plat à paella
Paellapfanne, emailiert
Round dish for paella
Paelheira esmaltada

Ref	€	Ø (cm)	U.Venta
60170	4,36	10	10
60172	4,88	12	10
60175	5,71	15	6
60180	7,37	20	6



Fabricadas en hierro y recubiertas de una capa de esmalte vitrificado, muy resistentes. No se oxidan.
Perfectas para presentar y servir sabrosas tapas, raciones o pinchos.
Aptas para el horno. Aptas para el lavavajillas. Fáciles de limpiar y de almacenar

Fabriquées en fer et recouvertes d'une couche d'émail vitrifié, elles sont très résistantes. Ne rouillent pas.
Parfaites pour présenter et servir de savoureuses tapas, de petites portions ou des amuse-bouches.
Aptes pour le four. Aptes pour le lave-vaisselle. Faciles à nettoyer et à ranger

Aus setiv widerstandsähigem Eisen mit einfacher Glasemailierung. Rostfrei.
Ideal zum Anrichten und Servieren von leckeren Tapas, Gerichten oder Snacks.
Backofengeeignet. Spülmaschinengeeignet. Einfach zu reinigen und zu lagern

Made of iron and coated with a highly durable layer of vitrified enamel. Does not rust.
Perfect for serving or presenting delicious tapas, dishes or appetizers.
Oven safe. Dishwasher safe. Easy to clean and store

Fabricadas em ferro, com capa de revestimento de esmalte vitrificado, muito resistentes. Não se oxidam.
Perfeitas para apresentar e servir sabrosas tapas, rações ou aperitivos.
Aptas para o forno. Aptas para máquinas de lavar louça. Fáceis de limpar e de armazenar

▶ MINI PALET PRESENTACIÓN

New



Abedul
Birch wood

Mini palet para presentación de alimentos.
Fabricado en madera de abedul 100% natural.
Ideal para servir de modo original aperitivos y tapas.
Resistente y duradero.

Mini palette pour la présentation des aliments.
Fabriquée en bois de bouleau 100% naturel.
Idéale pour servir de façon originale des apéritifs et des tapas.
Résistante et durable.

Minipaletta für die Präsentation von Speisen.
Hergestellt aus 100% natürlichem Birkenholz.
Ideal zum Servieren origineller Vorspeisen und Tapas.
Beständig und haltbar.

Mini pallet for presenting food.
Made of 100% natural birch wood.
Perfect for serving appetizers and tapas in an original way.
Strong and long-lasting.

Mini paleta para apresentação de alimentos.
Fabricada em madeira de bétula, 100% natural.
Uma maneira original de servir aperitivos e tapas.
Resistente e durável.

Ideal para servir tapas o aperitivos

Ideal for serving tapas or snacks

A



B



C



D



Mini palet presentación

Mini palette de présentation

Minipaletta für Präsentation

Mini pallet for presentation

Mini paleta de apresentação

	Ref.	€	cm	h (cm)	U. Venta
A	61060	5,71	13x8	3,0	1
B	61059	7,68	20x12	3,0	1
C	61058	10,27	30x20	3,0	1
D	61057	11,83	40x15	3,0	1

▶ TABLAS CRISTAL / PIZARRA & BAMBÚ



Tabla Cristal & Bambú

Planche Verre & Bambou
Glas & Bambusbrett
Glass & Bamboo board
Tábua Vidro & Bambu

Ref	€	Tabla con mango (cm)	Cristal (cm)	U.Venta	
61048	11,00	38,5x21,5x1,5	28x18,5	1	Cuadrada Square
61049	11,52	38,5x27,5x1,5	Ø24,5	1	Redonda Round



Fabricada en bambú natural robusta y muy resistente.
Tabla con mango con una base extraíble ideal para presentar y servir.
Pestaña para facilitar la extracción del cristal/pizarra.
Se aconseja su lavado a mano.

Fabriquée en bambou naturel, robuste et très résistante.
Planche avec manche et dotée d'une base extractible, idéale pour présenter et servir.
Possède une arête pour une meilleure extraction de verre/ardoise.
Il est conseillé de la laver à la main.

Aus natürlichem Bambusholz gefertigt, sehr stabil und strapazierfähig.
Brett mit Griff und entnehmbaren Unterlage, ideal zum Anrichten und Servieren.
Rand hilft beim Entnehmen der Platte.
Am besten von Hand reinigen.

Made of strong and highly durable natural bamboo.
Cutting board with a handle and a removable base perfect for presenting and serving.
Tab for removing the glass/slate.
Washing by hand recommended.

Fabricada em bambu natural, robusta e resistente.
Tábua com mango e base extraível, ideal para apresentar e servir.
Pestaña para facilitar a extração de vidro/ ardósia.
Recomenda-se lavar à mão.

Pizarra y bambú natural 100%

100% natural slate and bamboo



Tabla Pizarra & Bambú

Planche Ardoise & Bambou
Schiefer & Bambusbrett
Slate & Bamboo board
Tábua Ardósia & Bambu

Ref	€	Tabla con mango (cm)	Pizarra (cm)	U.Venta
61045	6,43	40x10x1,5	25x7,5	1



Tabla Pizarra & Bambú

Planche Ardoise & Bambou
Schiefer & Bambusbrett
Slate & Bamboo board
Tábua Ardósia & Bambu

Ref	€	Tabla con mango (cm)	Pizarra (cm)	U.Venta
61046	12,65	50x18x1,5	35x15	4



Tabla redonda Pizarra & Bambú

Planche rond Ardoise & Bambou
Schiefer & Bambusbrett
Round slate & Bamboo board
Tábua redonda Ardósia & Bambu

Ref	€	Tabla con mango (cm)	Pizarra Ø (cm)	U.Venta
61047	17,12	38,5x28x1,5	25	12



Incluye
3 cuencos cerámicos para salsas
Includes 3 ceramic bowls for sauces



Tabla Pizarra & Bambú

Planche Ardoise & Bambou
Schiefer & Bambusbrett
Slate & Bamboo board
Tábua Ardósia & Bambu

Ref	€	Tabla (cm)	Pizarra (cm)	Cuenco (cm)	ml	U.Venta
61042	15,96	28x28x1,5	25x15	8,5x8,5x3	56	1

► LUXE & HIPERLUX

Inox
18/10

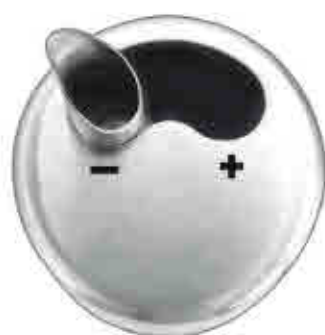

REGULADOR: SISTEMA PATENTADO: Con dispositivo antigoteo para dosificar la cantidad a verter.
RÉGULATEUR: SYSTÈME BREVÉTÉ: Mini d'un dispositif antigouttes et régulateur pour varier la quantité à verser.
REGLER: PATENTIERTES SYSTEM: Mit antitropfvorrichtung und Dosierregler.
REGULATOR: PATENTED SYSTEM: With anti-drip device and regulator for controlling the amount to be poured.
REGULADOR: SISTEMA PATENTEADO: Com dispositivo anti-gota e regulador para dosificar a quantidade a verter.

Juego vinagrera LUXE 4 piezas con soporte

Set vinaigrieres LUXE 4 pièces socle rond
 Essig/Öl-Set, 4-tlg, rund LUXE
 LUXE cruet set 4 pcs
 Jogo galheteiro LUXE 4 peças com suporte

Ref	€	ml	U.Venta
62464	42,75	170-30	1



Juego vinagrera HIPERLUX 4 piezas con soporte

Set vinaigrieres HIPERLUX 4 pièces socle carré
 Essig/Öl-Set, 4-tlg, viereckig HIPERLUX
 HIPERLUX cruet set 4 pc
 Jogo galheteiro HIPERLUX 4 peças com suporte

Ref	€	ml	U.Venta
62465	44,30	200-35	1



Juego aceitera-vinagrera LUXE con soporte

Set huilier et vinaigrier LUXE sur socle rond
 Öl-Essig-Set LUXE
 LUXE oil-vinegar set
 Jogo azeiteira-galheteiro LUXE com suporte

Ref	€	ml	U.Venta
62462	29,98	170	1



Juego aceitera-vinagrera HIPERLUX con soporte

Set huilier et vinaigrier HIPERLUX sur socle rond
 Öl-Essig-Set HIPERLUX
 HIPERLUX oil-vinegar set
 Jogo azeiteira-galheteiro HIPERLUX com suporte

Ref	€	ml	U.Venta
62463	31,33	200	1



Juego salero-Pimentero LUXE con soporte

Set sel/Poivre sur socle rond LUXE sur socle carré
 Salz-/Pfefferstreuer, rund LUXE
 LUXE salt & pepper cruet set
 Jogo saleiro e pimenteiro LUXE com suporte

Ref	€	ml	U.Venta
62466	20,02	30	1



Juego salero-Pimentero HIPERLUX con soporte

Set sel et poivre HIPERLUX sur socle carré
 Salz-/Pfefferstreuer, viereckig HIPERLUX
 HIPERLUX salt & pepper cruet set
 Jogo saleiro e pimenteiro HIPERLUX com suporte

Ref	€	ml	U.Venta
62461	22,31	35	1



Patillero redondo LUXE

Porte cure dents rond, LUXE
 Zahnstocherbüchse, rund, LUXE
 Round toothpick holder, LUXE
 Patillero redondo LUXE

Ref	€	ml	U.Venta
62470	3,63	30	1



BASIC

Inox

Juego vinagrera

Set vinaigrie
Menage
Cruet set
Jogo gaheteiro

Ref	€	ml	U.Venta
62864	11,83	175-37,5	1



Juego aceiteira-vinagrera

Set huilier et vinaigries
Öl-Essig-Set
Oil-vinegar set
Jogo azeteira-gaheteiro

Ref	€	ml	U.Venta
62862	9,44	175	1



Juego Salero-Pimentero

Set salière et poivrière
Salz-Pfeffer-Set
Salt-Pepper set
Jogo Salero-Pimenteiro

Ref	€	ml	U.Venta
62866	4,88	37,5	6



Juego Salero-Pimentero-Mostaza

Set 3 pièces sel poivre moutarde
Salz/Pfeffer/Senf-Set
Salt-Pepper-Mustard set
Salero-Pimenteiro-Mostarda set

Ref	€	ml	U.Venta
62867	7,78	37,5-150	1



CERAMIC

CE

Ceramic

Juego vinagrera 4 piezas

Set vinaigries 4 pièces
Menage 4 Tlg
Cruet set 4 pcs
Jogo gaheteiro 4 peças

Ref	€	ml	U.Venta
62384	33,72	250-100	1



CE

Ceramic

Juego aceiteira-vinagrera

Set huilier et vinaigries
Öl-Essig-Set
Oil-vinegar set
Jogo azeteira-gaheteiro

Ref	€	ml	U.Venta
62382	25,21	250	1



Inox

18/10

Aceitera cónica

Huilier
Ölkanne
Oil-can
Azeteira cónica

Ref	€	L	h (cm)	U.Venta
62525	24,80	0,25	10,0	1
62555	36,42	0,50	19,0	1
62551	44,72	1,00	23,0	1



ALÍÑO



PC

Polycarbon

Pulverizador de aceite

Pulvérisateur d'huile
Öl-Spray
Oil Sprayer
Pulverizador de azeite

Ref	€	Ø (cm)	ml	U.Venta
61908	13,38	7x18	100	1



C

Crystal/Glass

Pulsar · Medir · Verter
Press · Measure · Empty

Dosificador-Medidor de aceite

Doseur distributeur à huile
Öl-Dosierer mit Massanzeige
Oil portionner-measurer
Distribuidor-manómetro de óleo

Ref	€	Ø (cm)	ml	U.Venta
62252	19,51	7,8x23	250	1



PC

Polycarbon

Pulverizador de aceite LUXE

Pulvérisateur d'huile LUXE
Öl-Spray, LUXE
LUXE Oil Sprayer
Pulverizador de azeite LUXE

Ref	€	Ø (cm)	ml	U.Venta
61901	13,07	7x20	200	1



ASA

Acrylic

Botella preparación aliño

Mélangeur
Dressing Mixflasche
Dressing mixer bottle
Garrafa de preparação aliño

Ref	€	Ø (cm)	ml	U.Venta
61918	9,96	6,5x21	300	1



PS

Plastic

Aceitera - Vinagrera DUAL

Huile et vinaigres DUAL
DUAL Öl Essig - Dosiever
DUAL oil-vinager
Azeite-galhetero DUAL

Ref	€	Ø (cm)	ml	U.Venta
61911	14,63	6x20	200	1



PMMA

Plastic

Sist. infusor, agrega sabor al aceite
Infusion system to add flavour to the oil

Aceitera aromatizadora

Huiler diffuseur d'arôme
Aroma-Ölkanne
Flavouring oil dispenser
Dispensador azeite aromatizador

Ref	€	ml	U.Venta
61920	13,49	160	1

Antigoteo
Anti-drip



PC

Polycarbon

Pulverizador de aceite-vinagre

Pulvérisateur d'huile et vinaigres
Öl-Essig Spray
Oil-vinager bottle spray
Pulverizador de azeite-galhetero

Ref	€	Ø (cm)	ml	U.Venta
61921	14,01	5,5x20	200	1



Filtro resistente al calor
Heat-resistant filter

PS

Plastic

Jarra separadora grasas

Séparateur de graisse
Fettabscheider
Gravy/fat separator
Separador de gorduras

Ref	€	ml	Unidades	U.Venta
61610	6,23	500	ml-oz-cup	4



MOLINILLOS



Muele al instante. Muelas: no pierden filo y no se oxidan.
Molido a baja velocidad: conserva mejor las propiedades y aromas.
Funcionamiento sencillo. Muy fácil de limpiar.

Moulin à l'instant. Meules: pas d'usure du fil et pas d'oxydation.
 Mouture à faible vitesse: meilleure conservation des propriétés et des arômes.
 Fonctionnement simple. Très facile à nettoyer.

Mahlt sofort. Mahlwerk: verliert nicht an Schärfe und rostet nicht.
 Langsame Vermahlung: Eigenschaften und Aromen bleiben besser erhalten.
 Einfache Funktionsweise. Sehr einfach zu reinigen.

Grinds instantly. Burs don't get dull or rusty.
 Low speed grind conserves coffee properties and aromas better.
 Easy to use. Very easy to clean.

Mói instantaneamente. Mós, que não perdem o filo e não se oxidam.
 Moagem a baixa velocidade, que conserva melhor as propriedades e os aromas do produto.
 Funcionamento simples. Muito fácil de limpar.

8 niveles de grosor
8 grinding levels

Inox | **Cristal**
18/10 | **Clase**

Muelas cerámicas
 Ceramic burs

Molinillo manual
 Moulin manuel
 Manuelle Mühle
 Manual grinder
 Moimho manual



Ref.	€	g	h (cm)	U.Venta
62817	29,98	45	21	1



Inox

Molinillo DUAL eléctrico Sal - Pimienta

Moulin DUAL électrique à sel - poivre
 Elektrische Salz-/Pfeffermühle, DUAL
 DUAL salt - pepper electric grinder
 Moimho DUAL eléctrico sal - pimenta

Ref.	€	Ø (cm)	h (cm)	U.Venta
62824	18,88	7	18	1

6 pilas de 1,5 V AAA
(NO incluidas)
 6 x 1.5V AAA batteries
 (Not included)

Pulsadores independientes
 Independent switch

Mecanismo cerámico
 Ceramic mechanism

Compartimientos independientes
 Independent compartments



Inox

Molinillo eléctrico

Moulin électrique
 Elektrische Mühle
 Electric grinder
 Moimho eléctrico

Ref.	€	U.Venta
69385	32,27	1



Cuchillas de acero inoxidable
de gran resistencia
 High strength et. steel blades



Ref.	Tensión/Voltage	Potencia/Power	Capacidad/Capacity	Dimensiones/Sizes	Peso/Weight
69385	220-240 V / 50-60 Hz	200 W	60 g (9 cups)	Ø10x18 cm	780 g

HAYA
Wood

Molinillo de pimienta
Moulin à Poivre
Pfeffermühle
Pepper Grinder
Moinho de pimenta em madeira

Ref	€	Ø (cm)	h (cm)	U.Venta
63215	22,83	5,0	15	1
63220	26,77	5,5	20	1
63225	31,75	6,0	25	1

Mecanismo de acero templado
Hardened steel mechanism



ASA
Acrylic

Molinillo doble sal - pimienta
Moulin double à sel - poivre
Salz und Pfeffermüller Doppelt
Salt - pepper double grinder
Moinho duplo de sal - pimenta

Ref	€	Ø (cm)	h (cm)	g	U.Venta
62816	17,64	6	18	90	1

Mecanismo cerámico
Ceramic mechanism



Antideslizante
en la parte superior e inferior
Non-slip upper and lower part

2 en 1
2 in 1



ASA
Acrylic

Molinillo de sal - pimienta
Moulin à sel - poivre
Pfeffer / Salzmühle
Salt - pepper Grinder
Moinho de sal - pimenta

Ref	€	h (cm)	U.Venta
62814	20,44	14	6
62818	21,17	18	6
62823	22,93	23	6

Mecanismo cerámico
Ceramic mechanism



▶ ESPECIEROS INOX

Inox

Capacidad - Capacity: 300 g



Especiero agujeros peq.
Saupoudreuse à figures, fines
Gewürzdose/Streuer, Lochung Klein
Small shaker plastic cover hole lid
Polvilhador burucos pequeno

Ref	€	Ø (cm)	h (cm)	U.Venta
62906	7,37	7	9,50	12



Especiero agujeros grandes
Saupoudreuse à figures, grosses
Gewürzdose/Streuer, Lochung Gross
Large shaker plastic cover hole lid
Polvilhador burucos grandes

Ref	€	Ø (cm)	h (cm)	U.Venta
62905	7,57	7	9,50	12



Especiero agujeros queso
Saupoudreuse à figures, fromage
Gewürzdose/Streuer für Käse
Shaker plastic cover hole lid for cheese
Polvilhador para queijo

Ref	€	Ø (cm)	h (cm)	U.Venta
62904	7,37	7	9,50	12



Especiero malla fina
Saupoudreuse à maille
Gewürzdose/Streuer Fein
Shaker plastic cover fine mesh lid
Polvilhador rede fina

Ref	€	Ø (cm)	h (cm)	U.Venta
62903	7,99	7	9,50	12



Especiero Multiusos
Saupoudreuse multi-usage
Gewürzdose/ Streuer, multifunktional
Multipurpose shaker
Polvilhador multiusos

Ref	€	Ø (cm)	h (cm)	g	U.Venta
62409	8,09	4,2	7,50	80	1

Cerrado
Closed



Pimienta
Pepper



Especias
Spices



Sal
Salt



Pallitos
Technicks



▶ ESPECIEROS

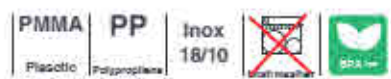

Capacidad - Capacity: 100 g

Pimentero

Poivrière
Pfefferstreuer
Pepper shaker
Pimenteiro



Ref	€	Ø (cm)	h (cm)	U.Venta
61903	9,13	7	12,5	1

Salero

Salière
Salzstreuer
Salt shaker
Salero



Ref	€	Ø (cm)	h (cm)	U.Venta
61907	9,23	7	12,5	1

Especiero queso rayado

Saupoudreuse à fromage
Käsestreuer
Cheese shaker
Polvilhadoqueijo ralado



Ref	€	Ø (cm)	h (cm)	U.Venta
61905	9,15	7	12,5	1

Especiero malla

Saupoudreuse à maille fine
Mehlstreuer
Mesh shaker
Polvilhador rede



Ref	€	Ø (cm)	h (cm)	U.Venta
61906	9,86	7	12,5	1

Azucarro

Saupoudreuse à sucre
Zuckerstreuer
Sugar shaker
Acucareiro



Ref	€	Ø (cm)	h (cm)	U.Venta
61904	10,48	7	12,5	1

Dispensador miel

Distributeur de miel
Honigbehälter
Honey dispenser
Dositicador mel



Ref	€	Ø (cm)	h (cm)	U.Venta
61909	12,14	7	12,5	1

Molinillo

Moulin
Salz-Pfefferstreuer
Grinder
Moinho



Ref	€	Ø (cm)	h (cm)	U.Venta
61913	11,72	7	12,5	1



Vaso

Timbale
Trinkbecher
Tumbler
Copo

Ref.	€	Ø (cm)	L.	U.Venta
62406	5,08	7,5x10	0,30	20



Sopera con base

Soupiere sur pied
Suppenschüssel mit Fussreif
Soup-tureen with base
Sopeira com base

Ref.	€	Ø (cm)	L.	U.Venta
60823	27,91	22	2,00	1
60825	29,88	24	2,50	1
60829	36,83	28	4,00	1



Tapa sopera

Couvercle soupiere
Deckel für Servierschüssel
Soup-tureen lid
Tampa sopeira

Ref.	€	Ø (cm)	U.Venta
60922	17,74	22	1
60924	19,61	24	1
60928	23,03	28	1



Legumbrera

Legumiere
Servierschüssel
Vegetable dish
Legumeira

Ref.	€	Ø (cm)	L.	U.Venta
60812	21,68	22	2,0	1
60814	24,38	24	3,0	1
60818	32,06	28	4,5	1

Inox

6 bols pequeños

6 petit bols
6 Schüsseln, klein
Vegetable bowls set of 6
6 bacias pequenas mesa Service

Ref.	€	Ø (cm)	ml	U.Venta
14012	9,75	12	325	1



Ensaladera redonda

Saladier ronde
Salatschüssel, rund
Round salad bowl
Bacia de salada redonda

Ref.	€	Ø (cm)	L.	U.Venta
62394	10,58	25	4,0	1



Quesera parmesana con cuchara

Boite à fromage à cuillère
Parmesanmenage mit Löffel
Parmesan bowl with spoon
Queijeira parmesana com colher

Ref.	€	Ø (cm)	ml	U.Venta
62970	26,98	9x5	200	1
Recipiente cristal				
62971	3,53			18



Salsera LUXE con cuchara

Sauciere "Luxe"
Sauciere Luxe
Gravy boat "Luxe"
Molheira "LUXE" com colher

Ref.	€	ml	U.Venta
62424	20,34	200	1



Salsera ALADINO

Sauciere "Aladino"
Sauciere "Aladino"
Gravy boat "Aladino"
Molheira "Aladino"

Ref.	€	cm	ml	U.Venta
61409	8,30	13x6x8	90	1
61415	9,96	15,5x7,2x10	150	1
61424	13,49	19x8,5x12,5	240	1
61430	14,42	20x9,5x12,5	300	1



Fuente de mantequilla

Beurier avec couvercle
Butterdose mit Deckel
Butter dish with cover
Manteigueira



Ref	€	cm	h (cm)	U.Venta
62951	12,24	11,5x22,5	6,5	1



Azucarero sobremesa

Sucrier de table sphérique
Zuckerdose, Kugelförmig
Spherical table sugar bowl
Açucareiro de mesa esférico



Ref	€	Ø (cm)	ml	U.Venta
63304	14,01	14	600	1

Cubre platos

Cloches
Tellerabdeckung
Plate cover
Cloche para pratos



Ref	€	Ø (cm)	h (cm)	U.Venta
69024	22,00	24	11,0	1
69029	33,10	28	17,5	1



Cubre quesos / Tartas

Couvre Fromage/Gâteau
Tellerabdeckung
Cheese/Cake cover
Cloque para Queijo/Tartas



Ref	€	Ø (cm)	U.Venta
62380	45,24	32	1

Inox



Indicador Reservado

Indicateur Réserve
Reserviert-Aufsteller
Reserved signal
Indicador reservado

Ref	€	cm	U.Venta
61098	3,74	5x12	6

Inox

Números de mesa

Números de table
Tischnummernschild
Table numbers
Números para tabela



Ref	€	cm	Números	U.Venta
61095	17,22	6x5	1-12	1
61096	17,22	6x5	13-24	1
61097	17,12	6x5	25-36	1

Soporte menu con pinza

Support menu à pince
Menükartenhalter
Menu card holder
Suporte menú com pinça



Ref	€	h (cm)	U.Venta
61008	11,10	20,0	1
61012	12,45	30,0	1

Inox

Pinza sujeta manteles (4 Pcs.)

Pince à nappe
Tischluchtklammer
Tablecloth pegs
Pinça para toalhas de mesa



Ref	€	U.Venta
61023	5,91	6

Inox

Campanilla de recepción

Sonnette de réception
Rezeptionsklingel
Reception call bell
Campanha de recepção



Ref	€	Ø (cm)	U.Venta
61025	9,75	10	1

Inox
18/10

Papelera sobremesa

Poubelle de table
Tish-Abfallbehälter
Table bin
Papeleira de mesa



Ref	€	Ø (cm)	L	U.Venta
63302	20,75	12x16	1,20	1

Inox

Servilletero Bar

Distributeur de serviettes bar
Serviettenspender
Bar napkin holder
Guardanapo bar



Ref	€	cm	Servilleta	U.Venta
61001	11,21	8,5x12	90x125	1

Servilletero

Distributeur de serviettes
Serviettenspender
Napkin holder
Guardanapo



Ref	€	cm	h (cm)	U.Venta
61004	11,62	18x19	5,0	1

Inox

Servilletero Bar

Distributeur de serviettes bar
Serviettenspender bar
Bar napkin holder
Guardanapo bar



Ref	€	cm	Servilleta	U.Venta
61002	8,09	9,5x13,5	90x125	4

Inox

Cepillo recoge-migas

Ramasse-miettes à rouleaux
Krümelbürste
Crumbs cleaner
Escova apanha-migalhas



Ref	€	cm	h (cm)	U.Venta
64407	12,66	9,5x16,5	4,0	1



Cepillo recogedor HIPERLUXE

Ramasse-miettes à rouleaux HIPERLUXE
Krümelbürste, HIPERLUXE
HIPERLUXE crumbs cleaner
Escova apanha-migalhas HIPERLUXE



Ref	€	cm	U.Venta
64408	42,75	14,5x17	1

PP

ABS

Stackable

Bandeja cambios COIN

Coupelle ramasse monnaie
Wechselgeldablagen
Change tray
Bandeja para trocos



Ref	€	Ø (cm)	U.Venta
68720	2,70	13	12



Cepillo recogedor LUXE

Ramasse-miettes LUXE
Krümelbürste, LUXE
LUXE crumbs cleaner
Espátula apanha-migalhas LUXE



Ref	€	cm	U.Venta
64409	27,08	22x7	1

Bandeja con pinza para notas

Porte addition à pinces
Platte mit Klemmvorrichtung
Bill holder
Bandeja com pinça para notas



Ref	€	cm	U.Venta
68007	4,57	11x15,2	12

A	68007	4,57	11x15,2	12
B	68017	5,40	12x21,5	12



Cenicero cuadrado

Cendrier carré
Aschenbecher, viereckig
Ashtray square
Cinzeiro quadrado.

Ref	€	Ø (cm)	U.Venta
62941	5,50	14	1



Cenicero redondo

Cendrier rond
Aschenbecher, rund
Ashtray round
Cinzeiro redondo.

Ref	€	Ø (cm)	U.Venta
62913	6,23	13	1
62916	8,40	16	1



Cenicero redondo

Cendrier rond
Aschenbecher, rund
Ashtray round
Cinzeiro redondo.

Ref	€	Ø (cm)	U.Venta
14013	2,39	14	12
14065	2,70	16	12

▶ ENCENDEDOR DE GAS



Encendedor de gas

Allume-gaz à flamme
Gasanzünder
Gas lighter
Isqueiro de gás



Ref	€	L (cm)	U.Venta
68987	3,42	27	6

Encendido con gatillo.
Recargable.
Sistema de bloque de seguridad.
Regulador de llama.

Allumage avec gâchette
Rechargeable.
Système de sécurité par blocage
Régulateur de flamme

Entzündet auf Knopfdruck.
Wieder aufladbar
Sicherheitssperre.
Flammenregler

Trigger lighter
Rechargeable.
Safety lock system
Flame regulator

Com gatillo para acender
Recargável.
Sistema de bloqueio de segurança.
Regulador de chama.



Encendedor de gas caña fija

Allume-gaz à flamme tige fixe
Gasanzünder, Stab fixe
Gas lighter fixe rod
Isqueiro de gás fixa

Ref	€	L (cm)	U.Venta
A 68975	30,81	-	1
B 68978	3,01	27	12



Encendedor de gas caña flexible

Allume-gaz à flamme tige flexible
Gasanzünder, Stab biegebar
Gas lighter flexible rod
Isqueiro de gás flexível

Ref	€	L (cm)	U.Venta
A 68977	39,43	-	1
B 68979	3,63	27	12

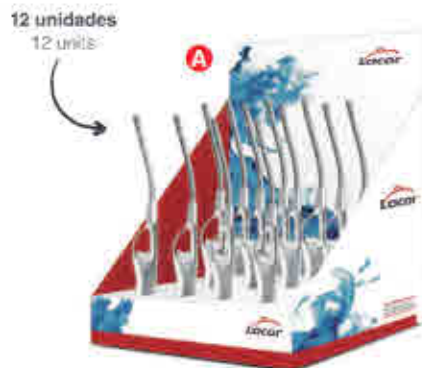



Pinzas
Tongs

#CocinaConLacor

PINZAS

Inox
18/10

Inox

Pinza servicio mesa

Pince à servir
Servierzange
Serving tong
Pinça de serviço de mesa



Ref	€	L (cm)	U.Venta
62307	4,15	21	12

Tenedor - Cuchara servir

Pince à service
Servierzange
Utility long
Garfo e colher de servir



Ref	€	L (cm)	U.Venta
68009	8,51	24	6



Cuchara pinza servir

Cuillère pince à service
Servieröffel, Zange
Serving spoon long
Concha pinça de servir



Ref	€	L (cm)	U.Venta
62353	10,48	24	1

Pinza hamburguesa

Pince inox pour hamburger
Zange für Burgers
Tongs for beef Burgers
Pinça de hamburger



Ref	€	L (cm)	U.Venta
62318	10,27	24	12

Pinza pasta LUXE

Pince à spaghetti Luxe
Teigwaren Zange Luxe
Pasta Tong Luxe
Pinça massas Luxe



Ref	€	L (cm)	U.Venta
62981	8,72	20	1

Pinza pasta

Pince à spaghetti
Teigwaren Zange
Spaguetti Tong
Pinça massas



Ref	€	L (cm)	U.Venta
62986	4,67	19	12

Pinza pan

Pince à pain
Brotzange
Bread tong
Pinça pão



Ref	€	L (cm)	U.Venta
62978	7,57	18	1

Pinza pan

Pince à pain
Brotzange
Bread tong
Pinça pão



Ref	€	L (cm)	U.Venta
62982	14,53	23	12

ASA



Acrylic

Pinza ensalada

Pince à salade
Salatzange
Salad tong
Pinça de salada



Ref	€	L (cm)	U.Venta
68021	4,15	28,5	12

ASA



Acrylic

Pinza ensalada

Pinces à salade
Salatzange
Salad scissor tong
Pinça de salada



Ref	€	L (cm)	U.Venta
62374	7,99	29	1



Tenedor + Cuchara ensalada
Fourchette + Cuillère à salade
Gabel + Löffel Acryl
Salad spoon + fork
Garfo + colher de salada



Ref	€	L (cm)	U.Venta
62399	6,54	30	1

Inox

Pinza azucarillos
Pince à sucre
Zucker Zange
Food tong
Pinça picubos de açúcar



Ref	€	L (cm)	U.Venta
62985	3,11	11	6

Pinza reposteria
Pince à gâteau
Gebäck-Tortenzange
Cake tong
Pinça pastelaria



Ref	€	L (cm)	U.Venta
62317	10,06	20	1

Pinza reposteria con anillas
Pince à gâteau avec anneaux
Gebäckzange
Cake tong with rings
Pinça pastelaria com anilhas



Ref	€	L (cm)	U.Venta
68008	5,08	16	6

Pinza para bolsitas de té
Pince pour sachets de thé
Teebeutelzange
Tea bag tong
Pinças para saquetas de chá

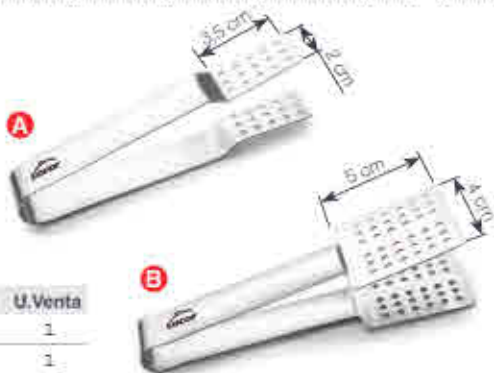

Ref	€	L (cm)	U.Venta
A 68078	1,97	13,5	1
B 68079	3,11	14,0	1



New

Exprime fácilmente tu infusión sin riesgo de mancharte o quemarte.
Diseñada para una extracción fácil y efectiva de la bolsa de té.
Orificios para exprimir hasta la última gota.
Mango de acero inoxidable para un agarre cómodo y seguro.

Squeeze easily your infusion without the risk of leaving or burning yourself!
Designed for easy and effective tea bag removal.
Holes for squeezing out the last drop.
Stainless steel handle for a comfortable and safe grip.

Pinza hielo
Pince à glace
Eiszange
Ice tong
Pinça de gelo



Ref	€	L (cm)	U.Venta
62306	3,94	18,5	12

Inox

Pinza hielo LUXE
Pince à glace Luxe
Eiszange, Luxe
Luxe ice tong
Pinça de gelo Luxe



Ref	€	L (cm)	U.Venta
62337	8,51	20	12

Pinza de Hielo
Pince à glace
Eiszange
Ice tong
Pinça de gelo



Ref	€	L (cm)	U.Venta
62977	7,06	14	6

Pinza multiusos LUXE
Pince multi-usages
Allzweck Zange
Multipurpose tong
Pinça multiusos Luxe



Ref	€	L (cm)	U.Venta
62334	17,02	25	1

Inox

Pinza multiusos
Pince multi-usages
Allzweck-Zange
Luxe long
Pinça multiusos



Ref	€	L (cm)	U.Venta
62984	3,22	16	5

Pinza LUXE
Pince Luxe
Zange Luxe
Luxe long
Pinça Luxe



Ref	€	L (cm)	U.Venta
62983	13,18	30	12

Pinza Jumbo
Pince de service
Jumbo Zange
Utility tong
Pinça Jumbo



Ref	€	L (cm)	U.Venta
62924	4,88	24	12
62930	5,71	30	12
62940	6,74	40	12

Pinza Jumbo Nylon
Pince de service
Jumbo Zange
Utility tong
Pinça Jumbo



Ref	€	L (cm)	U.Venta
62926	6,43	24	12
62929	7,37	30	12
62939	9,55	40	12

Pinza Grill
Pince à grill
Grillzange
Grill tong
Pinça grelhador



Ref	€	L (cm)	U.Venta
62933	12,87	30	6



Pinza large silicone
Pince long en silicone
Zange aus Silikon
Long Silicone tong
Pinça comprida silicone



Ref	€	L (cm)	U.Venta
62931	7,78	29	1

Mango revestido, en distintos colores, con una capa de ABS aislante térmica para una mejor sujeción.

Manche enrobé, en différents couleurs, d'une couche d'ABS isolante thermique et une meilleure prise en main.

Griff in verschiedenen Farben mit einer isolierenden und antirutsch ABS-Schicht überzogen.

Handle coated, in different colours, with a layer of ABS thermal insulation and an enhanced grip.

Mango revestido com uma capa de ABS isolante térmico, de diferentes cores, para uma melhor sujeição.

ASA



Pinzas KARU

Pinces
Zanges
Tongs
Pinças



Ref	€	L (cm)	Color	U.Venta	Ref	€	L (cm)
A 63060	6,33	24	Rojo / Red	12	63070	6,74	30
B 63061	6,33	24	Negro / Black	12	63071	6,74	30
C 63062	6,33	24	Azul / Blue	12	63072	6,74	30
D 63063	6,33	24	Amarillo / Yellow	12	63073	6,74	30
E 63064	6,33	24	Verde / Green	12	63074	6,74	30
F 63065	6,33	24	Marrón / Brown	12	63075	6,74	30

Inox SI 200°C
Silicone max



Pinzas silicona (25 pcs.)

Pinces silicon
Silikon Zangen
Silicone tongs
Pinças silicone

	Ref	€	L (cm)	Color	U.Venta
A	64434	58,10	18,0	Caja (25 pcs.) / Set (25 pcs.)	1
B	64432	2,49	18,0	Naranja / Orange	12
C	64433	2,49	18,0	Rojo / Red	12
D	64436	2,49	18,0	Azul / Blue	12
E	64437	2,49	18,0	Verde / Green	12
F	64439	2,49	18,0	Morada / Purple	12



Pinza de precisión

Pince de précision
Präzision zange
Precision tong
Pinça de precisão

	Ref	€	L (cm)	U.Venta
A	62954	4,57	16	1
B	62821	5,40	21	1

Pinza de precisión recta

Pince de précision droite
Präzisionszange glatt
Straight precision tong
Pinça de precisão reta

	Ref	€	L (cm)	U.Venta
	62955	4,57	15,5	1
	62956	8,92	21,0	1



Cuchara para miel

Cuillère à miel
Honigöffel aus Edelstahl
St steel honey spoon
Colher para mel

	Ref	€	L (cm)	U.Venta
	61361	9,03	16,5	1



Zamak
Zinc
Alloy

Tenaza extractor huesos aceitunas

Dénoyauteur, Chromé
Olivenentsteiner, Verchromt
Zinc alloy olive seed remover
Tenaz extrator de ossos de azeitonas

	Ref	€	L (cm)	U.Venta
	62973	6,85	15	1



Pinza para horno y bandeja GN

Pince inox pour bac Gastronorm
Zange für GN Behälter
Tong GN tray
Pinça para forno e bandejas GN

	Ref	€	L (cm)	U.Venta
	62989	14,63	20	12



SI 200°C
Silicone max

Pinza con silicona para horno y bandeja

Pince inox pour bac Gastronorm avec Silicone
Zange für GN Behälter, mit Silikon
Oven tray tong with Silicone
Pinça para forno e bandejas com silicone

	Ref	€	L (cm)	U.Venta
	62998	14,63	20	12



Inox
18/10

Inox

Tenaza marisco

Pince à casse-homard
Hummerzange
Lobster cracker
Tenaz mariscos



Ref	€	L (cm)	U.Venta
62908	11,10	16	12

Inox

Tijera - Tenaza marisco

Pince Casse Homard
Schere/Zänge Meerestfrüchte
Sea food Scissor Tong
Tesoura - Tenaz marisco



Ref	€	L (cm)	U.Venta
62974	14,75	18,5	12

Inox

6 pinchos para marisco

Ensemble 6 curettes à homard
Hummergabel (6)
6 Pcs. seafood forks
6 espetos para marisco



Ref	€	L (cm)	U.Venta
62976	25,73	18,5	1

Abre ostras LUXE

Couteau à huîtres LUXE
Austermesser, LUXE
LUXE oyster opener
Aberto-ostras LUXE



Ref	€	L (cm)	U.Venta
62684	10,79	20	1

Desescamador de pescado

Grattoir de poissons
Fischschuppenentferner
Fish scraper
Raspador de peixe



Ref	€	L (cm)	U.Venta
39041	10,17	27,5	1

Pinza quita-espigas

Pince à arêtes
Grätenzange
Fish-bone tweezers
Pinça tira-espigas



Ref	€	L (cm)	U.Venta
62938	4,05	8	1
62928	5,08	12	1

Inox

Desescamador de pescado

Grattoir de poissons
Fischschuppenentferner
Fish scraper
Raspador de peixe



Ref	€	L (cm)	U.Venta
39040	7,05	19	1

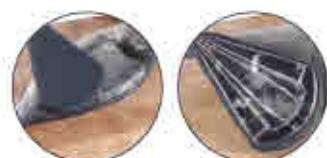

New
Las escamas se quedan atrapadas en la funda.
The scales get trapped in the cover.

Funda de silicona
Silicone cover

Doble hojas dentadas
Double toothed slats

Sistema Patentado



Desescamador de pescado

Grattoir de poissons
Fischschuppenentferner
Fish scraper
Raspador de peixe

Ref	€	Cabezal (cm)	L (cm)	U.Venta
39042	20,65	9x13,5	30	1

A R39042A	6,74	9x13,5	14	1	Funda silicona Silicone cover
------------------	------	--------	----	---	----------------------------------

Zamak
Zinc Alloy

Casca nueces

Casse noix
Nussknacker
Nut cracker
Parte-nozes



Ref	€	U.Venta
63016	13,28	6

Zamak
Zinc Alloy

Casca nueces

Casse Noix
Nussknacker
Nut Cracker
Parte-nozes



Ref	€	U.Venta
63017	16,60	6

3 in 1

Cafetería
Coffee
#CocinaConLacor



► MOLINILLOS DE CAFÉ



69485

Disfruta de todo el aroma y sabor de un café recién molido.
 Embudo de 200g de capacidad con tapa.
 Fresa cónica de acero inoxidable, muele el café uniformemente,
 19 diferentes niveles de molido, se adapta a todo tipo de cafeteras y a la
 intensidad de sabor que se desee.
 Selector de tazas de 1 a 12 tazas, mantiene los granos frescos y evita el
 desperdicio del café.
 Contenedor transparente extraíble de 100 g. Libre de BPA.

Profitez de tout l'arôme et du goût du café fraîchement moulu.
 Entonnoir d'une capacité de 200 g avec couvercle.
 Une fraise conique en acier inoxydable, qui moule le café de manière régulière
 19 niveaux de mouture différents, elle s'adapte à tous les types de machines à
 café et à l'intensité de goût souhaitée.
 Sélecteur de tasses de 1 à 12 tasses, il permet de conserver la fraîcheur des
 grains et d'éviter le gaspillage de café.
 Récipient transparent amovible de 100 g. Sans BPA.

Enjoy the taste and aroma of freshly ground coffee.
 Hopper with a capacity of 200 g with a lid.
 Conical stainless steel cutter to ensure the coffee is ground uniformly
 19 different grind sizes to choose from, suitable for all types of coffee machines
 and for all flavour intensities.
 Choose between 1 and 12 cups to keep the coffee grounds fresh and avoid
 wasting coffee.
 Removable 100 g transparent container. BPA-free.

19 diferentes niveles de molienda - 19 different grind sizes



Número de tazas Number of cups	Tiempo de molido Grinding time
2	8 seg
4	12 seg
6	20 seg
8	24 seg
10	28 seg
12	30 seg

Ideal para moler café y otros productos como semillas, hierbas, frutos secos, cereales, sal, pimienta, azúcar o especias.

Perfect for grinding coffee or other products like seeds, herbs, nuts, grains, salt, pepper, sugar or spices.



Cuchillas de acero inoxidable de gran resistencia
 High strength st. steel blades

Molinillo Inox
 Moulin en inox
 Mühle aus Edelstahl
 St steel grinder
 Moimho Inox

Ref	€	W	g	U.Venta
69385	32.27	200	60	1

New

Selector de tazas,
 de 1 a 12 tazas
 Cup selector, 1 to 12 cups

Molinillo de café KALDI
 Moulin à café
 Kaffeemühle
 Coffe grinder
 Moedor de café

Ref	€	W	g	U.Venta
69485	101.26	200	200 / 100	1

Ref	Tensión/Voltage	Potencia/Power	Capacidad/Capacity	Niveles dispensado Levels dispensed	Niveles de molidos Grinding levels	Dimensiones/Sizes	Peso/Weight
69385	220-240 V : 50/60 Hz	200 W	60 g (9 cups)	-	-	Ø10x18 cm	0,780 Kg
69485	220-240 V : 50/60 Hz	200 W	200 g (Granos · grains) 100 g (molido · ground)	12	19	15,2x21x26 cm	1,85 Kg

Capacidad: 45 g
Capacity: 45 g

Muelas cerámicas
Ceramic burr



Muele al instante y conserva mejor las propiedades y aromas.
Ideal para moler café y otros productos como semillas, hierbas, frutos secos, cereales, sal, pimienta, azúcar o especias.

Moud à l'instant et conserve mieux les propriétés et les arômes.
Idéal pour moulin le café et d'autres produits tels que les graines, les herbes, les fruits secs, les céréales, le sel, le poivre ou les épices.

Mahl sofort und bewahrt die Eigenschaften und Aromen besser.
Perfekt zum Mahlen von Kaffee oder anderen Produkten wie Körn, Kräuter, Trockenobst, Getreide, Salz, Pfeffer oder Gewürze.

Grinds instantly and better preserves the properties and aromas.
Perfect for grinding coffee or other products like seeds, herbs, nuts, grains, salt, pepper, sugar or spices.

Mói instantaneamente e preserva melhor as propriedades e os aromas.
Ideal para moer café e outros produtos, como sementes, ervas, frutos secos, cereais, sal, pimenta, açúcar e especiarias.



8 niveles de grosor
8 grinding levels

Inox 18/10
Cristal
Glass

Molinillo manual
Moulin manuel
Manuelle Mühle
Manual grinder
Moinho manual

Ref	€	g	h (cm)	U.Venta
62817	29,98	45	21	1

Niveles de grosor - Grinding levels



LECHERAS



Inox

Lechera
Pot crémier
Milchkanne
Milk jug
Leiteira

Ref	€	Color	L	e (mm)	U.Venta
A 58151	11,52	GREY	0,35	1	1
A 58152	13,70	GREY	0,60	1	1
B 58251	11,52	RED	0,35	1	1
B 58252	13,70	RED	0,60	1	1



Ideales para bares, cafeterías, hoteles, restaurantes, hogares, etc.
Fabricadas en acero inoxidable de máxima calidad, resistente y duradera.
Pueden utilizarse tanto para líquidos calientes como fríos.
Perfectas para espumar, calentar y servir la leche con el té o café.
Boquilla vertedora para evitar goteos y un mango resistente al calor.
Diseñadas para soportar altas temperaturas. Aptas para el lavavajillas.

Idéal pour les bars, les cafés, les hôtels, les restaurants, pour un usage domestique, etc.
Fabriqués en acier inoxydable de la plus grande qualité, résistant et durable.
Peut être utilisé aussi bien pour des liquides chauds que froids.
Parfait pour mousser ou réchauffer et servir le lait avec le thé ou le café.
Boc verseur anti-goutte et manche résistant à la chaleur.
Conçu pour supporter de hautes températures. Aptes pour le lave-vaisselle.

Ideal for bars, cafés, hotels, restaurants, homes, etc.
Manufactured in high quality, strong and durable stainless steel.
Can be used for both hot and cold liquids.
Perfect for frothing or heating and serving milk with tea or coffee.
Pouring spout to prevent dripping and heat-resistant handle.
Designed to withstand high temperatures. Dishwasher safe.



Inox 18/10

Lechera Barista
Pot crémier pour baristas
Milchkanne für Baristas
Barista milk jug
Leiteira barista

Ref	€	Color	L	e (mm)	U.Venta
A 58050	24,49	INOX	0,50	1	1
B 58150	26,98	GREY	0,50	1	1
C 58250	26,98	RED	0,50	1	1

▶ ESPUMADORES DE LECHE



Disfruta de una espuma fina y cremosa en pocos segundos.
 Capacidad espuma: 115 ml / Capac. calentamiento: 240 ml (69396) - 250 ml (69398).
 Tecnología magnética, el movimiento de los accesorios se crea por atracción(69398).
 Apagado automático.
 Base independiente rotativa de 360°, fácil de rellenar y verter.
 Funcionamiento silencioso.
 Indicador de luz que visualiza si la leche está caliente o fría.
 Apta para leches vegetales. Fácil de limpiar.

Obtenez une mousse fine et crémeuse en secondes seulement.
 Capacité de mousse : 115 ml / Capacité de chauffe : 240 ml (69396) - 250 ml (69398).
 Technologie magnétique, le mouvement des accessoires a lieu par attraction (69398).
 Arrêt automatique.
 Base indépendante rotative de 360°, sans fil, facile à remplir et à verser.
 Fonctionnement silencieux.
 Indicateur lumineux qui indique si le lait est chaud ou froid.
 Apte pour les laits végétaux. Facile à nettoyer.

Samiger Schaum in nur Sekunden genussbereit.
 Milchschaum: 115 ml / warme Milch: 240 ml (69396) - 250 ml (69398).
 Magnettechnik, Zubehör bewegen sich durch Anziehungskraft (69398).
 Abschaltautomatik.
 Die Basis ist um 360° drehbar, ohne Kabel, einfaches Ein- und Ausgießen.
 Geräuscharmer Lauf.
 Kontrollleuchte zeigt an, ob die Milch warm oder kalt ist.
 Pflanzenmilchgeeignet. Leichte Reinigung.

Enjoy a fine, creamy foam in as little seconds.
 Frothing capacity: 115 ml / Heating capacity: 240 ml (69396) - 250 ml (69398).
 Magnetic technology. The movement of the accessories is created with attraction (69398).
 Automatic shut-off.
 360° rotating independent base, easy to fill and pour.
 Silent operation.
 The indicator light shows whether the milk is hot or cold.
 Suitable for plant milk and easy to clean.

Desfruta de uma espuma fina e cremosa em apenas unos segundos.
 Capacid. de espuma: 115 ml / Capacid. de aquecimento: 240 ml (69396) - 250 ml (69398).
 Tecnologia magnética: o movimento dos acessórios gera-se pela atração (69398).
 Desconexão automática.
 Base independente rotativa de 360°, sem cabos, fácil de encher e de verter.
 Funcionamento silencioso.
 Indicador luminoso, que indica se o leite está quente ou frio.
 Apto para leites de origem vegetal. Fácil de limpar.



Calentar
Heat

3 in 1



Calentar y espumar. Espumar leche fría
Heat and froth. Froth cold milk.



Espumador de leche
 Mousseur à lait
 Milchaufschäumer
 Milk frother
 Espumador de leite



New

Jarra de cristal
Glass jug



Espumador de leche MAGNETIC
 Mousseur à lait
 Milchaufschäumer
 Milk frother
 Espumador de leite

Ref	€	W	ml	U.Venta
69396	53,12	500	240	1

Ref	€	W	ml	U.Venta
69398	66,09	600	250	1

Ref	Tensión/Voltage	Potencia/Power	Cap. espuma/Cap. foam	Cap. leche/Cap. milk	Base/Base	Dimensiones/Sizes	Peso/Weight
69396	220-240 V; 50/60 Hz	500 W	115 ml	240 ml	360°	Ø10x21 cm	650 g
69398	220-240 V; 50/60 Hz	600 W	115 ml	250 ml	360°	11,8x11,8x19,5 cm	900 g

CAFETERA ESPRESSO SENCE

New

Calorita
Home



Un café
A coffee

Dos cafés
Two coffees

Calentar y espumar
Heat and froth milk

Inox



Cafetera espresso ideal para preparar todo tipo de cafés, espresso, capuccino, latte machiato, etc. Consegurás un café perfecto y rápido gracias a sus 15 bares de presión. Fácil de usar, muy intuitiva. Indicadores luminosos en cada función. Función manual y automática. Permite programar el ciclo de vertido a tu gusto. Incluye vaporizador con protección para espumar leche y preparar cappuccinos. Brazo portafiltros con doble salida, te permite preparar uno o dos cafés a la vez. Bandeja superior calienta tazas de acero inoxidable, calienta la taza previamente para evitar el contraste térmico. Bandeja de goteo desmontable con indicador de nivel para facilitar la limpieza. Sistema de ahorro energético con apagado automático. Apta para usar con café molido y con cápsulas ESE.

Cafetière espresso idéale pour préparer tout type de café, espresso, cappuccino, latte machiato, etc. Conière un café parfait et rapide grâce à ses 15 bars de pression. Facile à utiliser, très intuitive. Indicateurs lumineux pour chaque fonction. Fonction manuelle et automatique. Permet de programmer le cycle d'écoulement selon convenance. Inclut un vaporisateur avec protection pour mousser le lait, chauffer l'eau pour les infusions et préparer des cappuccinos. Bras porte-filtres avec double sortie, qui permet de préparer un ou deux cafés à la fois. Plateau réchauffe-tasses en acier inoxydable, qui réchauffe les tasses au préalable pour éviter le choc thermique. Plateau d'égouttage démontable avec indicateur de niveau pour faciliter le nettoyage. Système d'économie d'énergie avec arrêt automatique. Convient pour une utilisation avec du café moulu et des capsules ESE.

Espresso coffee machine, perfect for making all types of coffee, including espresso, cappuccino, latte, macchiato, etc. You'll have a perfect coffee in no time at all thanks to its 15 pressure bars. It's easy to use and very intuitive. Each function is accompanied by light indicators. Manual and automatic settings. You can personalise the pouring time. Includes a steam wand with a protector for frothing milk, dispensing hot water for teas and preparing cappuccinos. The two-spout filter holder allows you to make one or two coffees at the same time. Stainless steel cup-warming tray heats up the cups before using them to keep the coffee warmer for longer. Detachable drip tray with water level indicator to aid cleaning. Energy-saving system with automatic shut-off. Suitable for use with ground coffee and ESE capsules.

Apta para usar con cápsulas ESE
Suitable for use with ESE capsules



Cafetera Espresso SENCE

Cafetière Espresso
Espresso-Maschine
Espresso coffee maker
Cafeteira Espresso

Ref	€	W	L	U.Venta
69256	155,52	850	1,50	1



Ref	Tensión/Voltage	Potencia/Power	Presión/Pressure	Capacidad/Capacity	Dimensiones/Sizes	Peso/Weight
69256	220-240 V ; 50/60 Hz	850 W	15 bar	1,50 L	21x26,5x30 cm	3,60 Kg

CAFETERAS INOX



Fabricadas en acero inoxidable 18/10 de gran calidad y resistencia.
Diseño elegante.
Asa formada por un solo tubo de acero aislante del calor.
Válvula de seguridad oculta dentro del sistema de cierre.
Alta conductividad térmica. Café aromático y sabroso en cuestión de minutos.
Aptas para todo tipo de fuegos, incluida la inducción.
Apta para el lavavajillas.

Fabricadas en acier inoxydable 18/10 d'une grande qualité et résistance.
Conception élégante.
Anse composée d'un seul tube en acier isolant de la chaleur.
Soupape de sécurité cachée dans le système de fermeture.
Haute conductivité thermique. Café aromatique et savoureux en quelques minutes.
Compatibles avec tous types de feux, y compris l'induction.
Apte pour le lave-vaisselle.

Aus widerstandsfähigem und hochwertigem Edelstahl 18/10.
Edles Design.
Griff aus wärmeisolierendem Stahlrohr.
Sicherheitsventil im Verschluss versteckt.
Hohe Wärmeleitfähigkeit. Minutenschneller aromatischer Kaffeegenuss.
Für alle Herdarten inklusive Induktion geeignet. Spülmaschinengeeignet.

Made from high quality, durable 18/10 stainless steel.
Stylish design.
Handle formed from a single heat-resistant steel tube.
Safety valve hidden within the closure system.
High thermal conductivity. Aromatic, flavourful coffee in a matter of minutes.
Suitable for all types of hob, including induction hobs. Dishwasher safe.

Fabricadas em aço inoxidável 18/10 de grande qualidade e resistência.
Design elegante.
Asa formada por um único tubo de aço, que isola do calor.
Válvula de segurança oculta dentro do sistema de fecho.
Alta condutividade térmica. Café aromático e saboroso em poucos minutos.
Aptas para todo o tipo de fogões, incluindo as placas de indução.
Apta para máquinas de lavar louça.



Acabado MATE
SATIN finish



Cafetera Express HYPERLUXE

Cafetière Express
Espressokocher
Express coffee
Cafeteira café expresso

Ref	€	Tazas	U.Venta
62074	59,20	4	1
62076	76,36	6	1
62071	87,26	10	1



Acabado BRILLO
GLOSS finish



Cafetera Express LUXE

Cafetière Express
Espressokocher
Express coffee
Cafeteira café expresso

Ref	€	Tazas	U.Venta
62084	56,54	4	1
62086	66,09	6	1
62081	78,02	10	1

Cafetera Express MOKA

Cafetière Express MOKA
Espressokocher, MOKA
MOKA Express coffee pot
Cafeteira expresso MOKA

Ref	€	Tazas	U.Venta
62054	47,31	4	1
62056	54,16	6	1
62051	64,22	10	1



Asa abatible y pomo de baquelita
Folding handle and Bakelite knob



Cafetera Pava

Cafetière pava
Kaffeekanne Pava
Coffee pot
Chaleira

Ref	€	L	Ø Base (cm)	U.Venta
68215	29,78	1,00	10,0	1
68225	35,90	2,00	13,5	1
68235	43,89	2,80	15,0	1
68205	50,42	4,00	16,0	1



CAFETERAS FRANCESAS



Cafetera clásica manual.
Fabricada en vidrio borosilicato.
Filtro robusto de acero inoxidable 18/10; asegura una buena textura y sabor.
Forma práctica y sencilla de preparar los mejores cafés e infusiones en pocos minutos.
Fácil de limpiar.

Cafetière classique manuelle.
Fabriquée en verre borosilicate.
Filtre robuste en acier inoxydable 18/10; garantit une texture et un goût excellents.
Façon pratique et simple de préparer les meilleurs cafés et infusions en quelques minutes seulement.
Facile à nettoyer.

Klassische Handkaffeemaschine.
Hergestellt in Borosilikatglas.
Robuster Edelstahlfilter 18/10, gewährleistet gute Textur und gutes Aroma.
Praktische und einfache Weise, die besten Kaffees und Infusionen in wenigen Minuten zuzubereiten.
Leicht zu reinigen.

Traditional manual coffee maker.
Made of borosilicate glass.
High strength stainless steel 18/10 filter that ensures good flavour and texture.
An easy and practical way to make the best coffee and tea in just a few minutes.
Easy to clean.

Cafeteira clássica manual.
Fabricada em vidro borossilicato.
Filtro robusto de aço inoxidável 18/10, que assegura boa textura e sabor.
Uma maneira prática e simples de preparar os melhores cafés e infusões em poucos minutos.
Fácil de limpar.

Vidrio borosilicato
Borosilicate glass



Inox 18/10
PP
Polypropileno

Cafetera Francesa BLACK
Cafetière à piston
Französische Kaffeemaschine
French coffee maker
Cafeteira francesa

Ref	€	Tazas	L	U.Venta
62183	7,26	3	0,35	6
62186	11,21	6	0,80	1

Vidrio borosilicato
Borosilicate glass



Inox 18/10
Bambú
Bamboo

Cafetera Francesa WOOD
Cafetière à piston
Französische Kaffeemaschine
French coffee maker
Cafeteira francesa

Ref	€	Tazas	L	U.Venta
62163	9,55	3	0,35	1
62168	12,87	6	0,80	1

Inox

Cafetera cristal
Cafetière en verre
Glaskaffeemaschine
Coffee pot w/glass
Cafeteira vidro

Ref	€	Tazas	L	U.Venta
62153	25,42	2	0,35	1
62180	36,11	6	0,80	1



ABS
plastic
SAN
plastic
BPA free

Varillas Inox
Rods Inox

Batidor Capuccino
Batteur pour Cappuccino
Capuccino-Mixer
Capuccino mixer
Batedor capuccino

Ref	€	W	U.Venta
69041	22,51	2,7	1



▶ CLASSIC

Tetera
Théière
Teekanne
Tea pot
Bule



Ref	€	L	U.Venta
62023	16,39	0,23	12
62035	18,26	0,35	12
62060	24,80	0,60	6
62010	30,50	1,00	1

Cafetera
Cafetière
Kaffeekanne
Coffee pot
Cafeteira



Ref	€	L	U.Venta
62135	19,92	0,35	6
62160	26,77	0,60	6
62110	29,67	1,00	6
62115	41,40	1,50	1
62120	47,62	2,00	1

Lechera
Cremiere
Milchkanne
Creamer
Leiteira



Ref	€	L	U.Venta
62215	7,68	0,15	6
62225	12,14	0,25	6
62235	12,76	0,35	6
62260	14,94	0,60	6
62210	18,68	1,00	6
62216	28,95	1,50	6
62220	34,55	2,00	1

Inox
18/10

▶ ZENIT

Azucarero
Sucrier
Zuckerdose
Sugar bowl
Açucareiro



Ref	€	L	U.Venta
A 62001	13,90	0,23	6
B 62003	17,95	0,35	1

Tetera
Théière
Teekanne
Tea pot
Bule



Ref	€	L	U.Venta
58025	34,47	0,25	1
58060	65,47	0,60	1
58090	75,12	0,90	1
58012	84,76	1,20	1

Inox
18/10

▶ LUXE

Tetera
Théière
Teekanne
Tea pot
Bule



Ref	€	L	U.Venta
65025	33,51	0,25	1
65035	35,38	0,35	1
65060	41,81	0,60	1
65012	52,50	1,20	1

Cafetera
Cafetière
Kaffeekanne
Coffee pot
Cafeteira



Ref	€	L	U.Venta
65135	34,85	0,35	1
65160	41,71	0,60	1
65110	52,91	1,00	1
65118	62,56	1,80	1

Lechera
Cremiere
Milchkanne
Creamer
Leiteira



Ref	€	L	U.Venta
65215	12,66	0,15	6
65235	21,68	0,35	6
65260	26,15	0,60	6
65210	37,45	1,00	1
65218	48,66	1,80	1

Inox
18/10

Azucarero
Sucrier
Zuckerdose
Sugar bowl
Açucareiro



Ref	€	L	U.Venta
65003	28,95	0,35	1
65004	33,62	0,60	1

TETERAS



Teteras fabricadas artesanalmente en hierro fundido de alta calidad muy resistentes. Incluyen infusor extraíble de acero inoxidable. Interior esmaltado para evitar la oxidación. Se recomienda hacer uso de un hervidor para calentar el agua y evitar así que pierda el color.

Théière fabriquée artisanalement en fonte d'aluminium de grande qualité, très résistante. Inclut un infuseur extractible en acier inoxydable. Intérieur émaillé pour éviter l'oxydation. Il est recommandé d'utiliser une bouilloire pour faire chauffer l'eau et ainsi éviter que la théière ne perde sa couleur.

Von Hand gefertigte Teekanne aus hochwertigem Gusseisen, sehr robust. Einschließlich Teefilter aus rostfreiem Stahl. Innen emailiert, um Rostbildung zu vermeiden. Es wird empfohlen, zum Erhitzen des Wassers einen Wasserkocher zu verwenden, damit keine Verfärbungen an der Teekanne auftreten.

This is a high quality, very resistant hand-made, cast iron tea pot. Includes a removable, stainless steel infuser. Interior is enameled to avoid rusting. It's recommended using a boiler to heat the water and thus keep it from losing its colour.

Chalota fabricada artesanalmente em ferro fundido de alta qualidade e muito resistente. Inclui infusor extraível em aço inoxidável. Interior esmaltado para evitar a oxidação. Se recomenda utilizar um fervedor para aquecer a água e assim evitar perdas de cor.



Para los amantes del té
Pour les amateurs de thé
Für Liebhaber von Tee
For tea lovers
Para os amantes de chá

Red



White



Bamboo



Black



Green



Brown



Blue



Tetera
Théière
Teekanne
Tea pot
Bule

Ref	€	L	Color	U.Venta
68663	26,94	0,25	Red	1
68667	34,65	0,50	White	1
68666	28,95	0,60	Bamboo	1
68664	42,23	0,70	Black	1
68662	38,70	0,80	Green	1
68668	31,75	0,80	Brown	1
68661	35,90	1,10	Blue	1
68665	31,85	0,65	Black	1
68669	32,37	1,00	Black	1

Magma (0,65 L)



Magma (1,0 L)



PINZAS PARA TÉ

New



Exprime al máximo cada bolsita de té
Squeezing out the last drop

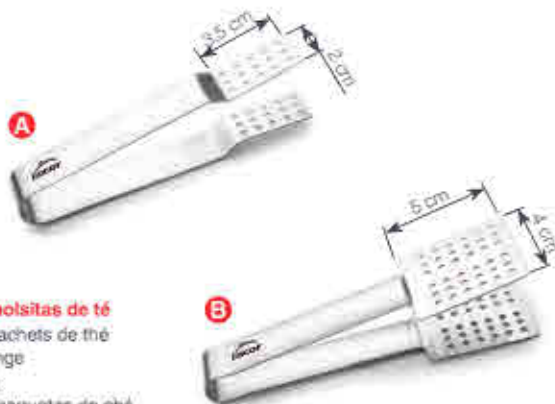

Pinza para bolsitas de té

Pince pour sachets de thé
Teebeutelzange
Tea bag tong
Pinças para saquetas de chá

	Ref	€	L (cm)	U.Venta
A	68078	1,97	13,5	1
B	68079	3,11	14,0	1

Inox
18/10

Exprime fácilmente tu infusión sin riesgo de mancharse o quemarte.
Fabricada en acero inoxidable 18/10 de alta calidad, duradera y resistente al óxido.

Diseñada para una extracción fácil y efectiva de la bolsa de té.

Orificios para exprimir hasta la última gota.

Mango de acero inoxidable para un agarre cómodo y seguro.

Pressez facilement votre infusion sans risque de vous tacher ou de vous brûler.
Fabriquée en acier inoxydable 18/10 de haute qualité, durable et résistante à la rouille.

Conçue pour une extraction facile et efficace des sachets de thé.
Elle dispose de trous pour presser jusqu'à la dernière goutte.

Poignée en acier inoxydable pour une prise en main confortable et sûre.

Drücken Sie Ihre Infusion leicht zusammen, ohne dass Sie sich verfärben oder verbrennen können.

Aus Edelstahl 18/10, haltbar, robust, hochwertig, rostfrei.

So lassen sich Teebeutel einfach und gut aus der Tasse nehmen.

Ablauflöcher zum gründlichen Ausdrücken des Beutels.

Edelstahlg Griff für bequemen und sicheren Griff.

Squeeze easily your infusion without the risk of staining or burning yourself.

Made of high quality 18/10 stainless steel, long lasting and corrosion resistant.

Designed for easy and effective tea bag removal.

Holes for squeezing out the last drop.

Stainless steel handle for a comfortable and safe grip.

Espreme facilmente a sua infusão sem risco de manchar ou queimar-se.

Fabricada em aço inoxidável 18/10 de alta qualidade, durável e resistente ao óxido.

Pensada para retirar fácil e eficazmente os saquinhos de chá.

Os orifícios permitem espremer completamente o saquinho de chá.

Mango de aço inoxidável para uma sujeição confortável e segura.

HERVIDORES



Alto nivel de calidad y resistencia.

Apto para hervir agua o calentar café preparado.

Emite un ligero silbido cuando el agua hierve.

Haut niveau de qualité et de résistance.

Apte pour faire bouillir de l'eau et réchauffer du café préparé.

Émet un léger sifflement lorsque l'eau bout.

Hochwertig und stabil.

Zum Kochen von Wasser oder Erwärmen von Kaffee geeignet.

Wenn das Wasser kocht, ertönt ein akustisches Signal.

High level of quality and resistance.

Suitable for boiling water or heating prepared coffee.

Emits a gentle whistle when the water comes to the boil.

Alto nivel de qualidade e resistência.

Apto para fervor água ou para aquecer café preparado.

Emite um ligeiro silvo quando a água ferve.

Hervidor silbante

Bouillire siffante
Flötenwasserkessel
Whistling kettle
Chaleira com apito

	Ref	€	L	U.Venta
	68619	32,47	2,00	1
	68627	34,24	2,50	1
	68629	36,42	3,00	1
	68639	37,66	4,00	1



Hervidor silbante

Bouillire siffante
Flötenwasserkessel
Whistling kettle
Chaleira com apito

	Ref	€	Color	L	U.Venta
	68643	40,35	Blanco / White	2,50	1
	68644	40,35	Negro / Black	2,50	1



HERVIDORES DE AGUA ELÉCTRICOS

New

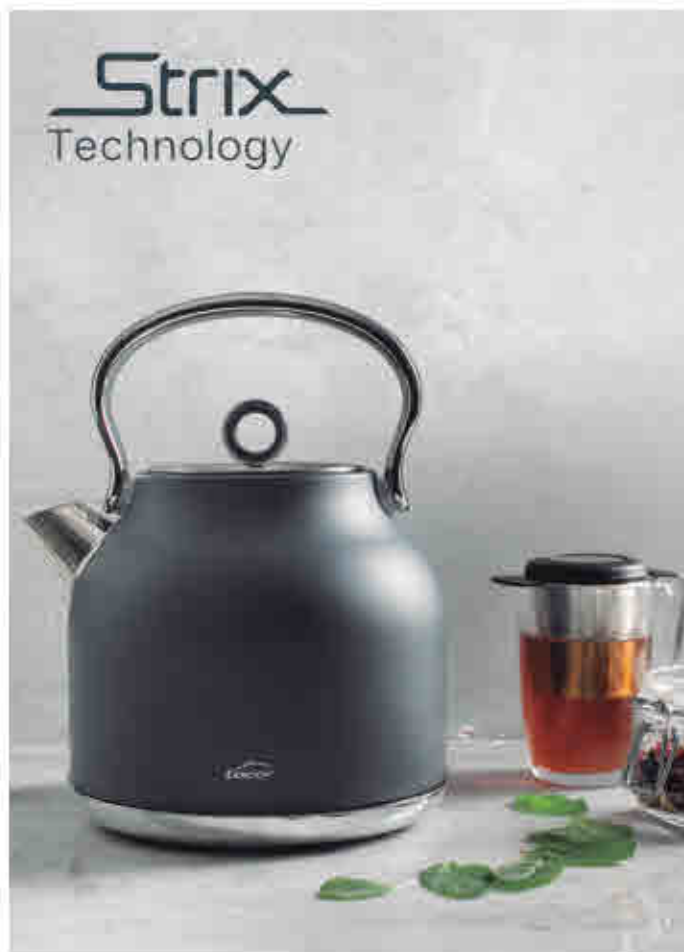

Permite calentar el agua de manera rápida y eficiente

It can be used to heat water quickly and efficiently



Hervidor de agua RETRO
Bouilloire électrique
Elektrische Wasserwamer
Electric kettle
Chaleira eléctrica

Ref	€	W	L	U.Venta
69397	50.11	2200	1.7	1

Ref	Tensión/Voltage	Potencia/Power	Capacidad/Capacity	Dimensiones/Sizes	Peso/Weight
69397	220-240 V , 50/60 Hz	2200 W	1,70 L	26x19,5x26,5 cm	1,20 Kg



Hervidor de agua Retro fabricado en acero inoxidable 18/10, acabado en gris mate. Permite calentar el agua de manera rápida y eficiente. Botón luminoso de encendido/apagado. Base independiente rotativa de 360°. Control STRIX, vida útil superior al controlador estándar. Protección contra el calentamiento en vacío muy preciso. Apagado automático. Visor de nivel de agua. Boquilla con filtro. Mango termo resistente.

Bouilloire Retro fabriquée en acier inoxydable 18/10, finition gris mat. Permet de chauffer l'eau de façon rapide et efficace. Bouton lumineux de marche/arrêt. Base indépendante rotative à 360°. Contrôle STRIX, durée de vie utile supérieure au contrôleur standard. Protection contre la chauffe à vide très précise. Arrêt automatique. Visualisation du niveau d'eau. Buse avec filtre. Poignée thermo-résistante.

Retro Wasserkocher. Material: Edelstahl 18/10. Farbe: Matigrau. Erhitzt Wasser schnell und sparsam. Leuchtender Ein/Ausschalter. Sockel als Einzelteil um 360° drehbar. STRIX Steuerung mit überdurchschnittlicher Lebensdauer. Außerst zuverlässiger Leerlaufschutz. Abschaltautomatik. Wasserstandsanzeige. Düse mit Filter. Griff hitzebeständig.

Retro kettle made of 18/10 stainless steel with a matte grey finish. It can be used to heat water quickly and efficiently. Illuminated on/off button. Independent base rotates 360°. STRIX controller: useful life longer than a standard controller. Very precise protection against heating while empty. Automatic Shut-off. Water level viewer. Nozzle with filter. Heat-resistant handle.

Hervidor de água Retro, fabricado em aço inoxidável 18/10, com acabamento cinzento mate. Permite aquecer a água de maneira rápida e eficiente. Botão luminoso de ligar/desligar. Base independente e rotativa de 360°. Controle STRIX, que proporciona uma vida útil superior à de um controlador standard. Proteção de grande precisão contra o aquecimento em vazio. Desconexão automática. Indicador de nível de água. Bocal com filtro. Asa termorresistente.



Base independiente rotativa de 360°
Independent base rotates 360°



Botón luminoso de encendido/apagado
Illuminated on/off button



Fácil llenado
Easy filling



Interior Inox 18/10
Calentamiento rápido
Interior 18/10 st. steel
Fast heating



Boquilla con filtro
Nozzle with filter



Indicador de nivel de agua
Water level indicator



Filtro extraíble anti-cal
Removable anti-calc filter



Visor de nivel de agua
Water level



Base rotativa de 360°
360° rotating base



Calefactor oculto
Hidden heater

Apagado automático

Se desactiva cuando alcanza el nivel de temperatura deseada

Automatic shutdown

It is deactivated when it reaches the desired temperature level

Botón apertura tapa
Cover opening button



Hervidor de agua GREY

Bouilloire
Wasserwamer
Kettle
Chaleira

Ref	€	W	L	U.Venta
69590	19,09	2200	1,30	1

Luz LED en botón de encendido/apagado
With LED light on the on/off button



Hervidor de agua WHITE

Bouilloire
Wasserwamer
Kettle
Chaleira

Ref	€	W	L	U.Venta
69591	19,09	2200	1,30	1

Ref	Tensión/Voltage	Potencia/Power	Capacidad/Capacity	Dimensiones/Sizes	Peso/Weight
69590	220-240 V; 50/60 Hz	2200 W	1,30 L	20x15x21 cm	0,740 Kg
69591	220-240 V; 50/60 Hz	2200 W	1,30 L	20x15x21 cm	0,740 Kg

Strix
Technology

Botón apertura tapa
Cover opening button



Botón apertura tapa
Cover opening button



Visor de nivel de agua
Water level



Inox
18/10

Hervidor de agua

Bouilloire
Wasserwamer
Kettle
Chaleira

Ref	€	W	L	U.Venta
69277	51,36	2200	1,70	1

Inox
18/10

Hervidor de agua

Bouilloire
Wasserwamer
Kettle
Chaleira

Ref	€	W	L	U.Venta
69291	34,24	1650	1,00	1
69297	42,75	2200	1,70	1

Ref	Tensión/Voltage	Potencia/Power	Capacidad/Capacity	Dimensiones/Sizes	Peso/Weight
69277	220-240 V; 50/60 Hz	2200 W	1,70 L (5 min)	23x16x23 cm	1,00 Kg
69291	220-240 V; 50/60 Hz	1650 W	1,00 L (3 min)	22x16x21 cm	1,10 Kg
69297	220-240 V; 50/60 Hz	2200 W	1,70 L (5 min)	22x18x23 cm	1,65 Kg



Base para conector de 360°. Se apagará automáticamente cuando el agua hierva. **Elemento de calefacción oculto.** Protección de ebullición en seco. **Indicador de luz de encendido/apagado.** La temperatura se puede ajustar de 50°C-95°C. **Botón de apertura de la tapa del hervidor.** Almacenamiento de cable.

Base pour connecteur de 360°. S'éteint automatiquement lorsque l'eau bout. Élément de chauffe caché. Protection d'ébullition à sec. Indicateur lumineux de marche / arrêt. La température peut être réglée entre 50°C et 95°C. Bouton d'ouverture du couvercle de la bouilloire. Rangement du câble.

Grundplatte für eine um 360° drehbare Verbindung. Schaltet sich automatisch ab, wenn das Wasser kocht. Verstecktes Heizelement. Schutz gegen Erhitzen in leerem Zustand. Leuchtanzeige an/aus. Die Temperatur kann zwischen 50°C und 95°C eingestellt werden. Knopf zum Öffnen des Deckels. Kabelaufnahme.

Base for 360° connector. The wireless boiler will automatically switch off when the water boils. Hidden heating element. Dry boil protection. ON/OFF light. The temperature can be adjusted from 50°C - 95°C. Button for opening the boiler cap. Cable storage.

Base para conector de 360°. Desligar-se-á automaticamente quando a água ferver. Elemento de aquecimento oculto. Proteção de ebullicão a seco. Indicador de luz de ligação/desligação. A temperatura pode ser ajustada de 50°C a 95°C. Botão de abertura da tampa do aquecedor. Armazenamento do cabo.

Inox 18/10 | **C**
Glass

Hervidor de agua
Bouilloire
Wasserwärmer
Kettle
Chaleira

Ref	€	W	L	U.Venta
69292	68,15	2200	1,70	1

Ref	Tensión/Voltage	Potencia/Power	Temperatura/Temp.	Capacidad/Capacity	Dimensiones/Sizes	Peso/Weight
69292	220-240 V; 50 Hz	2200 W	50 - 95°C	1,70 L	23x23x32 cm	1,90 Kg



Tapa extraíble con cierre
Removable lid with closure



Indicador de capacidad máxima
Maximum capacity indicator



Tapa extraíble con cierre
Removable lid with closure



Indicador de capacidad máxima
Maximum capacity indicator



Interior Inox 18/10
Calentamiento rápido
Interior 18/10-st. steel
Fast heating



Base independiente rotativa de 360°
Independent base rotates 360°

CE
Ceramic

Hervidor de agua cerámico GALA
Bouilloire en céramique
Keramik Wasserwärmer
Ceramic kettle
Chaleira cerâmica

Ref	€	W	L	U.Venta
69276	43,68	1500	1,20	1

CE
Ceramic

Hervidor cerámico eléct. GALA GREY
Bouilloire électrique en céramique
Keramik Elektrische Wasserwärmer
Ceramic electric kettle
Chaleira eléctrica cerâmica

Ref	€	W	L	U.Venta
69289	47,73	1200	1,0	1



Base independiente rotativa de 360°
Independent base rotates 360°

New

Ref	Tensión/Voltage	Potencia/Power	Capacidad/Capacity	Dimensiones/Sizes	Peso/Weight
69276	220-240 V; 50/60 Hz	1500 W	1,2 L	24x17x25 cm	1,68 Kg
69289	220-240 V; 50/60 Hz	1200 W	1,0 L	23x16,5x23 cm	1,40 Kg

▶ DISPENSADOR DE AGUA CALIENTE INSTANT



Ideal para oficinas, casas rurales, reuniones, etc.
Fácil llenado. Depósito extraíble de gran capacidad (2L) para llenar fácilmente el contenedor.
Display intuitivo. Elige la cantidad de agua (150 ml - 230 ml - 300 ml) y la temperatura deseada (25°C - 70°C - 85°C - 95°C).
Cuenta con función de bloqueo de seguridad.
Ahorra tiempo y energía. Proporciona la cantidad exacta de agua caliente deseada, el agua restante del depósito se mantendrá fría.
Bandeja de goteo extraíble e imantada, fácil de limpiar y colocar.

Ideal pour les bureaux, les gîtes ruraux, les réunions, etc.
Remplissage facile. Réservoir extractible de grande capacité (2L) pour remplir facilement le conteneur.
Écran intuitif. Choisissez la quantité d'eau (150 ml - 230 ml - 300 ml) et la température souhaitée (25°C - 70°C - 85°C - 95°C).
Dispose d'une fonction de blocage de sécurité.
Gain de temps et économies d'énergie. Fournit la quantité exacte d'eau chaude souhaitée, l'eau restante dans le réservoir restera froide.
Plateau d'écoulement extractible et aimanté, facile à nettoyer et à installer.

Ideal für Büros, Landhäuser, Sitzungen usw.
Einfaches Füllen. Herausnehmbarer Tank mit großem Fassungsvermögen (2L) zum einfachen Füllen des Behälters.
Intuitives Display. Wassermenge (150 ml - 230 ml - 300 ml) und erwünschte Temperatur (25°C - 70°C - 85°C - 95°C) wählbar.
Mit Sicherheitssperre.
Spart Zeit und Energie. Spendet genau die erwünschte Menge heißes Wasser, im Tank bleibendes Wasser bleibt kalt.
Herausnehmbare und magnetische Tropfwanne, einfach zu reinigen und anzubringen.

Perfect for offices, country homes, meetings, etc.
Easy to fill. Large capacity (2L) removable tank to easily fill the container.
Intuitive display. Choose the amount of water (150 ml - 230 ml - 300 ml) and the desired temperature (25°C - 70°C - 85°C - 95°C).
Includes safety lock feature.
Save time and energy. Provides the exact amount of hot water desired, while the remaining water in the tank remains cold.
Removable and magnetic drip tray, easy to clean and replace.

Ideal para escritórios, casas de turismo rural, reuniões, etc.
Fácil de encher. Depósito extraível de grande capacidade (2L) para encher facilmente o recipiente.
Ecrã intuitivo. Selecione a quantidade de água (150/230/300 ml) e a temperatura desejada (25/70/85/95 °C).
Função de bloqueio de segurança.
Poupa tempo e energia. Proporciona a quantidade exata de água quente desejada, a água restante do depósito manter-se-á fria.
Bandeja de gotejamento extraível e magnética, fácil de limpar e de colocar.

Display intuitivo
Intuitive display

Bandeja de goteo extraíble e imantada
Removable and magnetic drip tray



Agua caliente en 5 segundos
Hot water in 5 seconds



Dispensador de agua caliente

Distributeur d'eau chaude
 Heißwasserspender
 Hot water dispenser
 Dispensador de água quente

Ref	€	W	U.Venta
69298	105,20	2400	1

Ref	Tensión/Voltage	Potencia/Power	Capacidad/Cap.	Niveles Calentamiento Heating levels	Dispensado agua Water dispensed	Dimensiones/Sizes	Peso/Weight
69298	220-240 V / 50-60 Hz	2400 W	2.00 L	25°C - 70°C - 85°C - 95°C	150-230-300 ml	32x16.8x32.7 cm	2.50 Kg

Termos · Botellas
Thermos · Bottles

#CocinaConLacor



JARRAS TERMO POLIPROPILENO



Ideal para café, leche o té
Conserva la temperatura durante más tiempo
 Ideal for coffee, milk or tea
 Keeps liquids at the right temperature for longer



Tapa aislante con pulsador de apertura.
 Irrompible, libre de malos olores.
 Fabricado en resina especial para soportar los golpes.

Insulating lid with button for opening.
 Shatterproof, free of bad smells
 Manufactured in special resin to resist bangs

Triple pared aislante
 Triple insulating wall



Jarra Termo
 Pichet thermo
 Thermoskanne
 Termo jug
 Jarra termo

Ref	€	L	U.Venta
62496	23,34	0,60	1
62491	33,30	1,20	1
62492	41,92	2,00	1



Jarra termo que mantiene los líquidos calientes y fríos durante horas.
Ideal para servir café, leche o té.
Boca amplia; facilita su llenado y su limpieza.
Tapa aislante de rosca con botón de apertura que mantiene el calor y dispensa fácilmente las bebidas.
Uso muy sencillo y eficaz, podrás manejarlo con una sola mano.

Pichet thermos qui maintient les liquides chauds et froids pendant des heures idéal pour servir le café, lait ou le thé.
 Bac large - facilite son remplissage et son nettoyage
 Couverture isolant à vis avec poussoir d'ouverture qui maintient la chaleur et distribue facilement les boissons.
 Utilisation très simple et efficace - peut être manipulé avec une seule main

Thermokanne hält Getränke stundentlang kalt oder heiß.
 Ideal für Kaffee, Milch oder Tee.
 Isolierender Schraubverschluss mit Druckknopf-Auslass für besseren Wärmerhalt und einfachen Ausschank
 Einfacher und schneller Gebrauch, Einhandbedienung

Thermos jug that keeps liquids hot and cold for hours.
 Ideal for coffee, milk or tea.
 Insulated screw cap with opening button for easy pouring and to keep the heat in the jug.
 Very simple and efficient to use, can be held in one hand.

Jarra térmica, que mantém os líquidos quentes ou frios durante horas.
 Ideal para servir café, leite ou chá.
 Bico de servir amplo, para facilitar o seu enchimento e a limpeza.
 Tampa isoladora de rosca, com botão de abertura, que mantém o calor e dispensa facilmente as bebidas.
 Utilização simples e eficaz, que permite utilizá-la com uma só mão.

New



Capa de vidro (interior)
 Glass layer (interior)

Doble pared de aislamiento,
no transmite el calor o el frío
 Double insulating wall,
 does not transmit heat or cold



Jarra termo GREY
 Verseuse isothermo
 Thermoskanne, isoliert
 Vacuum flask
 Servidor termo

Ref	€	L	U.Venta
62563	12,04	1,00	1
62564	14,11	1,50	1

New

Capa de vidro (interior)
 Glass layer (interior)

Doble pared de aislamiento,
no transmite el calor o el frío
 Double insulating wall,
 does not transmit heat or cold



Jarra termo WHITE
 Verseuse isothermo
 Thermoskanne, isoliert
 Vacuum flask
 Servidor termo

Ref	€	L	U.Venta
62575	12,14	1,00	1
62579	14,11	1,50	1

JARRAS TERMO INOX 18/10



Inox
18/10



Jarra termo que mantiene los líquidos calientes y fríos durante horas. Ideal para servir té o café.

Interior y exterior en acero inoxidable de gran calidad.

Doble pared que proporciona un alto rendimiento térmico.

Boca amplia; facilita su llenado y su limpieza.

Tapa aislante de rosca con pulsador de apertura que mantiene el calor y dispensa fácilmente las bebidas.

Pichet thermos qui maintient les liquides chauds et froids pendant des heures. Idéal pour servir le thé ou le café.

Intérieur et extérieur en acier inoxydable de grande qualité.

Double paroi qui confère un haut rendement thermique.

Bec large : facilite son remplissage et son nettoyage.

Couvercle isolant à vis avec poussoir d'ouverture qui maintient la chaleur et distribue facilement les boissons.

Thermo jug that keeps liquids hot and cold for hours.

Ideal for serving tea or coffee.

High-quality stainless steel interior and exterior.

Double wall that provides high thermal performance.

Wide mouth makes it easy to fill and clean.

Insulated screw cap with opening button that retains heat and easily dispenses drinks.

New



Jarra termo

Verseuse isothermo

Thermoskanne, isoliert

Vacuum flask

Servidor termo

Ref	€	L	U.Venta
62522	47,73	1,6	1
62523	43,37	2,2	1

Jarra termo WHITE/BLACK

Verseuse Isothermo

Thermoskanne, isoliert

Vacuum flask

Servidor termo



Ref	€	Color	L	U.Venta
62483	26,87	Blanco / White	1,00	1
62484	26,87	Negro / Black	1,00	1

Jarra Termo

Bouteille thermo

Thermoskanne

Insulated server

Jarra termo



Ref	€	L	U.Venta
62430	48,45	0,30	1
62460	53,54	0,60	1
62410	59,24	1,00	1
62415	76,36	1,50	1

HINWEIS : In Deutschland nicht verfügbar

Jarra termo

Verseuse isothermo

Thermoskanne, isoliert

Vacuum flask

Servidor termo



Ref	€	L	h (mm)	U.Venta
62481	25,83	1,00	160	1
62485	30,50	1,50	200	1
62486	31,33	2,00	220	1

Termo Hermético

Hermetic cap



Jarra Termo LUXE

Bouteille thermo

Thermoskanne

Insulated server

Jarra termo Luxe

Ref	€	L	U.Venta
63360	58,20	0,60	1
63310	63,29	1,00	1
63315	73,04	1,50	1
63320	77,92	2,00	1

AIRPOT

Boca ancha
para cubitos hielo
Wide mouth for ice cubes



Air pot

Air pot
Getränkesperder, isoliert
Air pot
Air pot

Ref	€	L	h (cm)	U.Venta
62472	58,83	2,50	32,5	1
62473	63,70	3,00	34,5	1
62475	85,49	4,00	39,0	1

NO utilizar con bebidas gaseosas ni lácteos - Do NOT use with fizzy drinks or dairy



Mantiene las bebidas calientes o frías. Ligero e irrompible.
NO utilizar con bebidas gaseosas ni lácteos.

Maintient les boissons chaudes ou froides. Léger et incassable.
NE PAS utiliser avec des boissons gazeuses ni des produits laitiers.

Hält die Getränke warm oder kalt. Leicht und unzerbrechlich.
NICHT mit Getränken mit Kohlensäure oder Milchprodukten verwenden.

Keeps drinks hot or cold. Light and shatterproof!
Do NOT use with fizzy drinks or dairy.

Mantém as bebidas quentes e frias. Leve e inquebrável.
NÃO utilizar com bebidas gasosas nem lácteos.

TERMOS BALA



Termo para líquidos

Thermo pour liquides
Thermobehälter für Flüssigkeiten
Thermo for liquids
Termo para líquidos

Ref	€	L	h (cm)	U.Venta
62441	10,48	0,35	20,0	1
62442	11,83	0,50	24,8	1
62443	16,08	0,75	29,8	1
62444	17,33	1,00	33,7	1



Mantiene las bebidas calientes o frías hasta 24 horas.
Doble pared y cámara de vacío. Alto rendimiento térmico.

Maintient les boissons chaudes ou froides jusqu'à 24 heures.
Haut rendement thermique. Double pari et chambre à vide.

Hält die Getränke 24 Stunden heiß oder kalt.
Thermisch leistungsstark. Doppelwände und Vakuumkammer.

Keeps drinks hot or cold up to 24 hours
High thermal efficiency. Double wall and vacuum chamber.

Mantém as bebidas quentes e frias por até 24 horas.
Alto desempenho térmico. Parede dupla e câmara de vácuo.

Termo SOFT TOUCH BLACK

Thermo Soft Touch
Thermobehälter Soft Touch
Thermo Soft Touch
Termo Soft Touch



Ref	€	Ø (cm)	L	U.Venta
62476	11,93	8x22	0,35	1
62477	13,49	8x27	0,50	1

Termo SOFT TOUCH WHITE

Thermo Soft Touch
Thermobehälter Soft Touch
Thermo Soft Touch
Termo Soft Touch



Ref	€	h (cm)	L	U.Venta
62576	11,10	19	0,35	1
62577	12,35	24	0,50	1
62578	15,25	28	0,75	1

TERMOS PARA ALIMENTOS

Termo para alimentos sólidos

Thermo pour aliments solides
Thermobehälter für feste Speisen
Thermo for solid food
Termo para alimentos sólidos



Ref	€	L	h (cm)	U.Venta
A 62448	18,16	0,70	19,7	1
B 62440	21,68	1,00	23,5	1

Termo para alimentos SOFT TOUCH

Thermo pour aliments
Thermobehälter für Speisen
Thermo for food
Termo para alimentos



Ref	€	h (cm)	L	U.Venta
62480	44,82	18	1,40	1

BOTELLAS EDAN

Botella Inox EDAN BLACK

Bouteille inox
Stahlfflasche
Stainless steel bottle
Garrafa de aço inoxidável

Ref	€	L	U.Venta
62536	9,75	0,26	1
62537	10,69	0,50	1
62538	13,18	0,75	1



Fabricada en acero inoxidable. Interior de acero inoxidable 18/10.
Bebidas frías y calientes durante horas.
Doble pared de aislamiento, no transmite el calor o el frío.
Tapa hermética, anti derrames.
No transmite sabores ni olores.

Fabricada en acier inoxydable. Intérieur en acier inoxydable 18/10.
Boissons chaudes et froides pendant des heures.
Double paroi isolante, ne transmet ni la chaleur ni le froid.
Couvercle hermétique, anti écoulements.
Ne transmet ni goûts ni odeurs.

Aus Edelstahl, Innenraum aus Edelstahl 18/10.
Heiße und kalte Getränke für Stunden.
Dank doppelwandiger Isolation wird die Flasche außen weder warm noch kalt.
Äußerst dichter und ausleutsicherer Deckel.
Überträgt keinen Geschmack/Genuch.

Made of stainless steel. 18/10 stainless steel interior.
Hot and cold drinks for hours.
Double insulating wall; does not transmit heat or cold.
Airtight, non-spill cap.
Does not transmit flavours or smells.

Feito de aço inoxidável. Interior em aço inoxidável 18/10.
Bebidas geladas e quentes durante horas.
Paredes isolantes duplas, não transmite calor ou frio.
Tampa hermética, sem derramamento.
Não transmite sabores ou cheiros.

Botella Inox EDAN RED

Bouteille inox
Stahlfflasche
Stainless steel bottle
Garrafa de aço inoxidável

Ref	€	L	U.Venta
62546	9,75	0,26	1
62547	10,69	0,50	1
62548	13,18	0,75	1



BOTELLAS ENERGY



Botella Personal ENERGY

Personnelle bouteille
Persönliche Flasche
Personal bottle
Garrafa pessoal

Ref	€	L	U.Venta
61950	12,24	0,50	1
61965	13,28	0,65	1



Tapón con doble protección a prueba de goteo.
Abra la botella con una mano y un sólo clic. Boca ancha para meter hielo fácilmente.
Correa de transporte resistente.
Botella fabricada en tritán (500 ml / 650 ml). Material libre de BPA.
Duradera y resistente al impacto.

Bouchon avec double protection anti-goutte.
Ouvrez la bouteille d'une seule main et d'un seul clic. Ouverture large pour remplir facilement de glace.
Courroie de transport résistante.
Bouteille fabriquée en Tritan (500 ml / 650 ml). Matériau sans BPA.
Durable et résistante aux chocs.

Doppelt abgedichteter Deckel mit Auslaufschutz.
Öffnet sich einhändig mit einem Klick. Breite Öffnung zum Einfüllen von Eis.
An robustem Trageband.
Flasche aus Tritan (500 ml / 650 ml). BPA-freies Material.
Langlebig und stoßfest.

Drip proof double protected lid.
Open the bottle with just one hand and a click. Wide mouth for easy filling with ice.
Strong carrying strap.
Bottle is made from Tritan (500 ml / 650 ml). BPA free material.
Long lasting and impact resistant.

Tampão com dupla proteção, à prova de gotejamento.
Garrafa fácil de abrir com uma só mão e um só clique. Boca larga para encher facilmente gelo.
Correia de transporte resistente.
Garrafa fabricada em Tritan (500 ml / 650 ml). Material que não contém BPA.
Durável e resistente ao impacto.

Válido para las botellas Energy / Edan
Valid for Energy / Edan bottles



Funda neopreno
Manchon neoprene
Neopren hülle
Neoprene sleeve
Luva de neoprene

Ref	€	U.Venta
R69382F	5,29	1

Bar - Bodega
Bar - Wine Cellar

#CocinaConLacor



FUNDAS ENFRIABOTELLAS

New



Funda enfriabotellas

Housse de refroidissement de bouteilles
Flaschenkühler
Bottle cooler cover
Arrefecedor de garrafas

	Ref.	€	cm	Color	U.Venta
A	62276	12,66	15x23	DENIM	1
B	62277	12,66	15x23	BLACK	1



Funda térmica, enfría y mantiene la temperatura durante más tiempo. Tamaño universal y laterales elásticos, se adapta a todo tipo de botellas. Cubre prácticamente toda la botella, desde la base hasta al cuello. Meter la funda térmica en el congelador antes de su uso. Para lavarlo, utilizar un paño húmedo. No apto para el lavavajillas.

Housse thermique qui permet de refroidir et de maintenir la température idéale du vin ou du cava pendant plus longtemps.

Taille universelle et côtés élastiques, s'adapte parfaitement à tout type de bouteilles. Couvre pratiquement toute la bouteille, de la base au goulot. Mettez la housse thermique dans le congélateur avant utilisation. Pour la laver, utilisez un chiffon humide. Ne pas mettre au lave-vaisselle.

Thermohülle kühlt und hält die Temperatur ideal um Wein oder Sekt länger temperiert zu halten. Universalgröße und Seitliche Elastikzüge passen sich perfekt an jede Flaschenart an. Hülle reicht vom Boden bis zum Hals praktisch ganz über die Flasche. Legen Sie die Thermohülle vor dem Gebrauch in den Gefrierschrank. Mit einem feuchten Lappen reinigen. Nicht spülmaschinengeeignet.

Insulated cover for keeping wine or cava cool and at the perfect temperature for more time.

Universal size and elastic sides fit all kinds of bottles perfectly.

It covers practically the whole bottle from the neck to the base.

Put the thermal cover in the freezer before use.

Use a damp cloth to clean it. Not dishwasher safe.

Capa térmica, que permite amolecer a garrafa e manter a temperatura ideal para manter o vinho ou espumante frios durante mais tempo. Tamanho universal e os lados elásticos adaptam-se perfeitamente a todo o tipo de garrafas. Cobre praticamente toda a garrafa, da base ao gargalo. Coloque a capa térmica no freezer antes de usar. Limpar com um pano húmido. Este artigo não é apto para máquinas de lavar louça.



Enfriador de botellas

Rafraîchisseur à bouteilles
Flaschenkühler
Bottle cooler
Arrefecedor de garrafas

	Ref.	€	U.Venta
A	62325	9,03	6
B	62355	9,55	6



Enfría en pocos minutos y dura horas. Se adapta a la mayoría de las botellas (0,7 - 1,0 L). Antes de utilizarlo, meter en el congelador por espacio de 5 horas.

Re/froidit en quelques minutes et pendant des heures. S'adapte à la plupart des bouteilles (0,7 - 1,0 L). Avant son utilisation, mettez au congélateur pendant 5 heures.

Cools in a few minutes and lasts hours. Adapts to the majority of bottles (0.7 - 1.0 L). Before using it, place in the freezer for 5 hours.

BOTELLERO

Asa de piel de vacuno acabado en curtido vegetal
Vegetable-tanned cow leather finish handle



Botellero NATURA

Range-bouteilles
Flaschentasche
Bottle rack
Porta-garrafas

Ref.	€	Ø (cm)	h (cm)	a (mm)	U.Venta
63483	19,61	10	25	0,55	1



Fabricada en fibra virgen natural. Material ecológico y respetuoso con el medio ambiente. Lavable, resistente y duradera. Diseñada y fabricada en España. Hecha a mano. Tacto agradable y suave, similar a la piel.

Fabricades en fibres vierges naturelles. Matériau écologique et respectueux de l'environnement. Lavables, résistantes et durables. Conçues et fabriquées en Espagne. Faites à la main. Toucher agréable et doux, similaire au cuir.

Made of natural virgin fibre. Ecological material respectful with the environment. Washable, resistant and durable. Designed and manufactured in Spain. Handmade. Nice soft feel, similar to leather.

▶ SOPORTE ENFRIABOTELLAS

Compatible con:
Compatible with:

62315
62320
62322
62321
61321
61319
14121
62365
62361
62362
65418
65420
65618
65620



Inox

Pie Porta-cubos

Porte-seau à champagne
Sektkühlerstand
Wine cooler stand
Pé porta baldes

Ref	€	Ø (cm)	h (cm)	U.Venta
62300	76,67	20	65	1



Inox

Pie Porta-cubos oval

Porte-oval seau à champagne
Sektkühlerstand, oval
Oval wine cooler stand
Pé porta baldes oval

Ref	€	cm	h (cm)	U.Venta
62342	109,04	30x20	64	1



Inox

Soporte de mesa enfriabotellas

Support seau à champagne
Tischhalterung für Sektkühler
Wine cooler table support
Suporte balde de gelo arrefecedor

Ref	€	Ø (cm)	U.Venta
62478	11,00	18	1
62479	11,10	20	1

▶ ENFRIABOTELLAS INOX



Inox
18/10



Enfriabotellas doble pared INOX

Seau à champagne isothermie
Champagnerkühler
Double champagne cooler
Arrefecedora de garrafas parede dupla

Ref	€	Ø (cm)	h (cm)	U.Venta
62389	26,66	10,5	19,5	1

Se adapta a la mayoría de las botellas de vino o champán

Fits most bottles of red wine or champagne



Doble pared aislante
Double insulating wall



Acabado en MATE
MATT finish



Inox

Cubo enfriachampán oval

Seau à champagne oval
Champagnerkühler, oval
Oval champagne cooler
Balde arrefecedor oval

Ref	€	cm	h (cm)	L	U.Venta
62338	69,93	30x20	20	7,00	1



Inox
18/10



Enfriabotellas doble pared

Seau à champagne isothermie
Champagnerkühler, isoliert
Double champagne cooler
Arrefecedora de garrafas parede dupla

Ref	€	Ø (cm)	Ø Int. (cm)	h (cm)	U.Venta
62356	14,21	12,5	9,50	20	1

Acabado SOFT TOUCH
SOFT TOUCH finish



Doble pared aislante
Double insulating wall

Inox
18/10



Cubo de hielo-champán LUXE asa Inox

Seau à glace-champagne "Luxe anse inox"
Sekt Kühler Luxe
Wine cooler "Luxe" inox handle
Balde arrefecedor Luxe asa inox

Ref	€	Ø (cm)	h (cm)	L	U.Venta
62315	27,08	14	12,0	1,20	1
62320	36,73	20	19,0	4,50	1
62322	44,20	22	20,0	5,50	1

Inox



Cubo de hielo

Seau à champagne
Sekt Kühler
Wine cooler
Balde de gelo



Ref	€	Ø (cm)	h (cm)	L	U.Venta
14121	16,50	20	20	4,00	1

Barreño oval

Bassine oval
Glatwanne
Oval cooler
Bacia oval



Ref	€	cm	h (cm)	L	U.Venta
62271	50,11	43x30	20	20,00	1
62272	60,28	53x38	25	27,00	1
62273	70,55	61x43	28	32,00	1

Inox
18/10

Enfriachampán

Refráichisseur à champagne
Champagnerkühler
Champagne cooler
Champanheiro



Ref	€	Ø (cm)	h (cm)	L	U.Venta
62346	73,97	36	20,5	13,0	1

Inox
18/10

Cubo enriabotellas

Seau à vin
Champagnerkühler
Wine bucket
Balde enriá-garralás



Ref	€	Ø Sup. (cm)	Ø (cm)	h (cm)	L	U.Venta
62321	54,26	21	18	20	5,50	1

Inox

Cubo cónico asas soldadas

Seau à glace en inox
Sekt Kühler, Rostfrei
Stainless steel wine cooler w/welded handles
Balde cónico Asas soldadas



Ref	€	Ø (cm)	h (cm)	L	U.Venta
61321	21,17	20	21	4,25	1

Inox

Cubo cónico asas incorporadas

Seau à glace en inox
Sekt Kühler, Rostfrei
St. steel wine cooler w/fix handles
Balde cónico Asas incorporadas



Ref	€	Ø (cm)	h (cm)	L	U.Venta
61319	22,93	20	22	4,75	1

Inox
18/10

Champanero Dorado

Refráichisseur à champagne
Champagnerkühler
Champagne cooler
Champanheiro Dourado



Ref	€	Ø (cm)	h (cm)	L	U.Venta
62336	111,74	36	28	11,50	1

Inox
18/10

Champanero LUXE

Refráichisseur à champagne LUXE
Champagnerkühler LUXE
LUXE champagne cooler
Champanheiro LUXE



Ref	€	Ø (cm)	h (cm)	L	U.Venta
62436	103,34	36	23	11,50	1
62439	112,78	40	26	15,00	1

▶ COLECCIÓN MOON

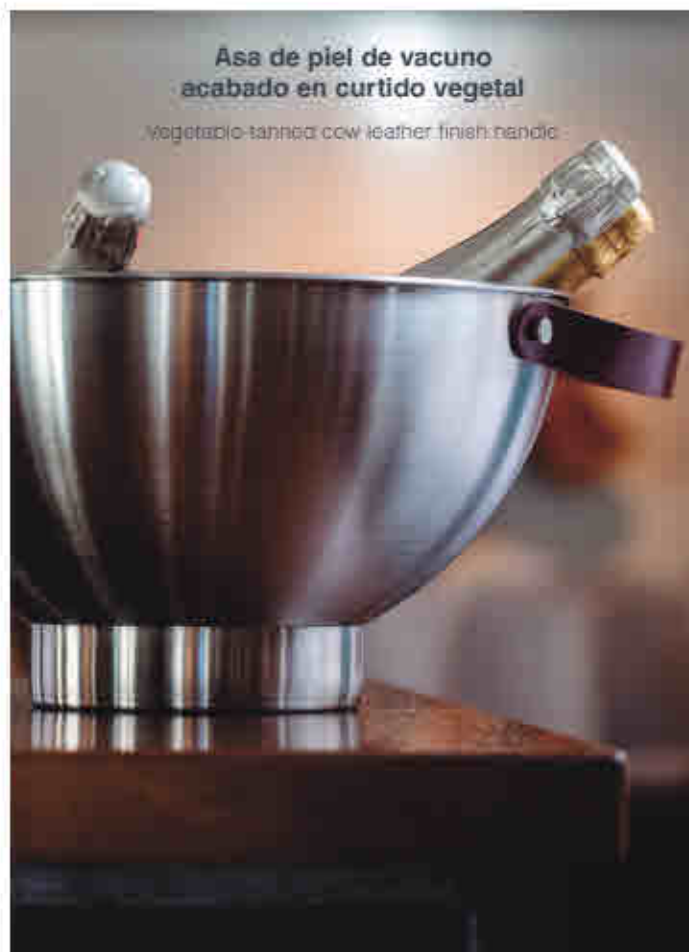

Asa de piel de vacuno acabado en curtido vegetal

vegetable-tanned cow leather finish handle

Inox
18/10

Cuerpo de Acero inoxidable 18/10, resistente a la corrosión.
Diseño elegante y actual.
Muy cómodo y fácil de desplazar gracias a su asa de cuero.
Asa de piel vacuno acabado en curtido vegetal de 3 mm de grosor.
Acabado exterior negro mate e interior lijado o exterior e interior lijado.

Corps en acier inoxydable 18/10, résistant à la corrosion.
Style élégant et actuel. Très pratique et facile à déplacer grâce à sa anse en cuir.
Anse en peau de vache avec un tannage végétal de 3 mm d'épaisseur.
Finition extérieure noir mat et intérieur brossé ou extérieur et intérieur brossé.

Körper aus Edelstahl 18/10, korrosionsbeständig.
Elegantes und aktuelles Design. Dank der beiden Ledergriffe sehr bequem und einfach zu handhaben.

Griff aus pflanzlich gegerbtem Rindleder, 3 mm dick.
Außen mattschwarz und innen poliert oder außen und innen poliert.

18/10 corrosion resistant stainless steel body.
It has an elegant and modern design. Leather handles make it very easy and comfortable to move around.

The handle has a 3 mm thick vegetable-tanned cow leather finish.
Matte black outside and brushed inside or brushed inside and outside.

Em aço inoxidável 18/10, resistente à corrosão.
Design elegante e atual. Prática e fácil de mover, graças à asa de couro.
Asa em pele de bovino com acabamento em curtido vegetal de 3 mm de espessura.
Acabamento exterior negro mate e interior polido, e acabamento exterior e interior polido.

Cubitera MOON BLACK

Seau à glace
Sektkühler
Ice bucket
Porta-cubos de gelo



Ref.	€	Ø (cm)	h (cm)	L	U.Venta
65414	34,03	14	12	15	1

Cubitera MOON INOX

Seau à glace
Sektkühler
Ice bucket
Porta-cubos de gelo



Ref.	€	Ø (cm)	h (cm)	L	U.Venta
65614	29,47	14	12	15	1

Enfriabotellas MOON BLACK

Seau à champagne
Champagnerkühler
Wine bucket
Arrefecedora de garrafas



Ref.	€	Ø (cm)	h (cm)	L	U.Venta
65418	40,36	18	19,0	4,0	1
65420	48,24	20	19,5	5,6	1

Enfriabotellas MOON INOX

Seau à champagne
Champagnerkühler
Wine bucket
Arrefecedora de garrafas



Ref.	€	Ø (cm)	h (cm)	L	U.Venta
65618	37,35	18	19,0	4,0	1
65620	44,82	20	19,5	5,6	1



Champanero MOON BLACK

Refräichisseur ä champagne
Champagnerkühler
Champagne cooler
Champanheiro

Ref	€	Ø (cm)	h (cm)	L	U.Venta
65436	102,51	36	20,5	11,5	1



Champanero MOON INOX

Refräichisseur ä champagne
Champagnerkühler
Champagne cooler
Champanheiro

Ref	€	Ø (cm)	h (cm)	L	U.Venta
65636	102,51	36	20,5	11,5	1

Mäs visibilidad y
accesibilidad
More visibility and
accessibility



Mäs visibilidad y
accesibilidad
More visibility and
accessibility



Champanero inclinado MOON BLACK

Refräichisseur ä champagne incliné
Schräger Champagnerkühler
Inclined champagne cooler
Champanheiro inclinado

Ref	€	Ø (cm)	h (cm)	L	U.Venta
65440	101,47	40	27	15	1

Champanero inclinado MOON INOX

Refräichisseur ä champagne incliné
Schräger Champagnerkühler
Inclined champagne cooler
Champanheiro inclinado

Ref	€	Ø (cm)	h (cm)	L	U.Venta
65640	101,47	40	27	15	1



Barreño MOON BLACK

Bassine
Glatwanne
Mirror cooler
Bacia

Ref	€	Ø (cm)	h (cm)	L	U.Venta
65450	89,85	50	21	30	1



Barreño MOON INOX

Bassine
Glatwanne
Mirror cooler
Bacia

Ref	€	Ø (cm)	h (cm)	L	U.Venta
65650	89,85	50	21	30	1

ENFRIABOTELLAS ACRÍLICAS



Cubo enfriabotellas negro acrílico

Seau à vin noir acrylique
Acryl Champagnerkühler
Acrylic black wine bucket
Biade arrefecedora de garrafas negro acrílico

	Ref	€	Base	Boca	h (cm)	L	U.Venta
A	62354	29,26	13,5x16	20,5x25,5	28,5	4,00	1
	62367	29,26	16x12	27x20	20,0	3,00	1
B	62368	42,23	21x15,5	35x26,5	26,0	7,00	1

Cubo enfriabotellas acrílico flor

Seau à vin acrylique fleur
Champagnerkühler, Acryl, Blume
Flower acrylic wine bucket
Biade arrefecedora de garrafas Acrílico flor

Ref	€	cm	h (cm)	L	U.Venta
62364	15,16	22x18	23	3,00	1



Cubo enfriabotellas doble con asas

Seau Isotherme double avec anse
Acryl Champagnerkühler
Acrylic wine cooler with handle
Biade arrefecedora de garrafas acrílico

Ref	€	Base	Boca	h (cm)	L	U.Venta
62365	28,12	13,5x16	20,5x25,5	28,5	4,50	1



Cubo enfriabotellas doble

Seau Isotherme double
Acryl Champagnerkühler
Acrylic wine cooler
Biade arrefecedora de garrafas dupla

Ref	€	Base	Boca	h (cm)	L	U.Venta
62366	33,82	13,5x18,5	21,5x30,5	26	5,50	1



Enfriabotellas MAX

Seau à champagne
Champagnerkühler
Champaig cooler
Arrefecedora de garrafas

Ref	€	cm	h (cm)	L	U.Venta
62274	35,48	31,7x21,5	24,6	8,0	1



Cubo enfriabotellas RING

Seau à vin
Champagnerkühler
Vine bucket
Biade arrefecedora de garrafas

Ref	€	cm	h (cm)	L	U.Venta
62275	30,50	23,2x22	24,6	3,5	1



Cubo enfriabotellas

Seau à vin
Champagnerkühler
Vine bucket
Biade arrefecedora de garrafas

	Ref	€	Ø (cm)	h (cm)	L	U.Venta
A	62361	5,40	18	15	1,50	1
B	62362	10,17	22	21	3,50	1
C	62371	23,34	33	25	10,00	1

Enfriabotellas

Seau à champagne
Champagnerkühler
Champaig cooler
Arrefecedora de garrafas

Ref	€	cm	h (cm)	L	U.Venta
62373	25,63	47x29	23	13,00	1



JARRA INFUSORA

Ideal para preparar bebidas de frutas 100% naturales
Ideal for preparing 100% natural fruit drinks

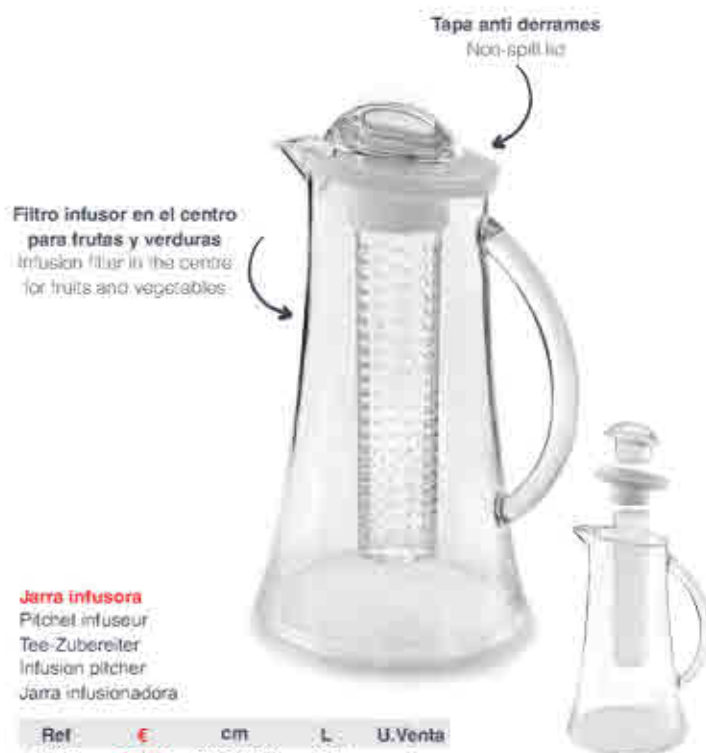

Tapa anti derrames
Non-spill lid

Filtro infusor en el centro
para frutas y verduras
Infusion filter in the centre
for fruits and vegetables

Jarra infusora
Pitchet infuseur
Tee-Zubereiter
Infusion pitcher
Jarra infusionadora

Ref.	€	cm	L	U.Venta
61954	26,56	19x16x29	2,40	1



Desenroscar la tapa girándola en sentido anti-horario.
Dévisser le couvercle dans le sens inverse des aiguilles d'une montre.
Deckel im Gegenuhrzeigersinn abschrauben.
Unscrew the lid by turning it counter-clockwise.
Desenroscar a tampa girando-a no sentido anti-horário.



Introducir la fruta, hierbas o semillas.
Mettre de fruit, des herbes ou les graines.
Geschichtenes Obst, Kräuter oder Samen hinein geben.
Introduce the fruit, herbs or seeds.
Introduzir a fruta, ervas ou sementes.



Enroscar la tapa girándola en sentido horario.
Revisser le couvercle en le faisant tourner dans le sens des aiguilles d'une montre.
Deckel im Uhrzeigersinn einschrauben.
Screw on the lid by turning it clockwise.
Enroscar a tampa girando-a no sentido horário.



Introducir el filtro dentro de la jarra y presionar la tapa hasta cerrarla.
Introduire le filtre dans le pichet et appuyer sur le couvercle jusqu'à sa fermeture.
Filter in das Gefäß einführen und Deckel zum Schließen hinunter drücken.
Put the filter in the pitcher and push the lid until it's closed.
Introduzir o filtro no interior da jarra, e pressionar a tampa até fechá-la.

JARRAS

Inox
18/10

Jarra bombada con retén
Pot à eau bombée avec retenu
Kanne mit Schnaupe
Rounded water jug with ice guard
Jarra bojuda com retentor



Ref.	€	L	U.Venta
62702	41,19	2,00	1



Jarra con tapa
Pot avec couvercle
Acrylkrug mit Deckel
Pitcher with lid
Jarra com Tampa



Ref.	€	L	U.Venta
62391	31,13	2,80	1

Inox
18/10

Jarra
Pot à eau
Wasserkanne
Water jug
Jarra



Ref.	€	Ø (cm)	L	U.Venta
62716	21,79	12x16	1,50	1
62721	23,97	12x23	2,00	1
62726	27,70	12x26,5	2,50	1



Jarra de agua
Pot à verser
Acrylkrug
Water pitcher
Jarra



Ref.	€	L	U.Venta
62392	11,72	2,00	1
62393	14,94	3,00	1

Inox
18/10

Jarra con retén
Pot à eau avec retenu
Wasserkanne mit Schnaupe
Water jug with ice guard
Jarra com retentor



Ref.	€	Ø (cm)	L	U.Venta
62715	25,32	12x16	1,50	1
62720	26,35	12x23	2,00	1
62725	29,78	12x26,5	2,50	1

VASOS TRITÁN



Fabricados en Tritán transparente libre de BPA; material muy resistente que soporta altas temperaturas.

Ligeros, versátiles y a prueba de roturas, perfectos para espacios exteriores donde la seguridad es importante.

Para servir y disfrutar todo tipo de bebidas en cualquier ocasión.

Su gran parecido visual al vidrio hace que sea sutil, elegante y de calidad, como un vaso de vidrio.

Reutilizables, irrompibles y aptos para el lavavajillas.

Fabriqués en Tritan transparent sans bisphéno A ; matériau très résistant qui supporte des températures élevées.

Légers, versatiles et à l'épreuve de la casse, ils sont parfaits pour des espaces extérieurs où la sécurité est importante.

Pour servir et déguster tout type de boissons en toute occasion.

Laur grande ressemblance visuelle avec le verre les rend subtils, élégants et de qualité, tel un authentique verre.

Réutilisable, incassable et aptes pour le lave-vaisselle.

Hergestellt aus BPA-freiem, durchsichtigem Tritan, ein hochfestes Material, das hohen Temperaturen standhält.

Leicht, vielseitig einsetzbar und bruchfest, perfekt für sicherheitsrelevante Außenbereiche.

Um beliebige Getränke zu jedem Anlass zu genießen.

Seine große Ähnlichkeit mit Glas verleiht ihm Raffinesse, Eleganz und Qualität wie ein Kristallglas.

Wiederverwendbar, unzerbrechlich und Spülmaschinen geeignet.

Manufactured in transparent BPA-free Tritan, high strength material that can withstand high temperatures.

Lightweight, versatile and break-proof, perfect for outdoor areas where safety is important.

To serve and enjoy all types of drinks for any occasion.

With its subtle, elegant and quality material, it provides a great visual resemblance to glass.

Reusable, unbreakable and dishwasher safe.

Fabricados em Tritan transparente, sem BPA. Material muito resistente, que suporta temperaturas elevadas.

Leves, versáteis e à prova de roturas, ideais para espaços exteriores onde a segurança é importante.

Para servir e desfrutar de todo o tipo de bebidas, em qualquer ocasião.

O seu grande parecido visual com o vidro converte-o num acessório.

Set 6 vasos Whisky

Set 6 verres à whisky

Set 6 Whisky-gläser

Set of 6 whisky glasses

Conjunto de 6 copos whisky



Ref	€	Ø (cm)	h (cm)	ml	U.Venta
63141	28,12	8,5	9,5	400	1

Set 6 vasos cerveza

Set 6 verres à bière

Set 6 Biergläser

Set of 6 beer glasses

Conjunto de 6 copos cerveja



Ref	€	Ø (cm)	h (cm)	ml	U.Venta
63142	49,59	8	22,5	700	1

Aptos para todos los soportes de copos LACOR

Suitable for all LACOR cup holders

Set 6 copos vino blanco

Set 6 verres à vin blanc

Set 6 Weissweingläser

Set of 6 white wine glasses

Conjunto de 6 cálices vinho branco



Ref	€	Ø (cm)	h (cm)	ml	U.Venta
63143	38,60	7	20	350	1

Aptas para todos los soportes de copas LACOR

Suitable for all LACOR cup holders

**Set 6 copas vino tinto**

Set 6 verres à vin rouge

Set 6 Rotweingläser

Set of 6 red wine glasses

Conjunto de 6 cálices vinho tinto

Ref	€	Ø (cm)	h (cm)	ml	U.Venta
63144	43,78	9,5	21	500	1

**Set 6 vasos refresco**

Set 6 verres à eau

Set 6 Gläser

Set of 6 soft drink glasses

Conjunto de 6 copos refresco

Ref	€	Ø (cm)	h (cm)	ml	U.Venta
63145	16,96	8,5	14,5	500	1

Set 6 jarra cerveza

Set 6 chopes à bière

Set 6 Bierkrüge

Set of 6 beer tankards

Conjunto de 6 jarras cerveza



Ref	€	Ø (cm)	h (cm)	ml	U.Venta
63146	52,81	8,5	14	500	1

New**Set 6 vasos agua**

Set 6 verres à eau

Set 6 Wassergläsern

Set of 6 water glasses

Conjunto de 6 copos água



Ref	€	Ø (cm)	h (cm)	ml	U.Venta
63147	41,71	8,0	10	350	1

New**Set 6 vasos Niño**

Set 6 verres enfant

Set 6 Kinderbrillen

Set of 6 child glasses

Conjunto de 6 copos criança



Ref	€	Ø (cm)	h (cm)	ml	U.venta
63148	29,78	6,5	11	300	1

Aptas para todos los soportes de copas LACOR

Suitable for all LACOR cup holders

New**Set 6 copas champán**

Set de 6 flutes à champagne au lieu de coupes

Set 6 Gläsern Champagner

Set of 6 champagne glasses

Conjunto de 6 copos champagne



Ref	€	Ø (cm)	h (cm)	ml	U.Venta
63149	43,47	4,5	22,5	150	1

▶ SOPORTE COPAS

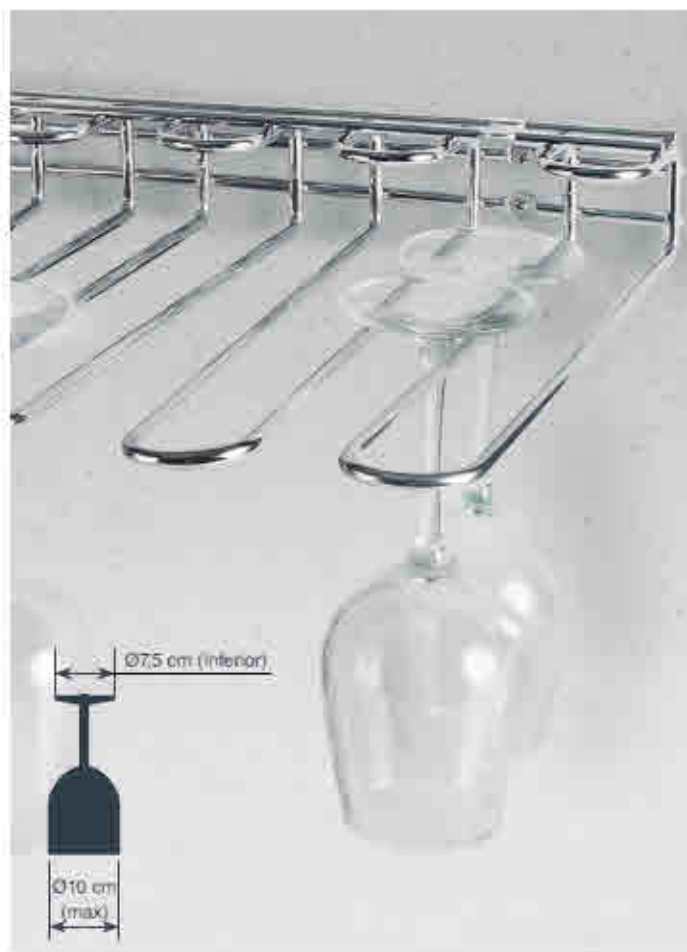

FE Cromado
Steel Chrome

Soporte que permite ahorrar espacio y almacenar las copas de forma ordenada. Se fija a la parte superior de un mueble, techo o cornisa permitiendo colocar las copas boca abajo y facilitando accesibilidad de las mismas. Desliza las copas muy fácilmente evitando que se marquen y que se rompan.

Support qui permet un gain de place et un rangement des verres à pied de façon ordonnée. Se fixe à la partie supérieure d'un meuble, d'un plafond ou d'une corniche, permettant ainsi de ranger les verres à pied vers le bas et faciliter leur accès. Fait glisser les verres très facilement, on évitant qu'ils aient des marques et qu'ils se cassent.

Platzsparender und Ordnung schaffender Gläserhalter. Wird unter Möbeln, Decken oder Simsen angebracht. Gläser werden kopfüber aufgehängt und lassen sich leicht heraus nehmen. Lässt Gläser mühelos herausgleiten, ohne Streifen oder Bruch zu verursachen.

With this rack, you can save space and store glasses in an organised way. It can be attached to the top of a piece of furniture, ceiling or moulding where the glasses are placed upside down for easy access. The glasses slide easily so they won't get scratched or broken.

Soporte que permite economizar espaço e armazenar os cálices de maneira organizada. Fixa-se à parte superior de qualquer móvel, tecto ou cornija, permitindo colocar os cálices virados para baixo, facilitando o acesso aos mesmos. Os cálices deslizam facilmente no suporte, evitando assim que se partam, ou deixar quaisquer marcas nos mesmos.

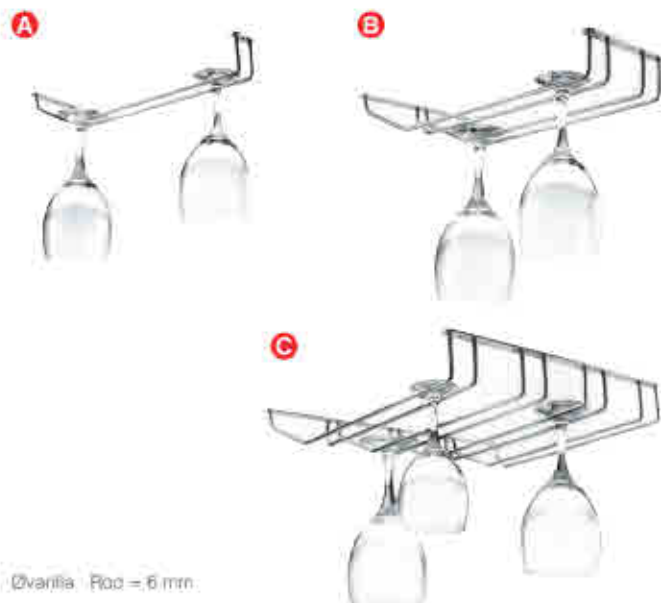

Øvarilla: Rod = 6 mm

Soporte de copas
Support à coupes
Gläserhalter
Cups stand
Suporte de tapas

	Ref	€	cm	h (cm)	U.Venta
A	62261	13,07	34x10	6	1
B	62262	19,09	34x20	6	1
C	62263	29,36	34x40	6	1

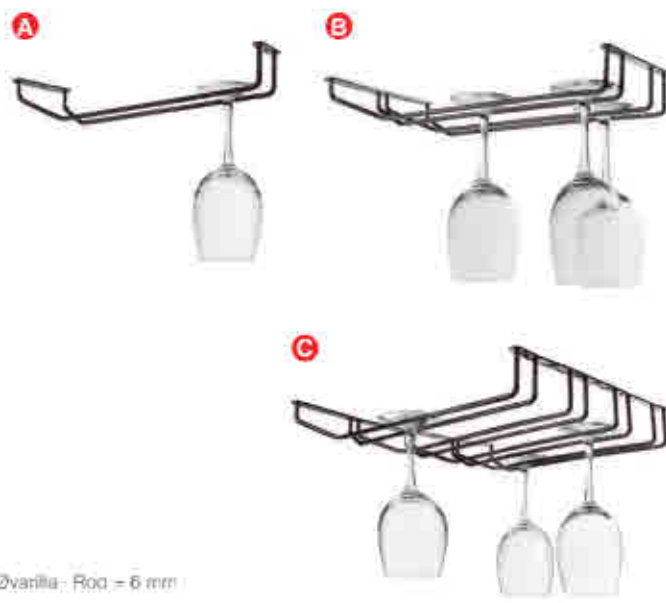

Øvarilla: Rod = 6 mm

Soporte de copas BLACK
Support à coupes
Gläserhalter
Cups stand
Suporte de tapas

	Ref	€	cm	h (cm)	U.Venta
A	62264	15,15	34x10	6	1
B	62265	23,34	34x20	6	1
C	62266	32,79	34x40	6	1

New

Capacidad
20
Copas
Wine
Glasses
Capacity



Fijado al techo
Fastened to ceiling



Fijado a la pared
Fastened to wall

Posibilidad de fijación en techo o pared
Can be fastened to a ceiling or wall

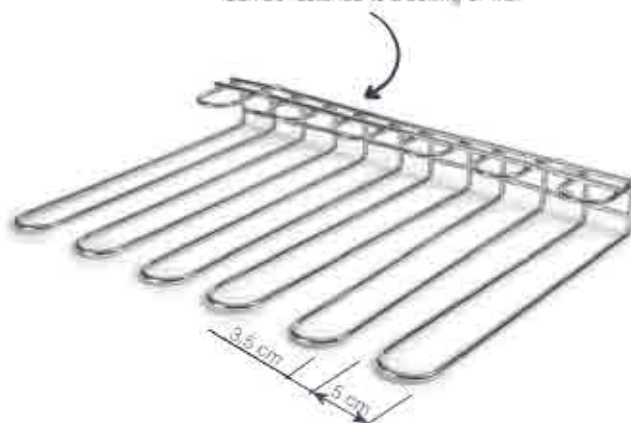

FE Cromado
Steel Chrome Øvarilla Rod = 6 mm

SopORTE de copas

Support à coupes
Gläserhalter
Cups stand
Suporte de tapas

Ref	€	cm	h (cm)	U.Venta
62268	16,19	45x32	6,0	1

SI

Silicone

Øvarilla Rod = 6 mm

Rack para copas

Support pour verres à pied
Gläserhalter
Glass rack
Rack para copas

Ref	€	cm	Copas	U.Venta
62267	15,46	31x21	6	1



Se adapta a cualquier estante, armario de cocina o comedor.
No requiere instalación, se puede mover o cambiar fácilmente de sitio.
Es estable y no raya las superficies.
Versátil, apto para todo tipo de copas. Almacena hasta seis copas.
Aprovecha al máximo el espacio de tus estantes.

Il s'adapte à tout type d'étagère, armoire ou vaisselier.
Il ne nécessite aucune installation, peut facilement être déplacé ou changé d'endroit.
Il est stable et ne raye pas les surfaces.
Versatile, il est valable pour tout type de verres à pied. Peut contenir jusqu'à six verres à pied.
Explorez au maximum l'espace de vos étagères.

Fits any shelf, kitchen or dining room cabinet.
No installation required. Can be moved easily from one place to another.
The rack is stable and does not scratch surfaces.
Versatile, suitable for all types of glasses. Stores up to six glasses.
Make the most of your shelf space.

▶ SOPORTE BOTELLAS

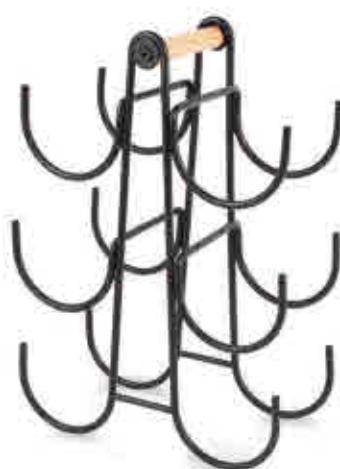

FE Madera
Steel Rubber Wood

Original botellero muy decorativo fabricado en alambre de acero, acabado en negro mate.
Resistente y duradero.

Corbeilles à casier à vin original et décorative fabriquée en fil d'acier avec une finition noir mate.
Résistante et durable.

Originelles und sehr dekoratives Weinregal aus Stahlrohr mit matschwarzer Oberfläche.
Haltbar und strapazierfähig.

Highly decorative original wine rack made of steel wire with a matte black finish.
Resistant and durable.

Original cremalheira decorativa, fabricada em arame de aço, acabamento preto mate.
Resistentes e duráveis.

Botellero

Casier à vin
Weinregal
Wine rack
Cremalheira do vinho

Ref	€	cm	h (cm)	ØVarilla (mm)	U.Venta
61141	31,13	26,6x14	37,5	4	1

▶ ACCESORIOS CÓCTEL

New



ABS

plastic



Ideal para dar un toque especial a los cócteles (Ref.: 62414).
Perfecto para organizar utensilios y accesorios de coctelería y bar como servilletas, pajitas, adornos, etc. (Ref.: 62438).
Un accesorio esencial para un servicio rápido, eficiente y ordenado.

Idéal pour apporter une touche spéciale à vos cocktails (Ref.: 62414)
Idéal pour ranger de façon organisée les ustensiles et accessoires pour cocktails et bar tels que les serviettes, les pailles, les décorations, etc. (Ref.: 62438)

Un accessoire essentiel pour un service rapide, efficace et organisé

Ideal für stimmungsvolle Cocktails (Ref.: 62414)
Idealer Organizer für Servietten, Trinkhalm, Dekoration und anderes Cocktail-Zubehör und bar. (Ref.: 62438)
Für einen schnelleren, effizienten und ordentlichen Service

Perfect for adding a special touch to your cocktails (Ref.: 62414)
Perfect for organising cocktail utensils and accessories and bar such as napkins, straws and decorations (Ref.: 62438)
A must-have accessory for a quick, efficient and tidy service

Ideal para dar um toque especial aos seus cocktails (Ref.: 62414)
Idéal para organizar utensilios e acessórios de preparação de cocktails e bar como guardanapos, palhinhas, adornos, etc. (Ref.: 62438)
Um acessório essencial para um serviço rápido, eficiente e ordenado.

Ideal para darle un toque especial a tus cócteles

Perfect for adding a special touch to your cocktails

Puede contener aproximadamente 100 servilletas de 12x12 cm
 It holds around 100 12x12 cm cocktail napkins

6 compartimentos
 6 compartments



Organizador de accesorios cóctel
 Organisateur pour accessoires de cocktail
 Organizer für Cocktailzubehör
 Cocktail accessory organiser
 Organizador de acessórios para cocktails



Ref	€	cm	h (cm)	Compartimentos	U.Venta
62438	8,09	24x14	10	6	1



Se pliega para un fácil almacenamiento
 Foldable for easy storage



Se consigue un efecto de hielo o escarcha
 Create a frosty or icy effect

3 compartimentos bien identificados
 3 well identified compartments

Almohadilla para zumo
 Pad for juice



Ribeteador de copas y vasos
 Sucreur/saleur bordeur de verres
 Umranden für Cocktailgläser
 Glass rimmer
 Decorador de copos e taças

Ref	€	cm	h (cm)	Bandejas	U.Venta
62414	11,83	20x16	7,5	3	1

Inox
18/10

Cocctelera tapón Inox

Shaker avec bouchon inox
Cocktailshaker, mit Edelstahl Verschluss
Cocktail shaker st. steel lid
Shaker tampa Inóx

Ref	€	L	U.Venta
623031	43,68	0,50	1
623041	51,88	0,75	1



Cocctelera acrílica con tapón Inox

Shaker acrylique avec bouchon inox
Cocktailshaker, Acryl, mit Verschluss
Acrylic cocktail shaker with st steel cap
Shaker acrílica com tampa en Inóx

Ref	€	Ø (cm)	h (cm)	L	U.Venta
62388	17,35	9	22,5	0,45	1



Inox
18/10

Picadora de hielo manual

Broyeur à glace manuel
Manuel Eis-Crusher
Manual ice crusher
Picadora de gelo manual

Ref	€	cm	h (cm)	U.Venta
60327	42,43	16x23	12	1



Cubitera doble pared acrílica con pinza + Tapa

Seau à glace isotherme acrylique a/pinze + Couvercle
Seltkühler, isoliert, Acryl m/Eiszange + Deckel
Acrylic double wall ice bucket with tong + Lid
Porta-cubos gelo parede dupla acrílico conpinça + Tampa

Ref	€	Ø (cm)	h (cm)	L	U.Venta
62363	22,20	20	21	3,00	1



Inox
18/10

Pinza hielo

Pince à glace
Eiszange
Ice tong
Pinça de gelo

Ref	€	L (cm)	U.Venta
62306	3,94	18,5	12



Inox
18/10

Librador

Pelle à farine
Mehlschaufel
Ice shovel
Corredor

Ref	€	ml	L (cm)	A (cm)	U.Venta
67012	15,25	60	19,0	5,0	6
67013	17,74	110	21,5	6,0	6
67014	20,96	200	24,0	7,0	6
67016	23,34	260	25,5	8,5	1
67017	25,83	360	29,0	10,0	6
67018	27,91	470	31,0	11,0	6
67019	34,76	640	35,0	12,5	6
67020	41,60	860	38,0	14,0	6



Inox

Pinza hielo LUXE

Pince à glace
Eiszange
Ice tong
Pinça de gelo

Ref	€	L (cm)	U.Venta
62337	8,51	20	12



Inox
18/10

Pinza de Hielo

Pince à glace
Eiszange
Ice tong
Pinça de gelo

Ref	€	L (cm)	U.Venta
62977	7,06	14	6



Librador

Pelle à farine
Mehlschaufel
Ice shovel
Corredor

	Ref	€	ml	Mango (cm)	U.Venta
A	67021	4,98	170	12	1
B	67022	10,17	900	12	1
C	67023	14,01	1800	14	1



Inox
18/10

Colador gusanillo

Passoire à cocktail
Cocktailsieb
Cocktail strainer
Coador batidos



Ref	€	U.Venta
62326	20,75	1

Inox
18/10

Maza negra mojito

Pilon noir mojito
Mojitostößel
Black mace mojito
Maço preto mojito



Ref	€	L (cm)	U.Venta
62278	9,86	18	1
62279	11,30	26	1



Inox
18/10

Botella sifón CO2

Bouteille siphon
Soda-Siphon
Soda maker bottle
Garrafa armadiiha



Ref	€	Ø (cm)	L	U.Venta
68601	48,14	10x39	1,00	1



Cargas para botellas sifón CO2

Cartuches CO2 pour siphon
CO2-Kapseln für Siphon
CO2 soda charges
Botijas de sifão CO2



Ref	€	Botellas	g	U.Venta
68602	7,05	10	8	1



Inox
18/10

Servidor revolver para 4 botellas

Serveur pivotant pour boissons 4 cl
Getränk-Servierer, "Revolver", mit Fues, 4 cl
Drinks revolver server w/stand 4 cl
Servidor revolver para 4 garrafas

Ref	€	L	U.Venta
62341	82,79	4 cl	1

Inox
18/10

Dosificador licor DUAL

Mesure à cocktail
Cocktailmass
Jigger
Dosificador licor



Ref	€	h (cm)	cl	U.Venta
62329	19,51	9,7	2-2,5 / 4-5	1

Inox
18/10

Dosificador licor

Mesure à cocktail
Cocktailmass
Jigger
Dosificador licor



Ref	€	cl	U.Venta
62330	17,95	2/4	1



Especial para coctelería
Especial for cocktails



Botella dosificadora cóctel

Bouteille doseuse à cocktail

Dosierflasche für Cocktails

Cocktail pourer

Garrafa doseadora pour cocktails

Ref	€	Ø (cm)	L	U.Venta
61932	12,35	9	2,00	1
61939	11,31	9	0,946	1
61935	10,89	9	0,50	1

Permite almacenar y servir cómodamente bebidas, jugos y pulpas de frutas para cócteles

Botella desmontable en 4 piezas (contenedor, tapa, cuello de botella y boquilla)

Contiene 6 boquillas de colores para identificar fácilmente las bebidas

Botella resistente y de alta calidad. Fácil de limpiar

Il permet de stocker et de servir facilement des boissons, jus et jus à pulpes de fruits pour cocktails

Botelle démontable en 4 pièces (réceptacle, couvercle, goulot et embout)

Elle contient 6 embouts de couleur afin d'identifier facilement les boissons

Botelle résistante et de haute qualité. Facile à nettoyer

Zum Aufbewahren und Ausgießen von

Getränken, Fruchtsäften und Cocktailsirup

4-teilige Flasche (Behälter, Deckel, Flaschenhals und Ausgießer)

Mit 6 farbigen Ausgießern zur Kennzeichnung des Inhalts

Aus robustem und hochwertigem Material. Leichte Reinigung

You can use it for conveniently storing and serving drinks, juices and fruit pulp for cocktails

The bottle can be taken apart into 4 pieces (container, lid, neck and mouth)

Includes 6 coloured mouths to easily identify drinks

High quality and sturdy bottle. Easy to clean

Permite armazenar e servir comodamente bebidas, sucos e polpa de frutas para cocktails

Garrafa desmontável em 4 peças (recipiente, tampa, gargalo da garrafa e boquilha)

Contém 6 boquilhas de cores para identificar facilmente as bebidas

Garrafa resistente e de alta qualidade. Fácil de limpar

Inox
18/10

Cucharilla cocktail

Cuillère cocktail

Baröffel

Cocktail spoon

Colher cocktail



Ref	€	L (cm)	U.Venta
62302	4,05	27	6

Inox
18/10

Cucharilla cocktail rizada

Cuillère cocktail cannelée

Baröffel, gewellt

Cocktail long spoon

Colher cocktail frizada



Ref	€	L (cm)	U.Venta
62352	7,16	28	6

▶ ABRE BOTELLAS PARED

New



Robusto y resistente. Fácil de montar, se fija en la pared (tornillos incluidos). Fácil apertura con una sola mano.

Robuste et résistant. Facile à installer. Il se fixe au mur (vis incluses).

Décapsulation facile d'une seule main.

Robust und widerstandsfähig. Leicht zu montieren, die Befestigung an der Wand erfolgt mit den mitgelieferten Schrauben.

Leichtes Öffnen mit nur einer Hand.

Strong and sturdy. Easy to install; attaches to the wall (included screws).

Easy to open with just one hand.

Robusto e resistente. Fácil de montar: fixa-se à parede (parafusos incluídos).

Abertura fácil, com uma só mão.

Aleación de zinc
Zinc alloy

Abrebotellas pared

Décapsuleur mural

Wandflaschenöffner

Wall mounted bottle opener

Abridor de garrafas de parede



Ref	€	cm	U.Venta
63052	3,63	6x3x8	1

SACACORCHOS · VINOTECA



Diseño inalámbrico, para una mayor movilidad.
Calidad profesional para uso en el hogar.
Funcionamiento silencioso y sin vibraciones.
Extrae los corchos sin ningún esfuerzo, con rapidez y precisión solo presionando un botón.
Mango ergonómico para un mejor agarre.
Incluye base de recarga y un práctico descapsulador con un diseño atractivo.

Conception sans fil pour une meilleure mobilité.
 Qualité professionnelle pour un usage à la maison.
 Fonctionnement silencieux et sans vibrations.
 Extraie les bouchons en liège sans aucun effort, rapidement et avec précision uniquement en appuyant sur un bouton.
 Manche ergonomique pour une meilleure prise en main.
 Inclut une base de recharge et un pratique décapsuleur doté d'un design attractif.

Kabelloses Design für mehr Beweglichkeit.
 Profi Qualität für den Hausgebrauch.
 Geräuscharm und vibrationslos.
 Zieht korken mühelos, schnell und präzise auf Knopfdruck.
 Ergonomischer Griff für besseren Halt.
 Inhalt: Ladestation mit praktischem Kapselheber in schönem Design.

Wireless design for greater mobility.
 Professional quality for home use.
 Quiet and vibration-free operation.
 Extracts corks effortlessly, quickly and precisely at the push of a button.
 Ergonomic handle for better grip.
 Includes recharging stand.
 Handy bottle opener with attractive design.

Design sem fios, para maior mobilidade.
 Qualidade profissional para uso doméstico.
 Funcionamento silencioso e sem vibrações.
 Com apenas pressionar um botão extraí as rolhas sem nenhum esforço, com rapidez e precisão.
 Mango ergonómico para melhor sujicação.
 Inclui base de recarga e um prático abridor de cápsulas com um atraente design.

Con solo presionar el botón, extraerá el corcho con suma facilidad

With simply press the button, extracts the cork with ease



Sacacorchos eléctrico con base cargador

Tire bouchon électrique a/support charge

Korkenzieher, elektrisch mit Ladestation

Electric corkscrew w/charger base

Saca-rolhas Eléctrico com Base carregador

Ref	€	W	cm	U.Venta
A 63031	35,38	1,2	Ø12x32	1
B 63054	37,97	1,8	5x5,5x25	1



A

Autonomía
Battery life

30

Botellas
Bottles



B

Autonomía
Battery life

30-40

Botellas
Bottles

Sacacorchos c/base+Descapsulador "S"

Tire bouchon+coupe capsule S

Korkenzieher+Folien cutter S

S screwpull corkscrew w/foil cutter

Saca-rolhas com base+Descapsulador "S"

Ref	€	U.Venta
63026	56,44	1



Sacacorchos negro

Tire-bouchon

Korkenzieher

Zinc alloy corkscrew

Saca-rolhas negro

Ref	€	U.Venta
63028	39,43	1





Zamak
Zinc Alloy

Sacacorchos automático profesional
Tire-bouchon automatique professionnel
Profi-Entkorker
Professional automatic corkscrew
Saca-rolhas automático profesional

	Ref	€	U.Venta
A	63010	278,88	1
B	63012	290,29	1

Zamak
Zinc Alloy

Sacacorchos doble palanca
Tire-bouchon double levier.
Korkenzieher
Double-lever corkscrew
Saca-rolhas dupla alavanca

Ref	€	U.Venta
63013	14,94	1

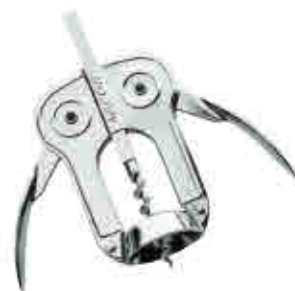

Inox

Sacacorchos camarero c/navaja Inox 18/10
Tire-bouchon limonadier inox 18/10
Kellnerkorkenzieher, Rostfrei 18/10
Waiter's corkscrew s. steel 18/10
Saca-rolhas con navalha inox 18/10

Ref	€	U.Venta
63018	4,57	6



Inox

Descapsulador ROND
Coupe capsule.
Foliencutter.
Foil cutter.
Descapsulador.

Ref	€	Ø (cm)	U.Venta
63137	4,15	6	12



Conserva el vino en perfecto estado
Keeps the wine in perfect condition

Inox

Si

ABS
plastic
Tapones
Stoppers

Bomba de 10 a 20 veces
Pump 10 to 20 times

Tapones incluidos
Stoppers included

Bomba manual vacío Inox 18/10
Pompe à vide p/bouteille de vin.
Weinpumpe, Rostfrei 18/10
St. Steel 18/10 wine vacuum sealer
Bomba manual vacío inox 18/10

Ref	€	U.Venta
63033	9,65	1
R63033	2,70	1

Tapones: Stoppers



Inox

Anilla anti-goteo
Anneau stop gouttes à vin.
Weinring Trop-Stop
Wine drip stop ring.
Anilha anti-gota.

Ref	€	Ø (cm)	U.Venta
63019	2,70	5	12



Conserva el vino en perfecto estado
Keeps the wine in perfect condition

ABS
plastic

Bomba de 10 a 20 veces
Pump 10 to 20 times

Tapones incluidos
Stoppers included

Bomba de vacío BLACK
Pompe à vide
Weinpumpe
Vacuum pump
Bomba de vacío

Ref	€	Ø (cm)	h (cm)	U.Venta
63053	9,96	4,5	14,3	1
R63053A	2,59			2

Tapones: Stoppers



Inox

Si

Silicone

Boquilla servidora + Tapón
Bec verseur + Bouchon
Ausguss-Aufsatz mit Verschluss.
Spout for wine + rubber cap
Boquilla de servir + Tampão

Ref	€	U.Venta
63022	3,74	12



Si 180°C
Silicone max

Embudo Expandible
Entonnoir extensible.
Trichter.
Foldable funnel
Funil extensível

Ref	€	Ø (cm)	H (cm)	U.Venta
68085	5,08	8	10,5	1



ABS
plastic

Zamak
Zinc Alloy

PP
Polipropileno

Inox

Tapón champán
Bouchon de Champagne
Sektflaschenverschluss
Champagne cap
Tampão champagne

	Ref	€	U.Venta
A	63020	7,57	1
B	63021	6,02	1

A



B



▶ PORTA MENÚ ACRÍLICO / ALUMINIO

New



Diseño elegante, moderno y fabricado con materiales de máxima calidad
Soporte de aluminio

2 ó 3 posibilidades de montaje; atril, pared y sobremesa
Apto para mostrar menús de tamaño A4 / A3

Hoja de información intercambiable de forma fácil, rápida y cómoda
Uso en interiores y exteriores

Stylé élégant, moderne et fabriqué avec des matériaux de première qualité
Support en aluminium

2 ou 3 possibilités de montage : debout, au mur et sur la table
Apté pour afficher des menus de format A4 / A3

Changement des documents de façon rapide, facile et pratique
Usage à l'intérieur et à l'extérieur

Hochwertige Materialien, elegant und modern geformt
Aluminiumständer

2 oder 3 Freistehend oder für Wand- oder Tischmontage
Für Speisekarten im A4 / A3-Format

Informationsblatt schnell, einfach und bequem austauschbar
Für den Außen- und Innenbereich

An elegant, modern design and manufactured with top quality materials
Aluminium stand

2 or 3 mounting possibilities; standing, wall and desktop
Suitable for displaying A4 / A3 size menus

An easy, quick and convenient exchangeable information sheet
Indoor and outdoor use

Design elegante e moderno, fabricado com materiais de primeira qualidade
Suporte de alumínio

2 ou 3 possibilidades de montagem: de pé, de parede e em cima de uma mesa
Apto para mostrar menús de tamanho A4 / A3

Hoja de informação intercambiável, de maneira fácil, rápida e cómoda
Uso em interiores e exteriores

ACRÍLICO

3 opciones de montaje - Mounting possibilities



Atril: Gracias al soporte de aluminio
Lucirn: Grâce au support en aluminium
Noscepput: Dank der Aluminiumstütze
Leclern: Thanks to the aluminum support
Atril: Graças ao suporte de alumínio



Pared: Gracias a los accesorios incluidos para anclar en la pared
Mur: Grâce aux accessoires inclus à ancrer au mur
Wand: Dank des mitgelieferten Zubehörs zur Verankerung an der Wand
Wall: Thanks to the included accessories to anchor on the wall
Parede: Graças aos acessórios incluídos para fixar na parede



Sobremesa: Gracias a los pies de apoyo incluidos
Bureau: Grâce aux pieds de support inclus
Schreibtisch: Dank der mitgelieferten Stützfüße
Table: Thanks to the support feet included
Mesa: Graças aos pés de apoio incluídos



Intercambiable de forma fácil, rápida y cómoda
Interchangeable facilement, rapidement et confortablement
Einfach, schnell und bequem austauschbar
An easy, quick and convenient exchangeable
Intercambiável com facilidade, rapidez e conforto

ALUMINIO

2 opciones de montaje - Mounting possibilities



Atril: Gracias al soporte de aluminio
Lucirn: Grâce au support en aluminium
Noscepput: Dank der Aluminiumstütze
Leclern: Thanks to the aluminum support
Atril: Graças ao suporte de alumínio



Pared: Gracias a los accesorios incluidos para anclar en la pared
Mur: Grâce aux accessoires inclus à ancrer au mur
Wand: Dank des mitgelieferten Zubehörs zur Verankerung an der Wand
Wall: Thanks to the included accessories to anchor on the wall
Parede: Graças aos acessórios incluídos para fixar na parede



Lámina de polipropileno para evitar el degradado de la hoja de información. Marco de apertura con un solo click
Lame de polypropylène pour empêcher la dégradation dans feuille d'information. Cadre d'ouverture en un clic
Polypropylen-Folie, um zu verhindern, dass sich das Informationsblatt verschlechtert. Ein-Klick-Öffnungsrahmen
Polypropylene sheet to prevent the degradation in information sheet. One-click opening frame
Folha de polipropileno para impedir a degradação da folha de informações. Moldura de abertura com um clique



Intercambiable de forma fácil, rápida y cómoda
Interchangeable facilement, rapidement et confortablement
Einfach, schnell und bequem austauschbar
An easy, quick and convenient exchangeable
Intercambiável com facilidade, rapidez e conforto

ACRÍLICO

ASA

Acrylic

Porta menú

Porte-menu
Menu-Ständer
Menu holder
Porta-menus

	Ref.	€	cm	U.Venta
A	39403	62,35	50x38 (A3)	1
B	39404	47,93	29x38 (A4)	1



ASA AL

Acrylic | Aluminium

Atril Porta menú

Pupitre Porte-menu
Menu-Ständer
Menu holder lectern
Atril Porta-menus

	Ref.	€	cm	Tamaño	U.Venta	
A	39402	124,50	34x30x1,03 m	-	1	Soporte Support
B	39423	186,96	34x30x1,07 m	A3	1	Atril A3 A3 lectern
C	39424	172,34	34x30x1,07 m	A4	1	Atril A4 A4 lectern



ALUMINIO

AL

Aluminium

Porta menú

Porte-menu
Menu-Ständer
Menu holder
Porta-menus

	Ref.	€	cm	U.Venta
A	39413	33,62	46x34 (A3)	1
B	39414	23,97	25,5x34 (A4)	1

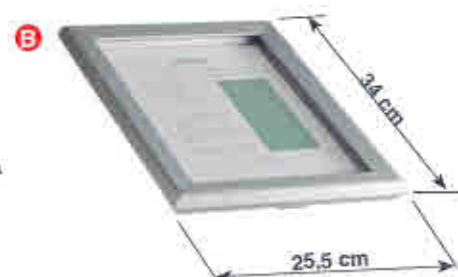

AL

Aluminium

Atril Porta menú

Pupitre Porte-menu
Menu-Ständer
Menu holder lectern
Atril Porta-menus

	Ref.	€	cm	Tamaño	U.Venta	
A	39402	124,60	34x30x1,03 m	-	1	Soporte Support
B	39433	158,22	34x30x1,07 m	A3	1	Atril A3 A3 lectern
C	39434	148,57	34x30x1,07 m	A4	1	Atril A4 A4 lectern

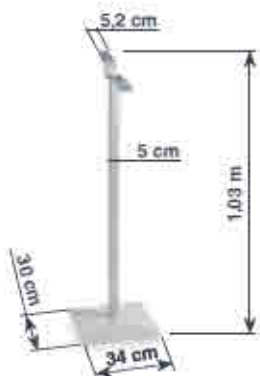

PIZARRAS



Diseño tradicional.

Ofrecen un espacio para que los establecimientos de hostelería expongan en sus locales como en la calle sus productos y menús. Puede ser personalizada tanto con tizas como con rotuladores. Limpieza muy sencilla, con un simple trapo húmedo.

Conception traditionnelle.

Offre un espace pour que les établissements d'hôtellerie qui exposent, à l'intérieur ou dans la rue, leurs produits et menus. Personnalisable aussi bien avec des craies qu'avec des feutres. Nettoyage très facile, avec un simple chiffon humide.

Traditionelles Design

Bietet eine Fläche, damit die Gastronomiebetriebe in ihren Geschäften ihre Produkte und Menüs darbieten können. Kann mit Kreide und Stiften personalisiert werden. Sehr einfache Reinigung mit einem feuchten Tuch.

Traditional design.

It offers a space for catering establishments to exhibit their products and menus within their premises as well as out on the street. It can be personalized with both chalk and marker pens. Very simple cleaning, with just a damp cloth.

Design tradicional.

Proporciona um espaço para que os estabelecimentos de hotelaria possam expor os seus produtos e menús nos locais e na rua. Personalizável com giz ou marcadores. Fácil de limpar, utilizando um pano húmido.



Pizarra de aglomerado
Chipboard slate

Madera de pino con acabado caoba
Walnut colored Pinewood



Pizarra menu

Menu ardoise
Schreibtafel Menu
Menu blackboard
Quadro de menu

Ref.	€	cm	AxB (cm)	U.Venta
39166	79,47	55x85	47x67	1
39164	115,27	65x115	55x90	1



Sólidos caballetes.
Cadena de seguridad que evita su caída.
2 caras para personalizar en tiza o rotuladores fluorescentes (Ref.: 39161). Fácil de limpiar.



Chevilles solides.
Chaine de sécurité pour éviter les chutes.
2 côtés pour personnaliser au craie ou marqueurs fluorescents (Ref.: 39161). Facile à nettoyer.



Solides Holzgestell.
Sicherheitskette gegen Umkipperfahr.
2-seitig beschreibbar mit Kreide oder fluoreszierenden Markern (Ref.: 39161). Einfach zu reinigen.

Solid frame.
Safety chain to prevent from falling.
2 sides to customize chalk or fluorescent markers (Ref.: 39161). Easy to clean.

Sólidos caballetes.
Cadena de segurança para evitar quedas.
2 lados para personalizar em giz ou marcadores fluorescentes (Ref.: 39161). Fácil de limpar.



Pizarra menu

Menu ardoise
Schreibtafel Menu
Menu blackboard
Quadro de menu

Ref.	€	cm	AxB (cm)	U.Venta
A 39162	43,78	50x80	43x73	1
B 39163	47,83	50x80	43x73	1



Diseñada para ser colocada en la pared.
Personalizable en tiza o rotuladores fluorescentes (Ref.: 39161). Fácil de limpiar.



Conception pour être mise en place sur un mur.
Personnalisable en craie ou marqueurs fluorescents (Ref.: 39161). Facile à nettoyer.



Zur Wandbefestigung.
Beschreibbar mit Kreide oder fluoreszierenden Markern (Ref.: 39161). Einfach zu reinigen.

Designed to be fixed on the wall.
Can be personalised with chalk or fluorescent markers (Ref.: 39161). Easy to clean.

Concebido para ser colocado na parede.
Personalizável em giz ou marcadores fluorescentes (Ref.: 39161). Fácil de limpar.



NO Incluidos
NOT included



Pizarra eléctrica LED

Tableau lumineux à LED
Elektronische LED Tafel
Electric blackboard LED
Ardósia LED eléctrico

**Sistema llamativo
Gran impacto visual
Limpieza muy sencilla**

Eye-catching system
Great visual impact
Cleaning very simple



Ref	€	U.Venta
A 39140	86,74	1
B 39160	119,11	1

Ref	Tensión/Voltage	Potencia/Power	Funcioned/Functions	Dimensiones/Sizes	Peso/Weight
39140	220-240 V / 50-60 Hz	2 W	38	40x60 cm	2,35 Kg
39160	220-240 V / 50-60 Hz	2 W	38	60x80 cm	4,50 Kg

Rotuladores fluorescentes 8 colores

Marqueurs fluorescents 8 couleurs
8-Farben fluoreszierenden marker
8 Fluorescent markers 8 colors
Maracadores fluorescentes 8 cores



No tóxicos, fácil de limpiar

Non toxic, easy to clean

8 colores para usar con la pizarra eléctrica Led

8 colors to use with the Led electric board

Ref	€	cm	U.Venta
39161	28,01	10	1

Visualización a doble cara

Double-sided display

New

Fijación mediante imán
Magnetic fixing



Porta menú sobremesa

Porte-menu de table
Desktop-Menu
Menu cover
Porta menu de mesa

Ref	€	cm	U.Venta
39405	8,72	11x17	1
39406	9,55	13x19	1
39407	20,65	15x21	1



Base desmontable
Removable base

Ideales para resaltar todo tipo de información (menú, especialidades del día, promociones, etc.). Desmontables para escribir fácilmente. Fácil limpieza.

Idéales pour faire ressortir tout type d'information (Menu, spécialités du jour, promotions, etc.). Démontables pour écrire confortablement. Nettoyage facile.

Idéal zur Visualisierung aller möglichen Informationen (Menü, Tagesgerichte, Angebote usw.). Demontierbar, um bequem zu schreiben. Einfache Reinigung.

Perfect for displaying all kinds of information (Fixed price menu, daily specials, promotions, etc.). Can be taken apart for easier writing. Easy to clean.

Idéal para destacar todo o tipo de información (Menú, especialidades do día, promocións, etc.). Desmontábel, para escribir comodamente. Fácil de limpar.

Soporte de madera de pino con acabado caoba

Apta para rotuladores fluorescentes (Ref.: 39161)
Walnut coloured Pinewood support
Can be used with fluorescent markers (Ref.: 39161)



Pizarra sobremesa

Ardoise de table
Tischmenü-Tafel
Tabletop Chalkboard
Quadro para mesa

Ref	€	cm	U.Venta
39415	12,97	10x15	1
39420	15,35	15x20	1
39430	18,99	20x30	1

Soporte de madera de pino con acabado caoba

Walnut coloured Pinewood support

Menú sobremesa

Menu de table
Tischmenü-Tafel
Menu Chalkboard
Menu para mesa

Ref	€	cm	U.Venta
39410	19,51	18x23	1
A 39411	6,02	-	1

Pinza Clamp



TAPA GN Y VITRINAS EXPOSITORAS BAR

New



Protección contra posibles contaminaciones
Protection against food contaminants



Perfectos para proteger y realizar la exposición de alimentos en mostradores de bares, restaurantes, pastelerías, etc.
Protección contra posibles contaminaciones de los alimentos.

Parfaits pour protéger et exposer des produits sur le comptoir des bars, restaurants, pâtisseries, etc.
Protection contre d'éventuelles contaminations des aliments.

Ideal zur Präsentation von Produkten auf den Tresen von Bars, Restaurants, Konditoreien usw.
Schützt Speisen vor Verunreinigungen.

Perfects for protecting and highlighting products displayed on counters in bars, restaurants, bakeries, etc.
Protection against potential food contaminants.

Ideais para proteger e realizar a exposição de produtos nos mostradores de bares, restaurantes, pastelarias, etc.
Proteção contra qualquer possível contaminação dos alimentos.

Tapa Roll-Top (Plegable)
Roll-Top Lid (Folding)



Apertura fácil mediante el pomo
Easy to open with the knob

PC
Polycarbonato

Tapa Expositora GN 1/1
Couvercle de Présentation GN 1/1
Rolltop-Haube
GN 1/1 Display Case Lid
Expositor com tampa GN 1/1

Ref	€	cm	GN	U.Venta
66907P	31,54	53x52,5	GN 1/1	1

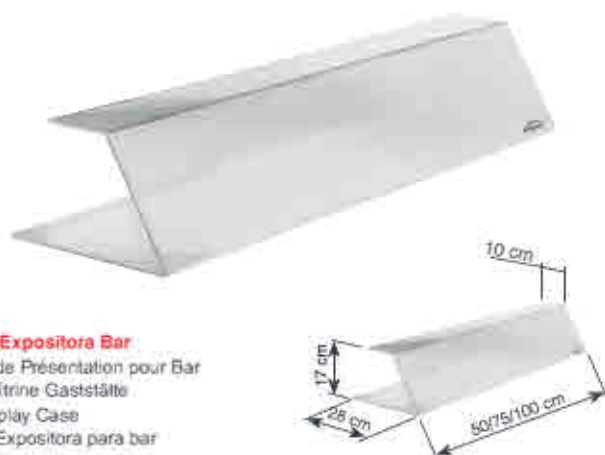

Vitrina Expositora Bar
Vitrine de Présentation pour Bar
Tisch-Vitrine Gaststätte
Bar Display Case
Vitrina Expositora para bar

Ref	€	cm	Expositor Thickness	U.Venta
39450	50,32	50x28x17	3	1
39445	74,29	75x28x17	3	1
39441	105,41	100x28x17	3	1



Vitrina Expositora Bar
Vitrine de Présentation pour Bar
Tisch-Vitrine Gaststätte
Bar Display Case
Vitrina Expositora para bar

Ref	€	cm	Expositor Thickness	U.Venta
39450	44,53	50x28x25	4	1
39455	63,70	75x28x25	4	1
39451	80,53	100x28x25	4	1

Portamenú
Portamenu

menu
#CocinaConLacor

menu



Materiales certificados

Matériaux certifiés · Zertifizierte Materialien · Authorised materials · Materiais certificados

• Simil -piel •



Poliuretano de gran calidad con una base de tejido sin tejer suave y ligeramente extensible. Aspecto de piel y tacto único. Gracias al material termo-virante, permite conseguir un atractivo efecto de estampado, consiguiendo diferentes colores según la temperatura que se le aplique.

Polyuréthane de grande qualité avec une base de tissu tissé doux et légèrement extensible. Aspect cuir et toucher unique. Grâce au matériau thermo-virant, l'on obtient un effet d'imprimé attractif, ainsi que différentes couleurs selon la température qui lui sera appliquée.

Polyurethan in hoher Qualität mit einer Basis aus weichem und leicht dehnbarem Vliesstoff. Sieht wie Leder aus und fühlt sich einzigartig an. Durch das temperatursensible Material wird ein Druckeffekt mit verschiedenen Farbtönen je nach Temperatur erzeugt.

High quality polyurethane with a base of soft and slightly extendible unwoven fabric. Leather appearance and unique feel. Thanks to its heat-burnishing material an attractive, primed effect is achieved, enabling different colours according to the temperature applied to it.

Poliuretano de grande qualidade, com uma base de tela não tecida suave e ligeiramente extensível. Aspecto de pele e tato único. O material sensível à temperatura permite conseguir um atrativo efeito de estampado, com diferentes cores segundo a temperatura aplicada.

• Telflex •



Material compuesto por un soporte celulósico recubierto con una capa vinílica de alta resistencia. Se caracteriza por su gran flexibilidad, durabilidad y resistencia a la abrasión, manchado y rayado. Acabado imitación tela.

Matériau composé d'un support cellulosique recouvert d'une couche vinylique hautement résistante. Il se caractérise par sa grande flexibilité, durabilité et résistance à l'abrasion, aux tâches et aux rayures. Finition imitation tissu.

Material auf Zellulosebasis mit einer widerstandsfähigen Vinylbeschichtung. Es zeichnet sich durch seine hohe Flexibilität, Haltbarkeit und Widerstandsfähigkeit gegen Reibung, Flecken und Kratzer aus. Oberfläche aus Stoff-Imitat.

A material comprised of a cellulose-based support covered with a high resistance vinyl layer. Characterised by its great flexibility, durability and resistance to abrasion, stains and scratches. Imitation fabric finish.

Material composto por um suporte celulósico revestido com uma camada vinílica de alta resistência. Caracteriza-se pela sua grande flexibilidade, durabilidade e resistência à abrasão, às manchas e aos riscos. Acabamento a imitar tela.

• Fibra Virgen Natural •



Fabricadas en fibra virgen natural. Material ecológico y respetuoso con el medio ambiente. Lavables, resistentes y duraderas. Tacto agradable y suave, similar a la piel. Espesor 0,55 mm

Fabriquées en fibres vierges naturelles. Matériau écologique et respectueux de l'environnement. Lavables, résistants et durables. Toucher agréable et doux, similaire au cuir. Épaisseur de 0,55 mm.

Aus naturer Faser. Umweltverträgliches Öko-Material. Waschbar, robust und langlebig. Weich und angenehm wie Leder. 0,55 mm dick.

Made of natural virgin fibre. Ecological material respectful with the environment. Washable, resistant and durable. Nice soft feel, similar to leather. Thickness 0,55 mm.

Fabricadas em fibra virgem natural. Material ecológico, respeitador do meio ambiente. Laváveis, resistentes e duráveis. Tato agradável e suave, similar ao do couro. Espessura 0,55 mm.

• PVC •



Antibacteriano
Antibacterial



Fabricados en PVC rígido transparente de alta calidad. Versátiles, económicos, resistentes y ligeros. Hojas transparentes por ambos lados. Ribeteado con cuero cosido en recto. Esquineros metálicos de color negro. Se limpian fácilmente con solución hidroalcohólica sin dañar el producto.

Fabriquées en PVC rigide transparent de grande qualité. Versatiles, économiques, résistants et légers. Feuilles transparentes des deux côtés. Finition avec du cuir cousu sur le recto. Angles métalliques de couleur noire. Nettoyage facile avec du savon, de l'alcool, du gel hydroalcoolique, etc. sans abîmer le produit.

Aus transparentem und hochwertigem Hart-PVC. Vielseitig einsetzbar, preiswert, strapazierfähig und leicht. Beidseitig transparent. Gradlinig genähter Ledersaum. Schwarze Metallecken. Zur einfachen Reinigung mit Seife, Alkohol, Gelmittel usw. geeignet.

Made of high quality transparent rigid PVC. Versatile, economical, strong and light weight. Transparent sheets on both sides. Edged with straight sewn leather. Black metal corner pieces. Easy to clean with soap, alcohol, hydrogel, etc. without damaging the product.

Fabricados em PVC rígido transparente, de alta qualidade. Versáteis, económicos, resistentes e ligeiros. Folhas transparentes de ambos os lados. Debruado a couro cosido reto. Esquinas metálicas em preto. Limpam-se facilmente com sabão, álcool, hidrogel, etc. sem danificar o produto.

NOTA - NOTE:

La limpieza deberá realizarse con un paño húmedo, pero no saturado de agua. Evite el contacto y la inmersión en agua. Evite manipularlo con las manos mojadas. NO aptos para el lavavajillas

The cleaning should be done with a damp cloth, but not saturated with water. Avoid contact and immersion in water. Avoid handling with wet hands. NOT suitable for dishwashers

Personalización

Personnalisation · Individuelle Anpassung · Customization · Personalização



Lacor pone a disposición del cliente la opción de personalizar cualquiera de las colecciones. La personalización se realiza mediante la técnica de estampado en caliente (termosellado). El logotipo deberá ser enviado vectorizado en formato Adobe Illustrator sino el vectorizado del sello se cobrará 20 €.

Se debe indicar tanto el posicionamiento como el color entre las siguientes opciones:

Lacor propose au client la possibilité de personnaliser n'importe laquelle des collections. La personnalisation est réalisée selon la technique d'estampage à chaud

(Thermoscellage). Pour ce faire, le logo devra être envoyé vectorisé en format Adobe Illustrator mais la vectorisation du timbre sera facturée 20 €. Il est nécessaire

d'indiquer aussi bien le positionnement que la couleur parmi les options suivantes:

Lacor ermöglicht dem Kunden die individuelle Anpassung jeder der Kollektionen. Die individuelle Anpassung erfolgt mittels Hotprägung. Das Logo muss vektorisiert im Adobe Illustrator-Format bereitgestellt werden, andernfalls wird das Vektorisieren des Logo mit € 20 berechnet. Aus den folgenden Optionen muss die Position und die Farbe ausgewählt werden

Lacor offers clients the option of customising any of its collections. Customisation is performed via hot stamping. The logo must be sent in vector format using Adobe Illustrator but the vectorization of the stamp will be charged 20€. Both the position and the colour of the logo must be indicated, choosing from the following options:

Lacor oferece ao cliente a opção de personalizar qualquer das coleções. A personalização é feita utilizando a técnica de estampado a quente (termoselagem), devendo o utilizador enviar o logótipo vectorizado, em formato Adobe Illustrator mas a vectorização do carimbo será cobrada 20€. Indicar tanto o posicionamento como a cor, entre as seguintes opções:

Precio · Tarif · Preisliste · Cost · Custo:

España & Portugal: 39€ / Francia: 44€ (a partir de 15 unidades)

Espagne & Portugal: 39€ / France: 44€ (a partir de 15 unités)

Spanje & Portugal: 39€ / Frankrijk: 44€ (ab 15 Einheiten)

Spain & Portugal: 39€ / France: 44€ (minimum 15 units)

Espanha & Portugal: 39€ / França: 44€ (a partir de 15 unidades)

*** Nota · Note:**

El plazo de entrega para los parquetones personalizados es de 15 días naturales

The delivery period for the personal parquetones is 15 calendar days.



Posicionamiento orientativo

Guidance position

A: Óptico · Optical

B: Centro · Centre

C: Pie centro · Bottom centre

D: Pie derecho · Bottom right

Color

Coleur · Farbe · Colour · Cor

En seco (sin color) · Dry (without colour)

Blanco · White

Negro · Black

Rojo · Red

Oro · Gold

Plata · Silver

Crema · Cream

Marrón · Brown

Azul · Blue

NOTA · NOTE:

NO se recomienda la estampación en seco en las colecciones

Dry printing is NOT recommended in the collections

LISA · VELÁZQUEZ · HELEN · TOMASSO · ANDRÉ · MATISSE · CHARLOTTE · DEGAS · CASSAT · EDGAR
SOPHIE · PAUL · MONET · GOYA · MARCEL · ANDY · PAOLO · NATURAL · KRAFT · TEX · ORGANIC

• **Made in Spain** •

Fabricados en españa · Fabriquéés en espagne

Spanischer produktion · Fabricados en espnha

Fijaciones

Fixation · Befestigung · Fixings · Fixação



FUNDAS fijas PVC

Protège-feuilles PVC · PVC hüllen · PVC covers · Capa de PVC

Fundas fijas de PVC en piel de naranja. Altamente resistentes

Protège-feuilles fixes en PVC en peau d'orange. Hautement résistantes.
Hüllen aus PVC in Orangenhaut. Sehr widerstandsfähig.
Highly resistant, fixed frosted PVC covers.
Capas fixas de PVC a imitar pele de laranja. Altamente resistentes.



SOLAPAS fijas

Rabats fixes · Feste Klappen · Fixed flaps · Abas fixas

Solapas fijas a la cubierta

Rabats fixes sur la couverture.
Am Einband befestigte Klappen.
Flaps fixed to the cover.
Abas fixas à cobertura.



ATORNILLADO interior

Vissage intérieur · Innere verschraubung · Screwed interior · Aparafusamento interior

Atornillado interior permite añadir o cambiar hojas o fundas según necesidad del cliente

Vissage intérieur pour intégrer des feuilles ou des protège-feuilles selon les besoins de l'utilisateur.
Innere Verschraubung zur Anbringung von Blättern oder Hüllen, je nach Bedarf des Benutzers.
Screwed interior to include pages or covers, according to the user's needs.
Aparafusamento interior para incluir lâminas ou capas, segundo as necessidades do utilizador.



ATORNILLADO exterior

Vissage extérieur · Äußere verschraubung · Screwed exterior · Aparafusamento exterior

Atornillado exterior permite añadir hojas o fundas según necesidad del cliente

Vissage extérieur pour intégrer des feuilles ou des protège-feuilles selon les besoins de l'utilisateur.
Äußere Verschraubung zur Anbringung von Blättern oder Hüllen, je nach Bedarf des Benutzers.
Screwed exterior to include pages or covers, according to the user's needs.
Aparafusamento exterior para incluir lâminas ou capas, segundo as necessidades do utilizador.



CORDÓN DE CUERO

Cordon en cuir · Lederband · Leather cord · Cordão de couro

Encuadernado con cordón de cuero. Permite añadir hojas o fundas según necesidad del cliente

Relié avec un cordon en cuir. Permet d'ajouter des feuilles ou des pochettes selon les besoins du client.
Ermöglicht das Hinzufügen von Blättern oder Deckblättern je nach Kundenwunsch.
Bound with leather cord. New pages or covers can be added as the customer needs.
Encadernado com cordão de couro. Permite acrescentar folhas ou capas, segundo as necessidades do cliente.

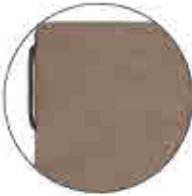

GOMA

Elastique · Gummi · Elastic band · Elástico

Encuadernado con goma. Permite añadir hojas o fundas según necesidad del cliente

Relié avec élastique. Permet d'ajouter des feuilles ou des pochettes selon les besoins du client.
Ermöglicht das Hinzufügen von Blättern oder Deckblättern je nach Kundenwunsch.
Bound with elastic band. New pages or covers can be added as the customer needs.
Encadernado com elástico. Permite acrescentar folhas ou capas, segundo as necessidades do cliente.



PINZA

Pince · Klammer · Clip · Pinça

Con pinza metálica de color plata que sujeta la hoja del menú

Doté d'une pince métallique couleur argent qui tient la feuille du menu.
Mit silberner Klammer aus Metall als Menühalter.
With a silver-coloured metal clip that holds the menu in place.
Com pinça metálica prateada para sujar a folha do menu.



IMÁN

Aimant · Magna · Magnete · Íman

Se fija mediante un robusto imán que sujeta la hoja del menú

Se fixe à l'aide d'un aimant robuste qui tient la feuille du menu.
Die Befestigung erfolgt anhand eines robusten Magneten, der das Menü-Blatt festhält.
It's attached with a powerful magnet that holds the menu sheet.
Fixa-se mediante um robusto íman, que sujeta a folha do menu.

Accesorios

Accessoires · Zubehör · Accessories · Acessórios



Set 10 fundas interiores PVC Piel de naranja

Jeu 10 feuilles intérieures PVC Peau d'Orange

10 Tlg. Innere Blätter, PVC, Orangerhaut

Set 10 interior frosted PVC pages

Set 10 lâminas interiores de PVC. Pêlo de Laranja

Ref	€	cm	U.Venta	
28191	10,27	21x29,7 (A4)	10	Ref. 28261, 28241, 28281, 28500, 28510, 28520, 28530
28192	7,99	14x26	10	Ref. 28511, 28531, 28521, 28501, 28242, 28282, 28212, 28262
28190	7,99	16x29,7	10	Ref. 28342, 28352, 28392, 28372
28193	8,09	14,8x21 (A5)	10	Ref. 28512, 28343, 28532, 28353, 28522, 28593, 28373, 28502, 28243, 28283, 28213, 28263
28194	10,27	21x29,7 (A4)	10	Ref. 28550, 28540, 28371, 28351
28203	10,27	25x32 (A4)	10	Ref. 28211, 28231, 28341, 28391, 28341, 28391
28451	10,48	23x31 (Doble/Doubla)	10	Ref. 28411, 28421, 28431, 28441
28452	9,03	17x32 (Doble/Doubla)	10	Ref. 28412, 28422, 28432, 28442
28453	6,95	16,5x23,5 (Doble/Doubla)	10	Ref. 28413, 28423, 28433, 28443



Set 12 cantoneras

Jeu 12 coins

12 Tlg. Kantenschutz

Set 12 angle irons

Set 12 cantoneiras

Ref	€	Color	U.Venta
28195	4,46	Negro · Black	1
28197	4,46	Oro · Gold	1
28198	4,46	Plata · Silver	1



Set 12 tornillos

Jeu 12 vis

12 Tlg. Schrauben

Set 12 screws

Set 12 parafusos

Ref	€	Color	U.Venta
28196	9,23	Plata · Silver	1
28199	9,55	Negro · Black	1



Set 12 cordones de cuero

Jeu 12 cordons en cuir

12 Tlg. Lederschnur

Set 12 leather laces

Set 12 cordões de couro

Ref	€	Color	m	U.Venta
28200	1,25	Marrón · Brown	1	12



Set 10 gomas

Jeu 10 élastiques

10 Tlg. Gummis

Set 10 elastic bands

Set 10 elásticos

Ref	€	Color	U.Venta	
28205	6,33	Negro · Black	1	Ref. 28411, 28421, 28431, 28441, 28412, 28422, 28432, 28442
28206	6,33	Negro · Black	1	Ref. 28413, 28423, 28433, 28443

PORTA MENÚ PVC

PVC

Plastic

New



Opción de personalizar *
Option of customising *

* Se recomienda hacerlo en los colores blanco, azul, negro, rojo y marrón.
Il est recommandé de le faire dans les couleurs blanc, bleu, noir, rouge et marron.
Es wird empfohlen, dies in den Farben Weiß, Blau, Schwarz, Rot und Braun zu tun.
It is recommended to do it in the colors white, blue, black, red and brown.
Recomanda-se fazê-lo nas cores branco, azul, preto, vermelho e marrom.

Ideal para cartas de restaurantes, bares, hoteles, etc.
Fabricados en PVC rígido transparente de alta calidad.
Versátiles y económicos. Resistentes y ligeros.
Hojas transparentes por ambos lados.
Ribeteado con cuero cosido en recto.
Esquineros metálicos de color negro.
Se limpian fácilmente con solución hidroalcohólica sin dañar el producto.

Idéal pour les cartes des restaurants, bars, hôtels, etc.
Fabriqués en PVC rigide transparent de grande qualité.
Versatiles et économiques. Résistants et légers.
Feuilles transparentes des deux côtés.
Finition avec du cuir cousu sur le recto.
Angles métalliques de couleur noire.
Nettoyage facile avec du savon, de l'alcool, du gel hydroalcoolique, etc. sans abîmer le produit.

Perfect for restaurant, bar or hotel menus.
Made of high quality transparent rigid PVC.
Versatile and economical. Strong and light weight.
Transparent sheets on both sides.
Edged with straight sewn leather.
Black metal corner pieces.
Easy to clean with soap, alcohol, hydrogel, etc. without damaging the product.

Antibacteriano · Antibacterial



Porta menú A5
Porte-menu A5
Speisekartenmappe, A5
A5 menu cover
Porta menu A5

	Ref	€	cm	Fundas	U.Venta
A	28400	7,16	A5	Individual / Individual	1
B	28401	10,79	A5	Doble / Double	1



Porta menú A4
Porte-menu A4
Speisekartenmappe, A4
A4 menu cover
Porta menu A4

	Ref	€	cm	Fundas	U.Venta
A	28402	8,72	A4	Individual / Individual	1
B	28403	14,42	A4	Doble / Double	1
C	28404	16,81	A4	Triple / Triplex	1
D	28405	18,26	A4	Cuádruple / Quadruple	1

NATURAL



Fabricado en Fibra Virgen Natural
Termosellado en color Negro

Fabriqué en fibre vierges naturelle
Thermoscollage en couleur Noir

Aus naturer Faser
Die Heißprägung ist in den Farben schwarz

Made of natural virgin fibre
Heat stamping in Black

Fabricado em fibra virgem natural
Termoselagem disponível nas cores Negro

Porta menú

Porte-menu
Speisekartenmappe
Menu cover
Porta menu

	Ref	€	cm	Fundas	U.Venta
A	28411	18,26	23x32 (A4)	4	4
B	28412	15,81	17x32	6	4
C	28413	14,94	16,5x23,5 (A5)	6	4



Sujeción con goma
Closes with elastic band

Porta menú
Mini cover

KRAFT



Fabricado en Fibra Virgen Natural
Termosellado en color Negro

Fabriqué en fibre vierges naturelle
Thermoscollage en couleur Noir

Aus naturer Faser
Die Heißprägung ist in den Farben schwarz

Made of natural virgin fibre
Heat stamping in Black

Fabricado em fibra virgem natural
Termoselagem disponível nas cores Negro

Porta menú

Porte-menu
Speisekartenmappe
Menu cover
Porta menu

	Ref	€	cm	Fundas	U.Venta
A	28421	18,26	23x32 (A4)	4	4
B	28422	16,81	17x32	6	4
C	28423	14,94	16,5x23,5 (A5)	6	4



Sujeción con goma
Closes with elastic band

TEX



Fabricado en Fibra Virgen Natural
Termosellado en color Negro

Fabriqué en fibre vierges naturelle
Thermoscollage en couleur Noir

Aus naturer Faser
Die Heißprägung ist in den Farben schwarz

Made of natural virgin fibre
Heat stamping in Black

Fabricado em fibra virgem natural
Termoselagem disponível nas cores Negro

Porta menú

Porte-menu
Speisekartenmappe
Menu cover
Porta menu

	Ref	€	cm	Fundas	U.Venta
A	28431	18,26	23x32 (A4)	4	4
B	28432	15,81	17x32	6	4
C	28433	14,94	16,5x23,5 (A5)	6	4



Sujeción con goma
Closes with elastic band

ORGANIC



Fabricado en Fibra Virgen Natural Termosellado en color Negro

Fabriqué en fibre vierges naturelle
Thermoscellage en couleur Noir

Aus naturreiner Faser
Die Heißprägung ist in den Farben schwarz

Made of natural virgin fibre
Heat stamping in Black

Fabricado em fibra virgem natural
Termoselagem disponível nas cores Negro

Porta menú

Porte-menu
Speisekartenmappe
Menu cover
Porta menu

	Ref	€	cm	Fundas	U.Venta
A	28441	18,26	23x32 (A4)	4	4
B	28442	16,81	17x32	6	4
C	28443	14,94	16,5x23,5 (A5)	6	4



Sujeción con goma
Closes with elastic band

VELÁZQUEZ



Fabricado en Simil - Piel Termosellado en color marrón

Fabriqué en cuir Simili - Cuir
Thermoscellage en couleur marron

Hergestellt aus Lederimitat
Die Heißprägung ist in den Farben braun

Manufactured in imitation leather
Heat stamping in brown

Fabricado em Simil - Pele
Termoselagem disponível nas cores castanho

Porta menú

Porte-menu
Speisekartenmappe
Menu cover
Porta menu

	Ref	€	cm	Fundas	U.Venta
A	28331	21,37	23x32 (A4)	4	4
B	28332	17,12	16x28,5	4	4
C	28333	16,29	17x23,5 (A5)	4	4

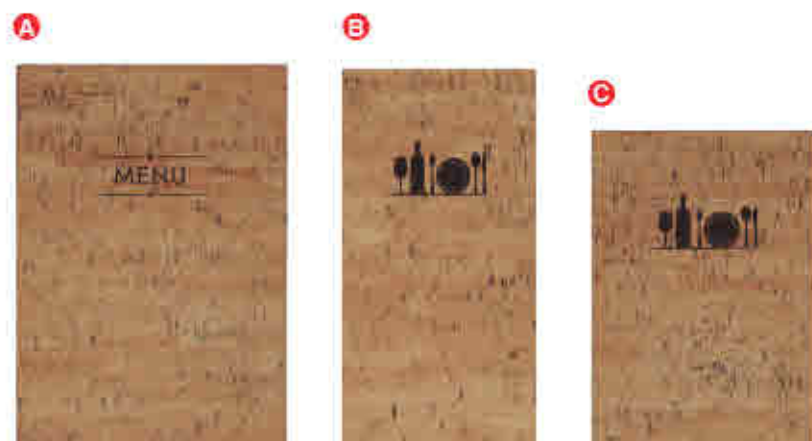

Sujeción fija
Fixed clamping

Porta comandas

Porte-commandes
Halter für Bestellungen
Order holder
Porta comandas



	Ref	€	cm	U.Venta
	28175	10,58	11x17,5	4

Porta facturas

Porte-factures
Halter für Rechnungen
Ticket holder
Porta facturas



	Ref	€	cm	U.Venta
	28176	16,81	11x18,5	4

HELEN



Fabricado en Simil - Piel
Termosellado en color marrón

Fabriqué en cuir Simil - Cuir
Thermocollage en couleur marron

Hergestellt aus Lederimita
Die Heißprägung ist in den Farben braun

Manufactured in imitation leather
Heat stamping in brown

Fabricado em Simil - Pele
Termoselagem disponível nas cores castanho

Porta menú

Porte-ménu
Speisekartenmappe
Menu cover
Porta menu

	Ref	€	cm	Fundas	U.Venta
A	28341	22,41	25,5x32 (A4)	3	4
B	28342	18,36	19,5 x 32	3	4
C	28343	17,33	19x23,5 (A5)	3	4

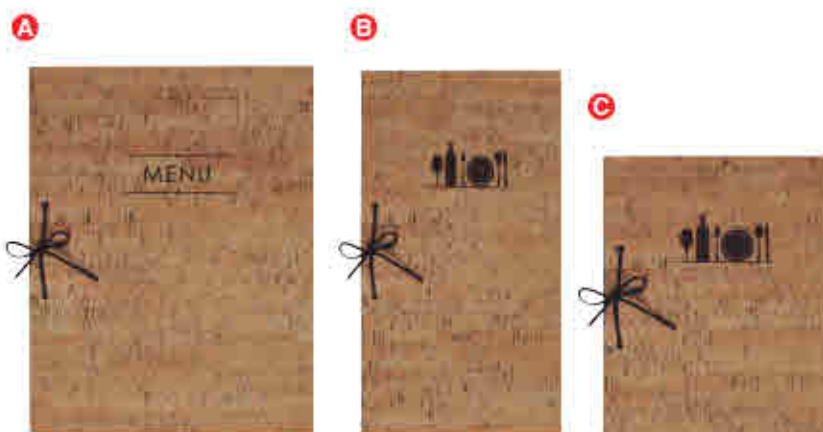

Encuadernado con cordón de cuero
Bound with leather cord

Porta menú
Menu cover

LISA



Fabricado en Simil - Piel
Termosellado en color marrón

Fabriqué en cuir Simil - Cuir
Thermocollage en couleur marron

Hergestellt aus Lederimita
Die Heißprägung ist in den Farben braun

Manufactured in imitation leather
Heat stamping in brown

Fabricado em Simil - Pele
Termoselagem disponível nas cores castanho

Porta menú

Porte-ménu
Speisekartenmappe
Menu cover
Porta menu

	Ref	€	cm	U.Venta
	28177	19,51	23 x 32 (A4)	4



Solapas fijas a la cubierta
Flaps fixed to the cover

MARISA



Fabricado en Teflex
Termosellado en color Azul

Fabriqué en cuir Teflex
Thermocollage en couleur bleu

Hergestellt aus Teflex
Die Heißprägung ist in den Farben blau

Manufactured in Teflex
Heat stamping in blue

Fabricado em Teflex
Termoselagem disponível nas cores azul

Porta menú

Porte-ménu
Speisekartenmappe
Menu cover
Porta menu

	Ref	€	cm	Fundas	U.Venta
A	28391	21,48	25,5x32 (A4)	3	4
B	28392	17,53	19,5x32	3	4
C	28393	16,39	19x23,5 (A5)	3	4

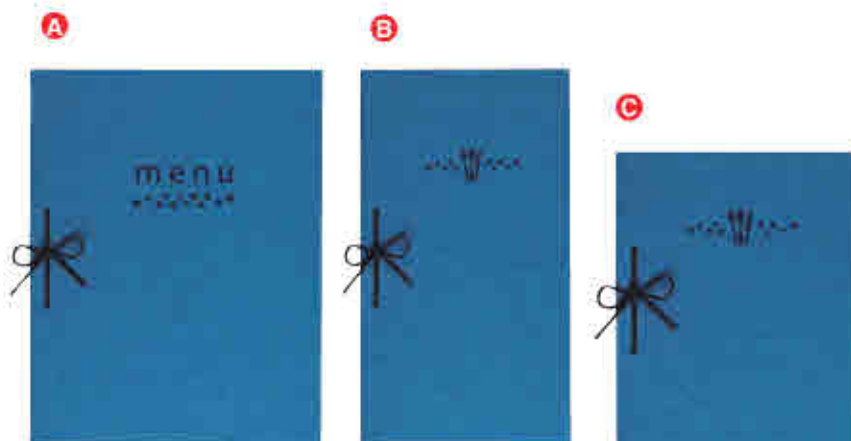

Encuadernado con cordón de cuero
Bound with leather cord

CHLOÉ



Fabricado en Telflex
 Fabricado en cuir Telflex
 Hergestellt aus Telflex
 Manufactured in Telflex
 Fabricado em Telflex



Solapa con imán
 Flap with magnet

Porta menú

Porte-menu
 Speisekartenmappe
 Menu cover
 Porta menu

Ref	€	cm	U.Venta
28395	13,80	23,5x33,5(A4)	4

SANDRO



Fabricado en Telflex
Termosellado en color Azul

Fabricado en cuir Telflex
 Thermoscellage en couleur bleu
 Hergestellt aus Telflex
 Die Heißprägung ist in den Farben blau
 Manufactured in Telflex
 Heat stamping in blue
 Fabricado em Telflex
 Termoselagem disponível nas cores azul

Porta menú

Porte-menu
 Speisekartenmappe
 Menu cover
 Porta menu

	Ref	€	cm	Fundas	U.Venta
A	28371	21,68	25,5x32 (A4)	3	4
B	28372	17,74	19,5x32	3	4
C	28373	16,60	19x23,5 (A5)	3	4

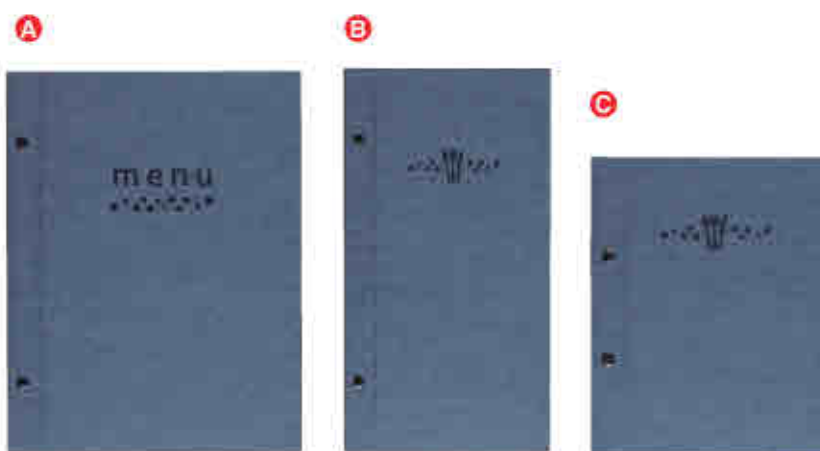

Atornillado exterior permite añadir hojas o fundas según necesidad del cliente
 Screwed exterior to include pages or covers, according to the user's needs

Porta comandas

Porte-commandes
 Halter für Bestellungen
 Order holder
 Porta comandas



Ref	€	cm	U.Venta
28375	10,17	11x17,5	4

Porta facturas

Porte-factures
 Halter für Rechnungen
 Ticket holder
 Porta facturas

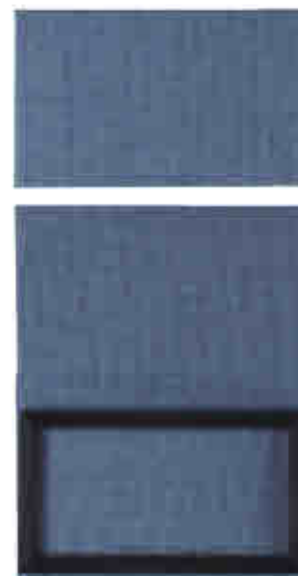

Ref	€	cm	U.Venta
28376	16,19	11x18,5	4

RENÉ

Fabricado en Simil - Piel
Termosellado en color Crema

Fabriqu  en cuir Simili - Cuir
Thermocollage en couleur Cr me

Hergestellt aus Lederimitat
Die Hei pr gung ist in den Farben cremefarben

Manufactured in imitation leather
Heat stamping in Cream

Fabricado em Simil - Pele
Termoselagem dispon vel nas cores Creme

Porta men 

Porte-menu
Speisekartenmappe
Menu cover
Porta menu

	Ref.	�	cm	Fundas	U.Venta
A	28021	21,37	23x32 (A4)	4	4
B	28022	15,29	16x28,5	4	4
C	28023	17,12	17x23,5 (A5)	4	4

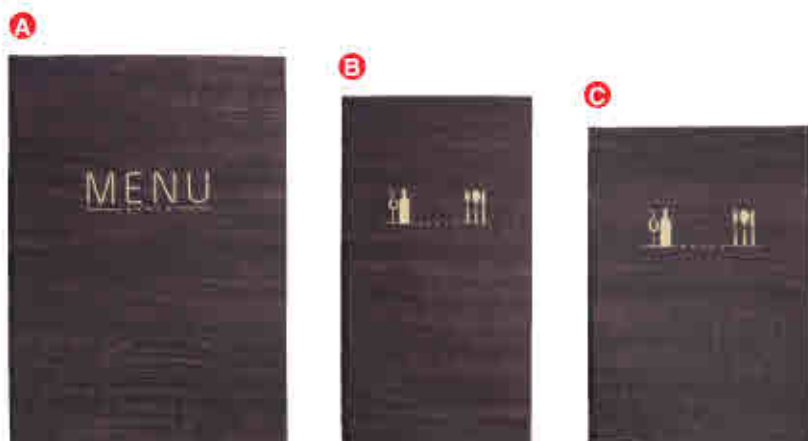

Sujeci n fija
Fixed clamping

NICOL S

Fabricado en Simil - Piel
Termosellado en color Crema

Fabriqu  en cuir Simili - Cuir
Thermocollage en couleur Cr me

Hergestellt aus Lederimitat
Die Hei pr gung ist in den Farben cremefarben

Manufactured in imitation leather
Heat stamping in Cream

Fabricado em Simil - Pele
Termoselagem dispon vel nas cores Creme

Porta men 

Porte-menu
Speisekartenmappe
Menu cover
Porta menu

	Ref.	�	cm	Fundas	U.Venta
A	28510	33,10	25,5x32 (A4)	3	4
B	28511	28,12	18x28,5	3	4
C	28512	28,74	19x23,5 (A5)	3	4

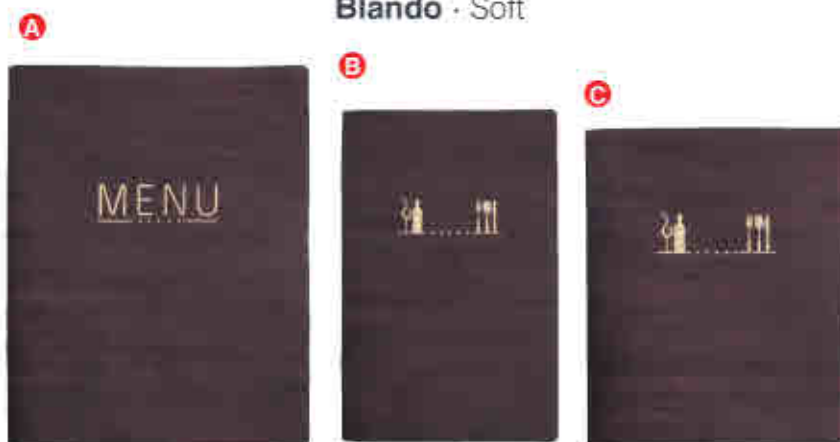

Blando - Soft

Atornillado interior permite a adir o cambiar hojas o fundas seg n necesidad del cliente
Screwed interior to include pages or covers according to the user's needs

ANDR 

Fabricado en Teflex
Termosellado en color Crema

Fabriqu  en cuir Teflex
Thermocollage en couleur Cr me

Hergestellt aus Teflex
Die Hei pr gung ist in den Farben cremefarben

Manufactured in Teflex
Heat stamping in Cream

Fabricado em Teflex
Termoselagem dispon vel nas cores Creme

Porta men 

Porte-menu
Speisekartenmappe
Menu cover
Porta menu

	Ref.	�	cm	Fundas	U.Venta
A	28031	18,57	23x32 (A4)	4	4
B	28032	14,01	16x28,5	4	4
C	28033	14,53	17x23,5 (A5)	4	4

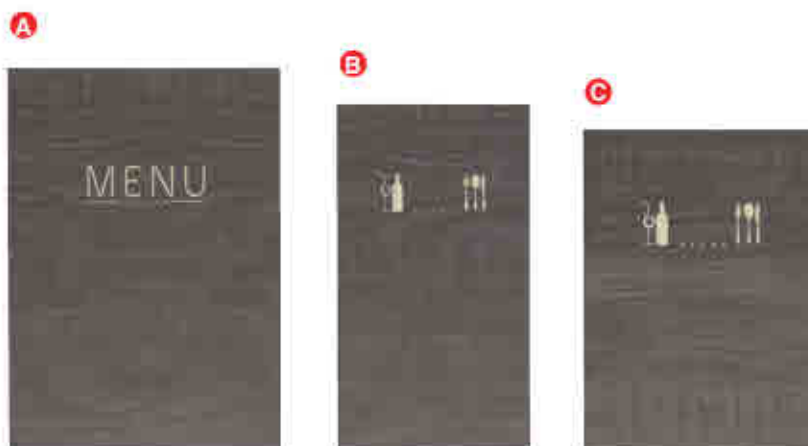

Sujeci n fija
Fixed clamping

CÉZANNE



Fabricado en Simil - Piel
Termosellado en color Crema

Fabriqué en cuir Simili - Cuir
Thermocollage en couleur Crème

Hergestellt aus Lederimitat;
Die Heißprägung ist in den Farben cremefarben

Manufactured in imitation leather
Heat stamping in Cream

Fabricado em Simil - Pele
Termoselagem disponível nas cores Creme

Porta menú

Porte-menu
Speisekartenmappe
Menu cover
Porta menu

Ref	€	cm	U.Venta
28041	17,74	23x32 (A4)	4



Solapas fijas a la cubierta
Flaps fixed to the cover

LEO



Fabricado en Simil - Piel
Termosellado en color Crema

Fabriqué en cuir Simili - Cuir
Thermocollage en couleur Crème

Hergestellt aus Lederimitat;
Die Heißprägung ist in den Farben cremefarben

Manufactured in imitation leather
Heat stamping in Cream

Fabricado em Simil - Pele
Termoselagem disponível nas cores Creme

Porta menú

Porte-menu
Speisekartenmappe
Menu cover
Porta menu

Ref	€	cm	Solapas	U.Venta
28151	25,83	25x32 (A4)	3	4



3 solapas transparentes en Renoglass 0,40 mm
3 transparent flaps in Renoglass 0.40 mm

TIZIANO



Fabricado en Simil - Piel
Termosellado en color Crema

Fabriqué en cuir Simili - Cuir
Thermocollage en couleur Crème

Hergestellt aus Lederimitat;
Die Heißprägung ist in den Farben cremefarben

Manufactured in imitation leather
Heat stamping in Cream

Fabricado em Simil - Pele
Termoselagem disponível nas cores Creme

Porta menú

Porte-menu
Speisekartenmappe
Menu cover
Porta menu

Ref	€	cm	Solapas	U.Venta
28172	23,66	17x24 (A5)	3	4



3 solapas transparentes en Renoglass 0,40 mm
3 transparent flaps in Renoglass 0.40 mm

CLAUDIO



Fabricado en Simil - Piel

Fabriqué en cuir Simili - Cuir
Hergestellt aus Lederimitat
Manufactured in imitation leather
Fabricado em: Simil - Pele



Porta menú

Porte-menu
Speisekartenmappe
Menu cover
Porta menu

Ref	€	cm	U.Venta
28321	14,94	23,5x33,5 (A4)	4

Con pinza metálica de color plata que sujeta la hoja del menú
With a silver-coloured metal clip that holds the menu in place.

MATISSE



Fabricado en Simil - Piel

Termosellado en color Negro

Fabriqué en cuir Simili - Cuir
Thermoscollage en couleur Noir

Hergestellt aus Lederimitat
Die Heißprägung ist in den Farben schwarz

Manufactured in imitation leather
Heat stamping in Black

Fabricado em: Simil - Pele
Termoselagem disponível nas cores Negro

Porta menú

Porte-menu
Speisekartenmappe
Menu cover
Porta menu

	Ref	€	cm	Fundas	U.Venta
A	28051	21,37	23x32 (A4)	4	4
B	28052	15,29	16x28,5	4	4
C	28053	17,12	17x23,5 (A5)	4	4

A



B



C



Sujeción fija
Fixed clamping

CHARLOTTE

Fabricado en Simil - Piel

Termosellado en color Negro

Fabriqué en cuir Simili - Cuir
Thermoscollage en couleur Noir

Hergestellt aus Lederimitat
Die Heißprägung ist in den Farben schwarz

Manufactured in imitation leather
Heat stamping in Black

Fabricado em: Simil - Pele
Termoselagem disponível nas cores Negro

Porta menú

Porte-menu
Speisekartenmappe
Menu cover
Porta menu

	Ref	€	cm	Fundas	U.Venta
A	28530	33,10	25,5x32 (A4)	3	4
B	28531	28,74	18x28,5	3	4
C	28532	28,12	19x23,5 (A5)	3	4



Blando · Soft

A



B



C



Atornillado interior permite añadir o cambiar hojas o fundas según necesidad del cliente
Screwed interior to include pages or covers, according to the user's needs

TOMASSO



Fabricado en Simil - Piel
Termosellado en color Negro

Fabriqué en cuir Simili - Cuir
Thermoscellage en couleur Noir

Hergestellt aus Lederimitat
Die Heißprägung ist in den Farben schwarz

Manufactured in imitation leather
Heat stamping in Black

Fabricado em Simil - Pele
Termoselagem disponível nas cores Negro

Porta menú

Porte-menu
Speisekartenmappe
Menu cover
Porta menu

	Ref	€	cm	Fundas	U.Venta
A	28351	22,52	25,5x32 (A4)	3	4
B	28352	18,57	19,5x32	3	4
C	28353	17,53	19x23,5 (A5)	3	4

A



B



C



Atornillado exterior permite añadir hojas o fundas según necesidad del cliente
Screwed exterior to include pages or covers according to the user's needs

DEGAS



Fabricado en Simil - Piel
Termosellado en color Negro

Fabriqué en cuir Simili - Cuir
Thermoscellage en couleur Noir

Hergestellt aus Lederimitat
Die Heißprägung ist in den Farben schwarz

Manufactured in imitation leather
Heat stamping in Black

Fabricado em Simil - Pele
Termoselagem disponível nas cores Negro

Porta menú

Porte-menu
Speisekartenmappe
Menu cover
Porta menu

Ref	€	cm	U.Venta
28141	19,51	23x32 (A4)	4

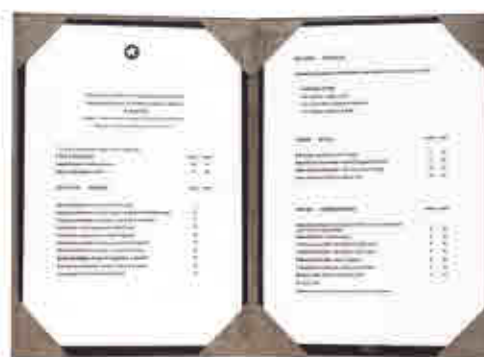

Solapas fijas a la cubierta
Flaps fixed to the cover

GOYA



Fabricado en Simil - Piel
Termosellado en color Negro

Fabriqué en cuir Simili - Cuir
Thermoscellage en couleur Noir

Hergestellt aus Lederimitat
Die Heißprägung ist in den Farben schwarz

Manufactured in imitation leather
Heat stamping in Black

Fabricado em Simil - Pele
Termoselagem disponível nas cores Negro

Porta menú

Porte-menu
Speisekartenmappe
Menu cover
Porta menu

Ref	€	cm	Solapas	U.Venta
28161	25,83	23x32 (A4)	3	4



3 solapas transparentes en Renoglass 0,40 mm
3 transparent flaps in Renoglass 0.40 mm

MARCEL



Fabricado en Simil - Piel
Termosellado en color Negro

Fabricado en cuir Simili - Cuir
Thermoscellage en couleur Noir

Hergestellt aus Lederimitat
Die Heißprägung ist in den Farben schwarz

Manufactured in imitation leather
Heat stamping in Black

Fabricado em Simil - Pele
Termoselagem disponível nas cores Negro

Porta menú

Porte-menu
Speisekartenmappe
Menu cover
Porta menu



3 solapas transparentes en Renoglass 0,40 mm
3 transparent flaps in Renoglass 0.40 mm

Ref	€	cm	Solapas	U.Venta
28182	23,66	17x24 (A5)	3	4

CASSAT



Fabricado en Teflex
Termosellado en color Negro

Fabricado en cuir Teflex
Thermoscellage en couleur Noir

Hergestellt aus Teflex
Die Heißprägung ist in den Farben schwarz

Manufactured in Teflex
Heat stamping in Black

Fabricado em Teflex
Termoselagem disponível nas cores Negro

Porta menú

Porte-menu
Speisekartenmappe
Menu cover
Porta menu

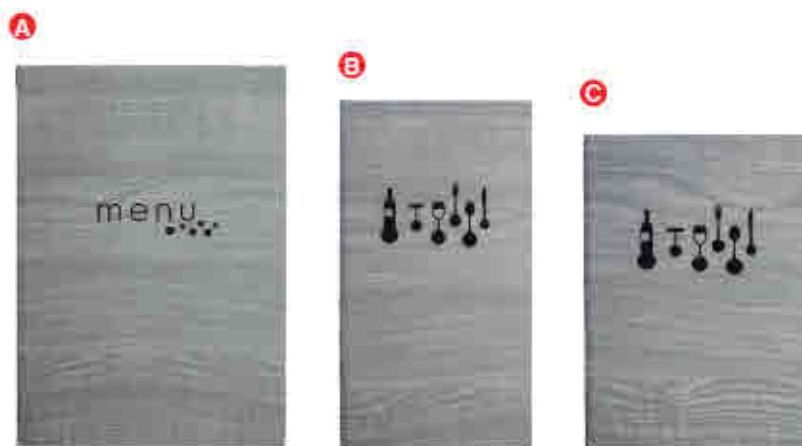

Sujeción fija
Fixed clamping

	Ref	€	cm	Fundas	U.Venta
A	28061	18,57	23x32 (A4)	4	4
B	28062	14,01	16x28,5	4	4
C	28063	14,53	17x23,5 (A5)	4	4

EDGAR



Fabricado en Teflex
Termosellado en color Negro

Fabricado en cuir Teflex
Thermoscellage en couleur Noir

Hergestellt aus Teflex
Die Heißprägung ist in den Farben schwarz

Manufactured in Teflex
Heat stamping in Black

Fabricado em Teflex
Termoselagem disponível nas cores Negro

Porta menú

Porte-menu
Speisekartenmappe
Menu cover
Porta menu



Atornillado exterior permite añadir hojas o fundas según necesidad del cliente
Screwed exterior to include pages or covers, according to the user's needs

Ref	€	cm	Fundas	U.Venta
28540	19,61	25,5x32(A4)	3	4

MAX



Fabricado en Telflex

Fabriqué en cuir Telflex
Hergestellt aus Telflex
Manufactured in Telflex
Fabricado em Telflex



Porta menú

Porte-menu
Speisekartenmappe
Menu cover
Porta menu

Ref	€	cm	U.Venta
28311	12,04	23,5x33,5 (A4)	4

Con pinza metálica de color plata que sujeta la hoja del menú

With a silver-coloured metal clip that holds the menu in place

DALÍ



Fabricado en Simil - Piel

Termosellado en color Blanco

Fabriqué en cuir Simili - Cuir
Thermoscollage en couleur Blanc

Hergestellt aus Lederimitat
Die Heißprägung ist in den Farben weiß

Manufactured in imitation leather
Heat stamping in White

Fabricado em Simil - Pele
Termoselagem disponível nas cores Branco

Porta menú

Porte-menu
Speisekartenmappe
Menu cover
Porta menu

	Ref	€	cm	Fundas	U.Venta
A	28101	19,92	23x32 (A4)	4	4
B	28102	15,25	16x28,5	4	4
C	28103	15,98	17x23,5 (A5)	4	4

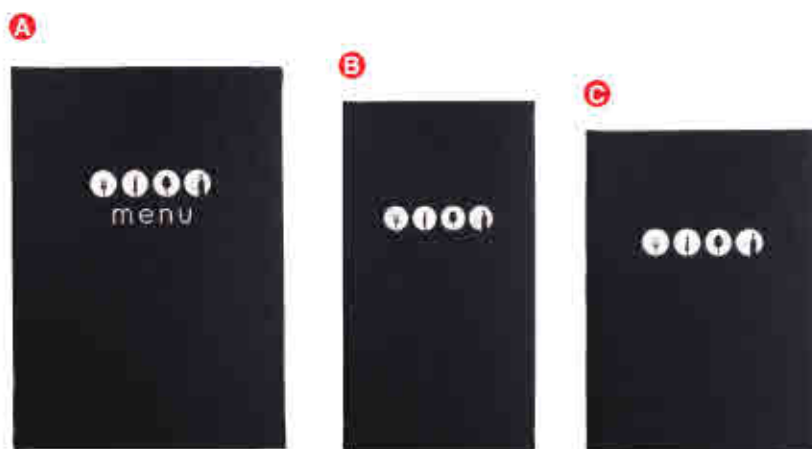

Sujeción fija
Fixed clamping

HENRY



Fabricado en Simil - Piel

Termosellado en color Blanco

Fabriqué en cuir Simili - Cuir
Thermoscollage en couleur Blanc

Hergestellt aus Lederimitat
Die Heißprägung ist in den Farben weiß

Manufactured in imitation leather
Heat stamping in White

Fabricado em Simil - Pele
Termoselagem disponível nas cores Branco

Porta menú

Porte-menu
Speisekartenmappe
Menu cover
Porta menu

	Ref	€	cm	Fundas	U.Venta
A	28520	29,57	25,5x32 (A4)	3	4
B	28521	25,73	18x28,5	3	4
C	28522	26,15	19x23,5 (A5)	3	4

Blando - Soft

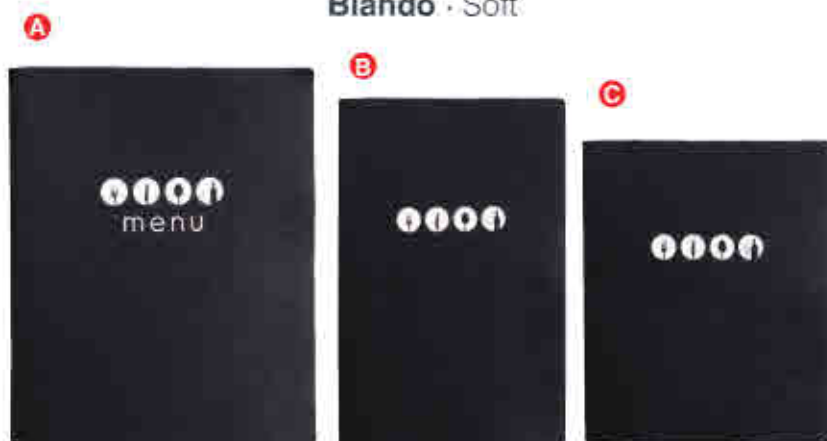

Atornillado interior permite añadir o cambiar hojas o fundas según necesidad del cliente
Screwed interior to include pages or covers, according to the user's needs

MARIE



Fabricado en Simil - Piel
Termosellado en color Blanco

Fabriqué en cuir Simili - Cuir
Thermoscellage en couleur Blanc

Hergestellt aus Lederimitat:
Die Heißprägung ist in den Farben weiß

Manufactured in imitation leather
Heat stamping in White

Fabricado em Simil - Pele
Termoselagem disponível nas cores Branco

Porta menú

Porte-ménu
Speisekartenmappe
Menu cover
Porta-menu

Ref	€	cm	U.Venta
28560	17,53	23x32 (A4)	4



Solapas fijas a la cubierta
Flaps fixed to the cover

FRIDA



Fabricado en Simil - Piel
Termosellado en color Negro

Fabriqué en cuir Simili - Cuir
Thermoscellage en couleur Noir

Hergestellt aus Lederimitat:
Die Heißprägung ist in den Farben schwarz

Manufactured in imitation leather
Heat stamping in Black

Fabricado em Simil - Pele
Termoselagem disponível nas cores Negro

Porta menú

Porte-ménu
Speisekartenmappe
Menu cover
Porta-menu

	Ref	€	cm	Fundas	U.Venta
A	28011	21,37	23x32 (A4)	4	4
B	28012	16,29	16x28,5	4	4
C	28013	17,12	17x23,5 (A5)	4	4



Sujeción fija
Fixed clamping

VERMEER



Fabricado en Simil - Piel
Termosellado en color Negro

Fabriqué en cuir Simili - Cuir
Thermoscellage en couleur Noir

Hergestellt aus Lederimitat:
Die Heißprägung ist in den Farben schwarz

Manufactured in imitation leather
Heat stamping in Black

Fabricado em Simil - Pele
Termoselagem disponível nas cores Negro

Porta menú

Porte-ménu
Speisekartenmappe
Menu cover
Porta-menu

	Ref	€	cm	Fundas	U.Venta
A	28500	33,10	25,5x32 (A4)	3	4
B	28501	28,12	18x28,5	3	4
C	28502	28,74	19x23,5 (A5)	3	4



Atornillado interior permite añadir o cambiar hojas o fundas según necesidad del cliente.
Screwed interior to include pages or covers, according to the user's needs

SOPHIE



Fabricado en Teflex Termosellado en color Negro

Fabriqué en cuir Teflex.
Thermocollage en couleur Noir

Hergestellt aus Teflex.
Die Heißprägung ist in den Farben schwarz.

Manufactured in Teflex.
Heat stamping in Black

Fabricado em Teflex.
Termoselagem disponível nas cores Negro

Porta menú

Porte-menu
Speisekartenmappe
Menu cover
Porta menu

	Ref.	€	cm	Fundas	U.Venta
A	28081	19,19	23x32 (A4)	4	4
B	28082	14,42	16x28,5	4	4
C	28083	14,94	17x23,5 (A5)	4	4

A



B



C



Sujeción fija
Fixed clamping

PAUL



Fabricado en Teflex Termosellado en color Negro

Fabriqué en cuir Teflex.
Thermocollage en couleur Noir

Hergestellt aus Teflex.
Die Heißprägung ist in den Farben schwarz.

Manufactured in Teflex.
Heat stamping in Black

Fabricado em Teflex.
Termoselagem disponível nas cores Negro

Porta menú

Porte-menu
Speisekartenmappe
Menu cover
Porta menu

	Ref.	€	cm	Fundas	U.Venta
	28550	21,17	25,5x32(A4)	3	4



Atornillado exterior permite añadir hojas o fundas según necesidad del cliente
Screwed exterior to include pages or covers according to the user's needs

ANDY



Fabricado en Simil - Piel Termosellado en color Negro

Fabriqué en cuir Simili - Cuir.
Thermocollage en couleur Noir

Hergestellt aus Lederimitat.
Die Heißprägung ist in den Farben schwarz.

Manufactured in imitation leather.
Heat stamping in Black

Fabricado em Simil - Pêda.
Termoselagem disponível nas cores Negro

Porta menú

Porte-menu
Speisekartenmappe
Menu cover
Porta menu

	Ref.	€	cm	Fundas	U.Venta
A	28271	22,83	23x32 (A4)	4	4
B	28272	18,26	15,5x28	4	4
C	28273	17,33	17x24 (A5)	4	4

A



B



C



Sujeción fija
Fixed clamping

PAOLO



Fabricado en Simil - Piel
Termosellado en color Negro

Fabriqué en cuir Simili - Cuir
Thermoscellage en couleur Noir

Hergestellt aus Lederimitat
Die Heißprägung ist in den Farben schwarz

Manufactured in imitation leather
Heat stamping in Black

Fabricado em Simil - Pele
Termoselagem disponível nas cores Negro

Porta menú

Porte-ménu
Speisekartenmappe
Menu cover
Porta-menu

	Ref.	€	cm	Fundas	U.Venta
A	28281	33,10	25,5x32 (A4)	3	4
B	28282	28,84	18x28	3	4
C	28283	28,01	19,5x23,5 (A5)	3	4

A



Blando - Soft

B



C



Atornillado interior permite añadir o cambiar hojas o fundas según necesidad del cliente
Screwed interior to include pages or covers, according to the user's needs

Porta menú
Menu cover

FRANCIS



Fabricado en Simil - Piel
Termosellado en color Blanco

Fabriqué en cuir Simili - Cuir
Thermoscellage en couleur Blanc

Hergestellt aus Lederimitat
Die Heißprägung ist in den Farben weiß

Manufactured in imitation leather
Heat stamping in White

Fabricado em Simil - Pele
Termoselagem disponível nas cores Branco

Porta menú

Porte-ménu
Speisekartenmappe
Menu cover
Porta-menu

	Ref.	€	cm	Fundas	U.Venta
A	28231	26,25	25x32 (A4)	3	4
B	28232	22,00	18x28	3	4
C	28233	21,17	19,5x23,5 (A5)	3	4

A



B



C



Atornillado interior permite añadir o cambiar hojas o fundas según necesidad del cliente
Screwed interior to include pages or covers, according to the user's needs

VICENT



Fabricado en Simil - Piel
Termosellado en color Blanco

Fabriqué en cuir Simili - Cuir
Thermoscellage en couleur Blanc

Hergestellt aus Lederimitat
Die Heißprägung ist in den Farben weiß

Manufactured in imitation leather
Heat stamping in White

Fabricado em Simil - Pele
Termoselagem disponível nas cores Branco

Porta menú

Porte-ménu
Speisekartenmappe
Menu cover
Porta-menu

	Ref.	€	cm	Fundas	U.Venta
A	28241	32,37	25,5x32 (A4)	3	4
B	28242	28,32	18x28	3	4
C	28243	27,49	19,5x23,5 (A5)	3	4

A



Blando - Soft

B



C



Atornillado interior permite añadir o cambiar hojas o fundas según necesidad del cliente
Screwed interior to include pages or covers, according to the user's needs

PABLO



Fabricado en Simil - Piel
Termosellado en color Blanco

Fabriqué en cuir Simil - Cuir
Thermocollage en couleur Blanc

Hergestellt aus Lederimitat
Die Heißprägung ist in den Farben weiß

Manufactured in imitation leather
Heat stamping in White

Fabricado em Simil - Pele
Termoselagem disponível nas cores Branco

Porta menú

Porte-menu
Speisekartenmappe
Menu cover
Porta menu

	Ref	€	cm	Fundas	U.Venta
A	28211	26,25	25x32 (A4)	3	4
B	28212	22,00	18x28	3	4
C	28213	21,17	19,5x23,5 (A5)	3	4

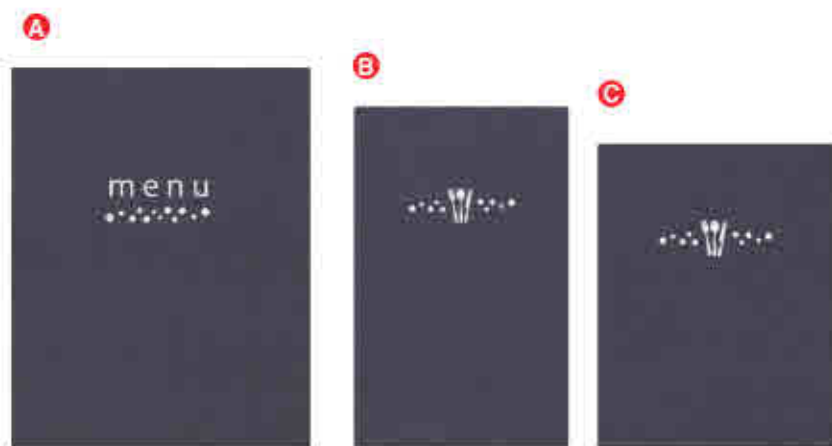

Atomillado interior permite añadir o cambiar hojas o fundas según necesidad del cliente
Screwed interior to include pages or covers, according to the user's needs

PETER

Fabricado en Simil - Piel
Termosellado en color Negro

Fabriqué en cuir Simil - Cuir
Thermocollage en couleur Noir

Hergestellt aus Lederimitat
Die Heißprägung ist in den Farben schwarz

Manufactured in imitation leather
Heat stamping in Black

Fabricado em Simil - Pele
Termoselagem disponível nas cores Negro

Porta menú

Porte-menu
Speisekartenmappe
Menu cover
Porta menu

	Ref	€	cm	Fundas	U.Venta
A	28261	32,37	25,5x32 (A4)	3	4
B	28262	28,32	18x28	3	4
C	28263	27,49	19,5x23,5 (A5)	3	4



Blando · Soft

Atomillado interior permite añadir o cambiar hojas o fundas según necesidad del cliente
Screwed interior to include pages or covers, according to the user's needs

ISABELLE

Fabricado en Simil - Piel
Termosellado en color Plata

Fabriqué en cuir Simil - Cuir
Thermocollage en couleur Argent

Hergestellt aus Lederimitat
Die Heißprägung ist in den Farben silber

Manufactured in imitation leather
Heat stamping in Silver

Fabricado em Simil - Pele
Termoselagem disponível nas cores Prata

Porta menú

Porte-menu
Speisekartenmappe
Menu cover
Porta menu

	Ref	€	cm	Fundas	U.Venta
A	28001	23,14	23x32 (A4)	6	4
B	28002	17,33	16x28,5	4	4
C	28003	18,16	17x23,5 (A5)	4	4



Sujeción fija
Fixed clamping

MILLET



Fabricado en Simil - Piel
Termosellado en color Negro

Fabricado en cuir Simil - Cuir
Thermoscellage en couleur Noir

Hergestellt aus Lederimitat
Die Heißprägung ist in den Farben schwarz

Manufactured in imitation leather
Heat stamping in Black

Fabricado em Simil - Pêla
Termoselagem disponível nas cores Negro

Porta menú

Porte-menu
Speisekartenmappe
Menu cover
Porta menu

	Ref	€	cm	Fundas	U.Venta
A	28131	19,92	23x32 (A4)	4	4
B	28132	15,25	16x28,5	4	4
C	28133	15,98	17x23,5 (A5)	4	4

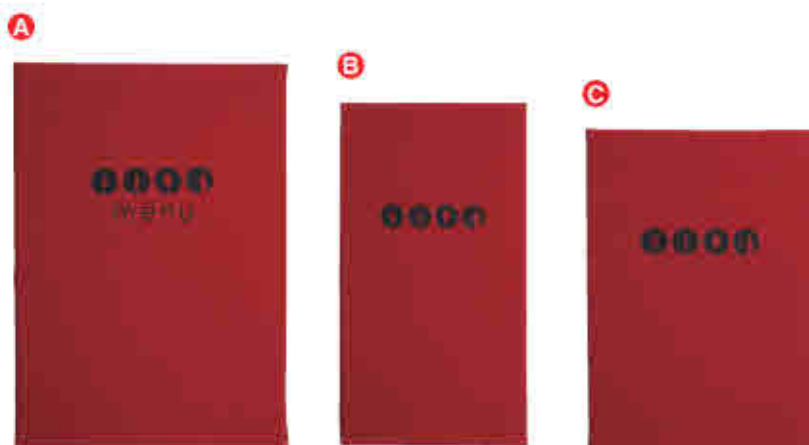

Sujeción fija
Fixed clamping

MONET



Fabricado en Teflex
Termosellado en color Negro

Fabricado en cuir Teflex
Thermoscellage en couleur Noir

Hergestellt aus Teflex
Die Heißprägung ist in den Farben schwarz

Manufactured in Teflex
Heat stamping in Black

Fabricado em Teflex
Termoselagem disponível nas cores Negro

Porta menú

Porte-menu
Speisekartenmappe
Menu cover
Porta menu

	Ref	€	cm	Fundas	U.Venta
A	28121	18,57	23x32 (A4)	4	4
B	28122	14,01	16x28,5	4	4
C	28123	14,53	17x23,5 (A5)	4	4

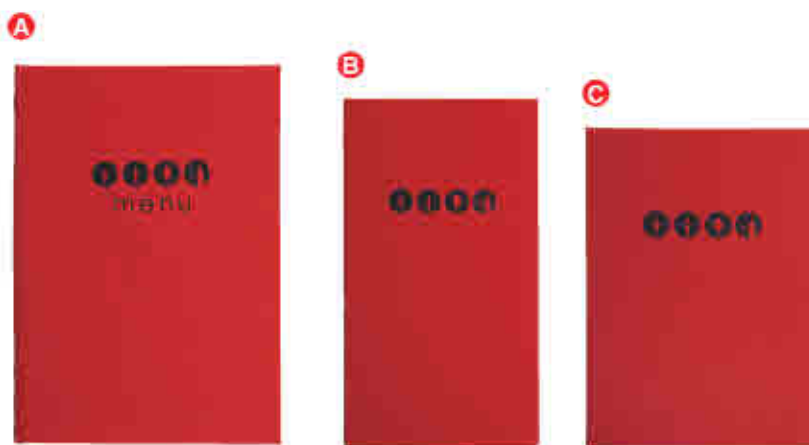

Sujeción fija
Fixed clamping

GEORGIA



Fabricado en Teflex

Fabricado en cuir Teflex
Hergestellt aus Teflex
Manufactured in Teflex
Fabricado em Teflex

Porta menú

Porte-menu
Speisekartenmappe
Menu cover
Porta menu

	Ref	€	cm	U.Venta
	28396	12,55	23,5x33,5 (A4)	4



Con pinza metálica de color plata que sujeta la hoja del menú
With a silver-coloured metal clip that holds the menu in place





CORTE CUTTING

Corte
Cutting

Cortador de bolas

Cuillère à pommes
Kugelausstecher
Fruit baller
Cortador bolas

Ref.	€	Ø (mm)	U.Venta
60366	6,54	15	1
60367	6,74	20	1
60368	6,74	25	1
60369	6,85	30	1



Cortador de bolas oval rizado

Cuillère à pommes forme oval canelée
Kugelausstecher oval, gerippt
Fruit baller oval fluted
Cortador bolas oval frizado

Ref.	€	mm	U.Venta
60372	7,37	20x32,5	1



Pelapatatas "Y"

Eplucheur "Y"
"Y" Schäler
"Y" Peeler
Pela-batatas "Y"

Ref.	€	mm	U.Venta	
60377	8,30	55x55	1	Liso - Plane
60378	8,92	55x55	1	Dentado - Serrated



Pelapatatas "P"

Eplucheur "P"
"P" Schäler
"P" Peeler
Pela-batatas "P"

Ref.	€	mm	U.Venta
60380	5,81	16x55	1



Pelador espárragos

Eplucheur à asperges
Spargelschäler
Asparagus peeler
Descascador de espárgos

Ref.	€	mm	U.Venta
60381	8,72	20x110	1



Pelador cuchilla fija

Eplucheur lame fixe
Schäler Messerfix
Fix blade peeler
Pela-batatas lámina fija

Ref.	€	mm	U.Venta
60398	4,57	15x75	1



Cuchillo vaciador

Couteau pour fruits
Frucht messer
Fruit knife
Faca para fruta

Ref.	€	mm	U.Venta
60399	5,29	20x105	1



Cuchillo para queso

Couteaux à fromage
Käsemesser
Cheese knife kitchen tool
Faca para queijo



Ref	€	cm	L (cm)	U.Venta
62675	9,96	14	28	6

Espátula lisa

Spatule lisse
Bäckschaufel
Spátula
Espátula



Ref	€	cm	L (cm)	U.Venta
62676	8,51	4,3x11	25	6

Descorazonador

Vide-pommes
Apfelentkerner
Apple corer
Descaroçador



Ref	€	cm	L (cm)	U.Venta
62686	8,72	2x2	20	6

Cortador de bolas

Cuillère à pommes
Kugelausstecher
Fruit baller
Cortador de bolas



Ref	€	cm	L (cm)	U.Venta
62683	7,78	3x1	19	6

Pelapatatas "Y"

Eplucheur "Y"
"Y" Schäler
"Y" Peeler
Descascador de batatas "Y"



Ref	€	cm	L (cm)	U.Venta
62687	10,17	5x2	18	6

Pelapatatas "P"

Eplucheur "P"
"P" Schäler
"P" Peeler
Descascador de batatas "P"



Ref	€	cm	L (cm)	U.Venta
62688	9,23	2x1	20	6

Pala pastel serrada

Palette à gâteau dentellé
Kuchenschaufel
Serrated cake shovel
Espátula de bolos c/serrilha



Ref	€	cm	L (cm)	U.Venta
62673	11,00	5,5x13	25	6

Inox
18/10

Abre ostras LUXE Inox 18/10

Couteau à huîtres LUXE en Inox 18/10
Austermesser, LUXE, Postfrei 18/10
LUXE oyster opener st. steel 18/10
Aberto-ostras Luxe Inóx 18/10



Ref	€	L (cm)	U.Venta
62684	10,79	20	1

Prensa ajos

Presse-pail
Knoblauchpresse
Garlic press
Esmaga-alhoes



Ref	€	cm	L (cm)	U.Venta
62685	21,06	3x5	18	6

Abrelatas

Ouvre-boîte
Dosenöffner
Can opener
Abre-latas



Ref	€	cm	L (cm)	U.Venta
A 62689	23,24	5x4	20	6
B 63038	19,40	5x4	17	1

▶ PELADORES

Inox



Pelador tomate dentado P
Épluche tomates à dents P
Tomatenschäler, gezackt, P
P Serrated tomato peeler
Pelador tomate dentado P



Ref	€	L (cm)	U.Venta
60351	12,55	19,5	1



Pelador tomate dentado T
Épluche tomates à dents T
Tomatenschäler, gezackt, T
T Serrated tomato peeler
Pelador tomate dentado T



Ref	€	L (cm)	U.Venta
60352	12,35	17,5	1



Descorazonador
Vide tomates
Tomatenentkerner
Tomato core remover
Descorçador



Ref	€	L (cm)	U.Venta
60353	9,34	16,5	1



Cuchillo dentado
Couteau à dents à tomates
Tomatenmesser, gezahnt
Serrated tomato knife
Faca dentada



Ref	€	L (cm)	U.Venta
60354	9,23	22	1

TPE

MangoHandle

Pelador liso P
Éplucheuse plate P
Normalen Schäler P
P peeler plain blade
Descascador liso P



Ref	€	L (cm)	U.Venta
60546	10,38	17,0	1

TPE

MangoHandle

Pelador liso Y
Éplucheuse plate Y
Normalen Schäler Y
Y peeler plain blade
Descascador liso Y



Ref	€	L (cm)	U.Venta
60547	9,44	12,5	1

Girando la cuchilla es apto para diestros y zurdos.
Turning the blade it is suitable for right- and left-handed individuals.



Pelador
Éplucheuse
Schäler
Peeler
Descascador

Ref	€	cm	U.Venta	
A 60346	10,27	5,5x12	1	Liso - Plane
B 60347	10,27	5,5x12	1	Dentado - Serrated

Cuchilla cerámica
Ceramic blades

PP

Polipropileno
Ushwasher

Mango SOFT TOUCH
SOFT TOUCH handle

Pelador cerámico Y
Éplucheuse en céramique Y
Y Schäler, Keramik
Y ceramic peeler
Descascador cerámico Y

Ref	€	cm	U.Venta
60444	3,42	8,5x16,3	6



Inox

Pelador "P" 3 cuchillas giratorias

Éplucheuse "P" 3 lames tournantes
 "P" Schäler, 3 rotierende Messer
 "P" type peeler 3 rotating blades
 Descascador "P" 3 láminas giratorias



Ref	€	L (cm)	U.Venta
50388	19,40	20	1



Inox

Pelador "Y" 3 cuchillas giratorias

Éplucheuse "Y" 3 lames tournantes
 "Y" Schäler, 3 rotierende Messer
 "Y" type peeler 3 rotating blades
 Descascador "Y" 3 láminas giratorias



Ref	€	L (cm)	U.Venta
60389	20,23	20	1

Inox

ABS
 Plastic

Pelador aguacate

Coupe avocat
 Schäler avocado
 Avocado peeler
 Descascador abacate



Ref	€	cm	U.Venta
61355	7,37	24x24	1

5 en 1

5 in 1



Inox

Hilos
 Threads
 Inox
 18/10
 TPR
 Plastic

Laminador de aguacate

Éplucheuse avocats
 Schäler avocados
 Avocado slicer
 Descascador abacater



Ref	€	cm	L (cm)	U.Venta
61353	10,17	6,2	24	1

Inox

ABS
 Plastic

Pelador de piña

Set coupe ananas
 Ananas-Schäler
 Pineapple peeler
 Pelador de ananas



Ref	€	Ø (cm)	h (cm)	U.Venta
60392	9,75	10	23	4

Inox

ABS
 Plastic

Juego cortador-pelador piña con base

Jeu couteau et éplucheur ananas
 Messer und Schäler set für ananas
 Set pineapple cutter-peeler with canister
 Jogo cortador e descascador de ananas

3 en 1

3 in 1



Ref	€	Ø (cm)	U.Venta
60393	21,17	9	1

CORTADORES ESPIRAL



Tallarines de verduras **100% naturales**
100% natural vegetable noodles



Incluye un contenedor-empujador
Includes a pusher container



Cubiertos
Cutlery

Cortador en espiral manual

Coupe en spirale manuelle
Manueller Spiralschneider
Manual spiral cutter
Cortador em espiral manual

Ref	€	Ø (cm)	h (cm)	L	U.Venta
60524	15,98	9	22	0,40	1



Corta frutas y verduras en forma de tallarines.
Ideal para calabacín, zanahoria, nabo, patata, remolacha etc.
Alimentación saludable y baja en hidratos de carbono.
Cuchillas de acero inoxidable. Se utiliza del mismo modo que un sacapuntas.

Coupe les fruits et les légumes en forme de tagliatelles.
Idéal pour les courgettes, carottes, navets, pommes de terre, betteraves, etc.
Alimentation saine et faible en hydrates de carbone.
Lames en acier inoxydable. S'utilise comme un taille-crayon.

Schneider Obst und Gemüse in Nudelform.
Ideal für Zucchini, Karotten, Rübren, Kürbisse, Risse Beete, usw.
Gesunde Ernährung, arm an Kohlehydraten.
Messer aus rostfreiem Stahl. Es wird in gleicher Weise wie ein Anspitzer verwendet.

Slice fruit and vegetables into noodle shapes.
Ideal for courgettes, carrots, turnips, potatoes, beetroot, etc.
Healthy and low carbohydrate food.
Stainless steel blades. Works just like a pencil sharpener.

Corta frutas e verduras em forma de tallarins.
Ideal para courgette, cenoura, nabo, betarra, beterraba, etc.
Alimentação saudável e baixa em hidratos de carbono.
Lâminas de aço inoxidável. Utiliza-se como um afiador de lápis.



Cortador en espiral spaguetti

Coupe en spirale
Spiralschneider
Spiral cutter
Cortador em espiral



Ref	€	Ø Int. (cm)	Cuchilla L. (cm)	U.Venta
60529	3,42	8	5,5	6



Cortador en espiral liso

Coupe en spirale lisse
Spiralschneider, glatt
Plain spiral cutter
Cortador em espiral liso



Ref	€	Ø Int. (cm)	Cuchilla L. (cm)	U.Venta
60528	3,42	8	5,5	6



Cortador en espiral dentado

Coupe en spirale dentée
Spiralschneider, gezähnt
Serrated spiral cutter
Cortador em espiral dentado



Ref	€	Ø Int. (cm)	Cuchilla L. (cm)	U.Venta
60527	3,42	8	5,5	6

CORTADORES

Pica y corta alimentos en segundos
It chops and slices foods in seconds.



3 cuchillas ultra-resistentes
3 ultra-strong blades

5 cuchillas ultra-resistentes
5 ultra-strong blades



Cortador manual SHARP

Coupe manuel
Manueller Schneider
Manual cutter
Cortador manual

	Ref	€	Ø (cm)	h (cm)	L	U.Venta
A	60299	18,62	12	11	0,5	1
B	60499	19,82	13	14	1,0	1

Cuerpo
Corp



Picadora de mecanismo manual que pica todo tipo de alimentos, como verduras, frutas, jengibre, ajo, cebolla, frutos secos e hierbas. Potentes cuchillas ultra-resistentes de acero inoxidable. Ocupa poco espacio ya que su asa-tirador se pliega sobre la tapa. Base antideslizante para facilitar la tarea y evitar desplazamientos. Pequeño, compacto, cómodo y fácil de manejar.

Hachoir à mécanisme manuel qui hache tout type d'aliments tels que les légumes, les fruits, le gingembre, l'ail, l'oignon, les fruits secs et les herbes. Puissantes lames ultra-résistantes en acier inoxydable. Prend peu de place car sa poignée se replie sur le couvercle. Base antidérapante pour faciliter le travail et éviter le déplacement de l'appareil. Petit, compact, pratique et facile à utiliser.

Handschneider zum Zerkleinern von Gemüse, Obst, Ingwer, Knoblauch, Zwiebeln, Dörrobst, Kräutern usw. Äußerst widerstandsfähigen Messern aus Edelstahl. Kurbelgriff lässt sich platzsparend in den Deckel klappen. Müheloses und sicheres Arbeiten dank rutschfester Standfläche. Klein, kompakt, und leicht zu bedienen.

This is a manual chopper that chops all foods, including vegetables, fruit, ginger, garlic, onion, dried fruit, and herbs. Powerful ultra-strong stainless steel blades. It takes up very little space as its pull handle folds onto the lid. It has a non-slip base in order to make the task easier and to prevent it from moving about. It is small, compact, convenient, and easy to use.

Picadora de mecanismo manual, que pica todo o tipo de alimentos, como verduras, frutas, gengibre, alho, cebola, frutos secos e ervas aromáticas. Potentes lâminas ultra-resistentes em aço inoxidável. A sua asa-puxador dobra-se sobre a tampa, ocupando pouco espaço. Base antiderrapante para maior facilidade de utilização. Pequena, compacta, prática e fácil de utilizar.



Alto rendimiento
Girar la manivela equivale a cortar 12 veces.
High performance
Turn of the crank is the same as cutting 12 times.

Cuchillas de acero inoxidable de alta calidad
High quality wear resistant stainless steel blades.

Cortador de verduras SAFECUT

Couper de légumes
Gemüseschneidmaschine
Vegetables cutter
Cortador de verdura

	Ref	€	cm	h (cm)	Cuchilla	U.Venta
	60298	37,66	26x13	29	3	1



2 en 1
2 in 1



Deshojador de hierbas aromáticas

Effeuilleuse à herbes aromatiques
Entblätterer für gewürzkräuter
Aromatic herb stripper
Desfolhador de ervas aromáticas



Utensilio para facilitar la separación de las hojas del tallo y cortarlas. Insertar el tallo en el agujero que mejor se adapte y deslizar la rama en dirección contraria.

Los agujeros pequeños para deshojar hierbas aromáticas como el romero, orégano, tomillo, estragón, etc.

Los agujeros más grandes para separar el tallo más duro que tienen algunas verduras de la hoja como las acelgas, espinacas, col rizada, etc.

Gracias a la parte más aguda, se pueden cortar las hojas con el mismo utensilio.

Utensil for easily separating leaves from stalks and cutting them. Put the stalk into the hole where it fits best and pull the herb in the opposite direction.

The small holes are for stripping leaves from aromatic herbs like rosemary, oregano, thyme, tarragon, etc.

The bigger holes are for separating harder stalks found in some leafy vegetables like chard, spinach, kale, etc.

With the sharp end you can use the same utensil to cut leaves.

	Ref	€	cm	U.Venta
	61359	5,60	16,5x7,5x2	1

Inox



Corta verduras manual doble cuchilla Inox

Hachoir de légumes double manuel en Inox
Doppelschneidiges Hand Wiegemesser, Rostfrei
St. steel vegetables manual double blade chopper
Corta verduras manual duplo lámina Inox

Ref.	€	cm	U.Venta
50365	14,42	17x2	10



Inox TPR PP
Cuchilla/Blade Plastic Polipropileno

Corta melones-sandías
Trancheur à melons
Wassermelonen-Schneider
Melon cutter-watermelon
Corte os melões-melancia

Ref.	€	Ø (cm)	U.Venta
50397	17,53	25,0	1



Cortador de verduras y cortador para preparar patatas Hasselback

Coupe légumes et coupe-pommes de terre pour préparer des pommes de terre Hasselback
Lässt sich für Gemüse und zum Schneiden von Hasselback-Kartoffeln verwenden
Vegetable slicer and Hasselback potato slicer
Cortador de verduras e cortador para preparar batatas estilo Hasselback



ABS Inox
18/10

Cortador de patatas HASSELBACK

Coupe-pommes de terre Hasselback
Hasselback-Kartoffelschneider
Hasselback potato slicer
Cortador de batatas Hasselback

Ref.	€	cm	h (cm)	U.Venta
59180	8,20	18x10	2,1	1

Inox TPR
Plastic

Descorazonador manual
Vide-pommes manuel
Apfelentkerner
Manual apple corer
Descorçador manual

Ref.	€	U.Venta
50350	5,64	1



Zinc Alloy

Cortahuevos doble uso DUAL
Coupe-oeuf 2 utilisations
Eierschneider, 2-teilig
2 way egg cutter
Corta-ovos duplo uso

Ref.	€	Ø (cm)	U.Venta
58305	17,43	7	1



Inox

Cortahuevos
Coupe-oeuf en inox
Eierschneider, Rostfrei
St. steel egg slicer
Corta-ovos

Ref.	€	Ø (cm)	U.Venta
58306	15,57	10	12



Inox
18/10

Cortabacalao
Couper la morue
Kabeljau-Schneider
Cul cod
Corta-bacalhau

Ref.	€	cm	U.Venta
50000	207,92	11x58,5x8	1



Inox

Cortahuevos doble uso
Coupe-oeuf 2 utilisations
Eierschneider, 2-teilig
2 way egg cutter
Corta-ovos duplo uso

Ref.	€	cm	U.Venta
58307	30,81	15x10x3,7	1



Inox
18/10



Cortaquesos cuchilla

Coupe-fromage avec lame
Käsemesser, mit Klinge
Cheese cutter with blade
Corta-queijos lâmina

Ref	€	cm	h (cm)	U.Venta
60005	24,80	27,5x21	3	1

Inox



Cortador de queso fresco

Fromage coupe fil
Draht-Käseschneider
Cheese wire cutter
Corta-queijos

Ref	€	cm	U.Venta
60004	4,15	17	12
60009	4,57	21	12

Inox



Peine cortacarne

Peigne pour coupe viande
Fleischzange
Meat tong
Pinça/pente corta-carne

Ref	€	cm	h (cm)	U.Venta
60336	16,91	11x30	6,5	6

Inox



Laminador de trufa

Coupe-Truffes
Truffeischnider
Truffe-slicer
Laminador trufa

Ref	€	L (cm)	U.Venta
61351	12,45	18	1



2 en 1
2 in 1



Inox | TPR
-plástico-

Rallador-laminador de queso

Râpe et laminoir pour le fromage
Reibe/Schneider für Käse
Cheese grater-cutter
Ralador e laminador para queijo

Ref	€	L (cm)	U.Venta
61352	14,01	23,50	1

Inox



Cortapizza

Roulette pizza
Pizzaschneider
Pizza cutter
Corta-Pizza

Ref	€	Ø (cm)	U.Venta
A 60429	4,56	10	12
B 67004	15,36	10	6
C 67028	10,59	10	1
D 67027	5,08	8	6



Rallador plano 3 usos

Râpe plat
Reibe 3 Nützlichkeit
Grater 3 uses
Rallador plano 3 usos

Ref	€	cm	U.Venta
60301	6,64	25,5x11	12



Rallador plano peso grueso

Râpe plat
Reibe, grob
Grater big hole
Rallador plano passo grosso

Ref	€	cm	U.Venta
60302	6,64	25,5x11	12



Rallador plano paso fino

Râpe plat
Reibe, fein
Grater small hole
Rallador plano passo fino

Ref	€	cm	U.Venta
60303	6,64	25,5x11	12



Extremadamente afilado
Extremely sharp



Rallador especias Mini

Râpe à épices Mini
Mini-Reibe Gewürze
Mini spices grater
Rallador especias Mini

Ref	€	cm	h (cm)	U.Venta
67032	3,11	11x7	1	6



No absorben sustancias de los alimentos
It does not absorb food stuffs



Rallador especias Mini

Râpe à épices Mini
Mini-Reibe Gewürze
Mini spices grater
Rallador especias Mini

Ref	€	cm	h (cm)	U.Venta
67182	3,84	14,5x8	1	12



No absorben sustancias de los alimentos
It does not absorb food stuffs



Rallador especias Mini

Râpe à épices Mini
Mini-Reibe Gewürze
Mini spices grater
Rallador especias Mini

Ref	€	cm	h (cm)	U.Venta
67183	3,84	11x7	1	12



Inox
18/10

Rallador de limón

Râpe muscade
Zitronenreibe
Grater semi-circular
Rallador de limão

Ref	€	cm	U.Venta
67008	5,29	23x6	12



Rallador nuez moscada Mini

Râpe à noix de muscade Mini
Mini-Musket Reibe
Mini nutmeg grater
Rallador noz-moscada Mini

Ref	€	h (cm)	U.Venta
67009	1,87	14	12



Rallador nuez moscada

Râpe à muscade
Musket Reibe
Nutmeg grater
Rallador noz-moscada

Ref	€	cm	h (cm)	U.Venta
67031	8,92	4,5x3	15	12



Rallador DUAL

Râpe
Reibe
Grater
Rallador

Ref	€	L (cm)	U.Venta
61360	8,61	31,0	5



Rallador decorador multiusos

Râpe pour décoration multi-usages
Mehrzweckreibe zum Verzieren
Multipurpose zester
Rallador decorador multiusos

Ref	€	L (cm)	U.Venta
63911	9,75	18,0	1

Rallador

Râpe
Reibe
Grater
Rallador

	Ref	€	U.Venta	
A	61341	13,38	1	Extra fino - Extra fin
B	61342	13,38	1	Fino - Thin
C	61343	13,38	1	Grueso - Thick
D	61344	13,38	1	Juliana - Julienne



Rallador largo

Râpe longue
Reibe, lang
Lengthways grater
Rallador comprimo

	Ref	€	U.Venta	
A	61345	13,38	1	Fino - Thin
B	61347	13,38	1	Medio - Medium
C	61348	13,38	1	Grueso - Thick
D	61349	13,38	1	Fino+Medio - Thin+Medium



Inox
18/10

Rallador

Râpe
Reibe
Grater
Rallador

Ref	€	h (cm)	U.Venta
60305	6,02	23	6 4 caras - 4 faces
60307	13,90	24	6 6 caras - 6 faces



Rallador LUXE

Râpe
Reibe
Grater
Rallador

Ref	€	h (cm)	U.Venta
61354	23,86	23,5	1 4 caras - 4 faces
61356	24,07	23,0	1 6 caras - 6 faces



▶ MANDOLINA VERTICAL



Corte fácil, rápido y seguro
Easy, fast and safe cutting

5 veces más rápido - 5 times quicker

Máxima seguridad - Maximum security



Su cuchilla extremadamente afilada proporciona un corte homogéneo y preciso. Corte por accionamiento vertical con una palanca de retroceso automático. Procesado de alimentos 5 veces más rápido que el trabajo manual. Pie plegable y base con 8 ventosas para mejorar la estabilidad en el uso. **SEGURO:** Protector contra cortes, no hay contacto directo con las manos durante su uso. **Dispone de un contenedor que recoge los alimentos cortados.** **Palanca con posición de bloqueo de seguridad, muy seguro para su transporte y almacenaje.** **Fácil limpieza, incluye cepillo.**

Se lame extrêmement affilée confère une coupe homogène et précise. Coupe par actionnement vertical avec un levier à retour automatique. Traitement des aliments 5 fois plus rapide que via le travail manuel. Pied pliable et base avec 8 ventouses pour améliorer la stabilité lors de l'utilisation. **ASSURANCE:** Protection anti coupures. Pas de contact direct avec les mains pendant l'utilisation. Dispose d'un conteneur qui recueille les aliments coupés. Levier avec position de blocage de sécurité, très sûr pour le transport et le rangement. Nettoyage facile. Inclut une brosse.

Scharfe Klängen sorgen für einheitliches und genaues Schneiden. Automatischer Rückstellhebel führt Schnitte senkrecht aus. Verarbeiter Lebensmittel 5-mal schneller als in Handarbeit. Klappbarer Fuß und Sockel mit 8 Saugnapfen für mehr Stabilität beim Gebrauch. **VERSICHERUNG:** Schützt gegen Schnitte, ohne direkten Handkontakt beim Gebrauch. Mit Auffangbehälter für das Schnitgut. Hebel mit verriegelter Sicherheitsstellung, für sicheren Transport und Aufbewahrung. Einfache Reinigung, Bürste imbegriffen.

It's extremely sharp blade enables even and precise cutting. Vertically operated cutting with an automatic recoil lever. Processes food 5 times quicker than manual cutting. Foldable legs and base with 8 suckers to improve stability during use. **SAFE:** Anti cut protector, no direct contact with hands during use. Includes a container that collects the chopped food. Lever with safety lock position, very safe for transport and storage. Easy cleaning, includes brush.

A sua lâmina afiada proporciona um corte homogéneo e de precisão. Corte por accionamento vertical com alavanca de retrocesso automático. Processa os alimentos 5 vezes mais rápido do que o trabalho manual. Pés dobráveis e base com 8 ventosas para maior estabilidade durante o uso. **SEGURO:** Protetor contra cortes, que evita o contacto direto com as mãos durante o corte. Recipiente para recolher os alimentos cortados. Alavanca com posição de bloqueio de segurança, ideal para o seu transporte e armazenamento. Fácil de limpar. Inclui escova de limpeza.

Multifunción: 4 tipos de corte
Multifunction: 4 types of cut

Rodajas lisas (0,5 - 8 mm)
Smooth slices (0,5 - 8 mm)



Juliana (8 mm)
Julienné (8 mm)



Cubos

Máx: 8 x 8 mm / Mín.: 0,5 x 4mm
Cubes
Max: 8 x 8 mm / Min.: 0,5 x 4mm



Juliana (4 mm)
Julienné (4 mm)



Mandolins vertical
Mandoline verticale
Mandoline, Vertikale
Vertical mandoline
Mandoline vertical

Ref	€	Corte rodaja	Corte juliana	Corte cubos	U.Venta
60460	34,65	0,5 - 8 mm	4 - 8 mm	8x8 mm _{max} / 0,5x4 mm _{min}	1

▶ MANDOLINAS



Mandolina 5 cuchillas y exprimidor

Mandoline multi-râpes et presse-fruits
Mandoline mit 5 Messern und Zitruspresse
Kitchen grater with 5 blades and squeezer
Mandolina 5 lâminas e espremedor

Ref	€	cm	U.Venta
60331	26,56	14,5x34,5	1



Mandolina corte en V + 5 Cuchillas + Exprimidor

Mandoline avec lames en "V" + 5 Lames + Presse-fruits
"V" Mandoline + 5 Messer + Zitruspresse
"V" Mandoline + 5 Blades + squeezer
Mandolina "V" + 5 Lâminas + espremedor

Ref	€	cm	U.Venta
60356	32,06	13x33,5	1



Mandolina inox con 5 cuchillas LUXE

Mandoline en inox avec 5 lames
Mandoline Rostfrei, mit 5 Messer
St. Steel mandoline with 5 blades
Mandolina inóx com 5 lâminas

Ref	€	cm	U.Venta
60332	100,74	14x42	1

Inox



Gira la rueda para seleccionar el espesor de corte o el tipo de juliana que desees obtener.

Sus cuchillas extremadamente afiladas proporcionan un corte homogéneo y preciso.

Base antideslizante y protector de dedos que evita el contacto con las cuchillas durante su uso.

Las cuchillas se extraen fácilmente para su lavado.

Pies plegables con base de silicona para mejorar la estabilidad.

Faites tourner la roue pour sélectionner l'épaisseur de la coupe ou le type de julienne que vous souhaitez obtenir.

Ses lames extrêmement aiguës confèrent une coupe homogène et précise.

Base antidérapante et protection pour les doigts qui évite le contact avec les lames pendant son utilisation.

Les lames se retirent facilement pour leur nettoyage.

Pieds réglables avec base en silicone pour améliorer la stabilité.

Schnittstärke oder Julienart nach Wunsch am Drehknopf einstellbar.

Extrem scharfe Klingen sorgen für einheitliches und genaues Schneiden.

Rutschfeste Standbeine und Fingerschutz verhindern Kontakt mit Klingen bei Gebrauch.

Zum säubern leicht entnehmbare Klingen.

Einklappbare Standbeine mit Silikoniersatz für verbesserte Standfestigkeit.

Turn the wheel to select the thickness of the slices or the type of julienne cut you wish to make.

Its extremely sharp blades make even and accurate cuts.

Non-slip base and finger guard to prevent coming in contact with the blades during usage.

The blades can be easily removed for washing.

Folding legs with a silicone base to improve stability.

Gira a roda para selecionar a espessura do corte ou o tipo de juliana pretendido.

As suas lâminas extremamente afiadas proporcionam um corte homogêneo e preciso.

Base antiderrapante e protetor de dedos, que evita o contato com as lâminas durante o uso.

As lâminas extraem-se facilmente para a sua lavagem.

Para dobráveis, com base de silicone para maior estabilidade.



Cuchillas giratorias
Rotating blades



Mandolina inox con protector

Mandoline en inoxydable avec protecteur

Mandoline, Edelstahl, mit Resthalter

St. steel mandoline slicer w/protector

Mandolina inoxidável com protector

Ref	€	cm	U.Venta
60357	109,04	12,5x50	1

▶ MÁQUINAS DE CORTE



Aumenta la productividad disminuyendo el tiempo de trabajo frente a sistemas convencionales.

Gama de Corte Profesional con 4 modelos de corte manual. Con un diseño robusto y ergonómico, gracias a sus cuchillas de acero inoxidable (resistentes a la corrosión), aseguran un corte uniforme y de gran calidad. Ideales para cualquier cocina industrial, su fácil manejo permite obtener un óptimo rendimiento con el mínimo esfuerzo.

Augmente la productivité et diminuez le temps de travail par rapport aux systèmes conventionnels.

Gamme de Coupe Professionnelle avec 4 modèles de coupe manuelle. Avec une conception robuste et ergonomique, notamment grâce aux lames en acier inoxydable (résistantes à la corrosion), ils garantissent une coupe uniforme et de grande qualité. Ils s'adaptent parfaitement aux différents types de cuisine industrielle et la facilité de manipulation permet d'obtenir un rendement optimal avec le moindre effort.

Erhöhe im Vergleich zu konventionellen Systemen die Produktivität bei geringerer Arbeitszeit!

Prof. Alleschneidern mit 4 Modelle im Bereich Handschneidemaschinen. Robustes und ergonomisches Design, seine Edelstahlklingen (rostresistent) garantieren einen gleichmäßigen, präzisen Schnitt. Ideal für jede Industrieküche, da die einfache Bedienung optimale Leistung bei minimalem Aufwand erlaubt.

Increases productivity by reducing working time when compared to conventional systems.

Range of Professional Cutting Utensils with 4 new manual cutting models. With a robust and ergonomic design, its stainless steel (corrosion resistant) blades ensure a smooth and high quality cut. Ideal for any Industrial kitchen, their ease of use enables optimum performance with minimum effort.

Aumenta a produtividade reduzindo o tempo de trabalho em comparação com os sistemas convencionais.

Gama de Corte Profissional com 4 novos modelos de corte manual. Com um design robusto e ergonómico, graças às suas lâminas de aço inoxidável (resistentes à corrosão), asseguram um corte uniforme e de grande qualidade. Ideais para qualquer cozinha industrial, o seu fácil manejo permite obter um ótimo rendimento com o mínimo esforço.



10 cuchillas de corte
10 cutting blades



Asa de gran robustez para transportar la máquina.
10 cuchillas para un perfecto laminado.
Bandeja recoge alimentos.
Ventosas de sujeción.

Asse extrêmement robuste pour transporter la machine.
10 lames pour une plastification parfaite.
Plateau destiné au ramassage des aliments.
Préhension ventouses.

Extrem robustes Tragegriff
10 Klingen für eine perfekt Schnittstärke
Servierplatte
Griff Saugnapfe.

Robust handle for carrying the machine.
10 blades for a perfect lamination.
Food collection tray.
Gripping suckers.

Asa de grande robustez para transportar a máquina.
10 lâminas para uma laminação perfeita.
Bandeja recolhadora de alimentos.
Ventosas de sujeción.

Máquina corta tomates
Machine pour couper tomates
Tomatenschneider
Tomato cutter machine
Máquina cortador tomate

Ref.	€	Espesor (mm) / Nº rodajas	cm	Kg	U.Venta
60510	211,34	5,5 / 9 rodajas	43x20x21	5,20	1



2 en 1
2 in 1



Colóquelo donde quiera (mesa-pared-tabla).
4 cuchillas diferentes; 7x7 mm / 10x10 mm / 15x15 mm / 8 gajos.
Estructura desmontable y fácil limpieza.

Placir où (table-mur-table).
4 lames différentes; 7x7 mm / 10x10 mm / 15x15 mm / 8 coins.
Structure démontable et facile à nettoyer.

Placieren Sie sie ob immer (Tisch-Wand-Brett).
4 verschiedenen Klingen; 7x7 mm / 10x10 mm / 15x15 mm / 8 Schieber.
Leicht zu reinigende auseinandermontierbare Struktur.

Place it wherever (table-wall-board).
4 different blades; 7x7 mm / 10x10 mm / 15x15 mm / 8 wedges.
Collapsible structure and easy cleaning.

Coloque-o onde quier (tabela-pared-tabela).
4 lâminas diferentes; 7x7 mm / 10x10 mm / 15x15 mm / 8 curvas.
Estrutura desmontável e de fácil limpeza.

AL
Aluminium

Máquina corta patatas y gajos
Machine pour chips trancheuse et wedger
Pommes Frites und Wedger-Schneider
Potato chips slicer and wedger machine
Máquina cortador batatas e gomos

Ref.	€	Dados (mm)	Gajos	cm	Kg	U.Venta
60513	192,15	7x7 / 10x10 / 15x15	8	26x26x42	8,0	1



Corta patatas chip 3 cortadores

Coupe-Frites 3 Lames

Pommes Frites-Schneider, 3 Klingen

Potato Chips Cutter 3 Blades

Corta-batatas chip 3 cortadores

Ref.	€	Dados (mm)	U.Venta
60343	181.15	6x6 / 8x8 / 10x10	1



Colóquelo donde quiera (mesa-encimera-tabla)
3 cuchillas diferentes; 6x6 mm / 8x8 mm / 10x10 mm
Estructura desmontable y fácil limpieza

Place it (table-worktop-table)
 3 lames diferentes; 6x6 mm / 8x8 mm / 10x10 mm
 Structure démontable et facile à nettoyer

Placieren Sie sie ob (Tisch-Wand-Brett)
 3 verschiedenen Klingen; 6x6 mm / 8x8 mm / 10x10 mm
 Leicht zu reinigende auseinandermontierbare Struktur

Place it wherever (table-worktop-board)
 3 different blades; 6x6 mm / 8x8 mm / 10x10 mm
 Collapsible structure and easy cleaning

Coloque-o onde quer (tabela-bancada-tabela)
 3 lâminas diferentes; 6x6 mm / 8x8 mm / 10x10 mm
 Estrutura desmontável e de fácil limpeza



AL

Aluminium

Máquina corta patatas vertical

Machine pour chips trancheuse vertical

Pommes Frites-Schneider vertikal

Vertical chips slicer machine

Máquina cortador batatas vertical

Ref.	€	Dados (mm)	cm	h (cm)	Kg	U.Venta
60511	152.20	10x10	20x20	48	6,0	1



Amortiguadores para evitar golpes al cortar los alimentos.
Asa empujador robusta para un mejor manejo.
Patas de goma para una mejor sujeción.

Amortisseurs pour éviter les coups pendant la coupe des aliments
 Poignée pousseur robuste pour une meilleure manipulation
 Pieds en caoutchouc pour une saisie optimale



Stoßdämpfer für geschmeidigeres Schneiden
 Robuster Rasthalter für einfache Bedienung
 Antirutsch-Gummifüße



Shock absorbers to prevent any knocks when cutting food
 Robust pusher handle for better handling
 Rubber feet for better grip

Amortecedores para evitar golpes ao cortar os alimentos
 Asa de empurrar robusta para um melhor manejo
 Patas de borracha para melhor sujeição

PROTECCIÓN

Composición / Composition:
62% Poliétileno / 62% Polyethylene
24% Poliéster / 24% Polyester
14% Fibra de vidrio / 14% Glass fiber

2

Und.

Guante protección

Gant de protection
Schutzhandschuh
Protection glove
Luva de protecção

Ref	€	Talla	Medida	Perim. mano	L (cm)	U.Venta
61101	16.91	M	8	182 mm	24	1
61102	16.91	L	9	192 mm	25	1
61103	16.91	XL	10	204 mm	26	1



Ambidiestro, cómodos y ligeros.
Para el procesado y corte de alimentos.
NO emplear con sierras giratorias o dentadas.

Ambidextrans, pratiques et légers
Pour la transformation et la découpe des aliments
NE PAS utiliser avec des scies giratoires ou dentées.

Beidhändig verwendbar, bequem und leicht
Zur Bearbeitung und zum Schneiden der Lebensmittel
NICHT mit Kreissägen oder gezahnten Sägen verwenden.

Ambidextrous, comfortable and light
For the processing and cutting of food
Do NOT use with rotating or toothed saws.

Ambidiestro, cómodos e leves.
Para processar e cortar alimentos.
NÃO utilizar com serras giratórias ou dentadas.

Resistencia al corte
Blade cut resistance **4**

Resistencia a la abrasión
Abrasion resistance **5**

Resistencia al punzado
Puncture resistance **4**

Resistencia al desgarro
Tear resistance



Inox

Guante cota

Gant en maille
Netz-Handschuh
Chainmail glove
Luva de malha

Ref	€	Talla	Medidas	Perim. mano	Color	U.Venta
39169	119.62	S	7	171 mm	Blanco/White	1
39170	119.62	M	8	182 mm	Rojo/Red	1
39171	119.62	L	9	192 mm	Azul/Blue	1
39172	119.62	XL	10	204 mm	Naranja/Orange	1



Guante cinco dedos con correa en la muñeca.
Reversible para mano derecha como izquierda.
Código de identificación para servicio de seguimiento.
Diseño de correa extraíble y protección completa de mano.
Fácil lavar y desinfectar.

Gant cinq doigts avec courroie au poignet
Réversible pour main droite ou gauche
Code d'identification pour service de suivi
Conception de courroie extractible et protection complète de la main
Facile à laver et désinfecter

Fingerhandschuh (mit) Riemen am Handgelenk
Für rechte und linke Hand wandbar
Identifikationscode zur Nachverfolgung
Herausnehmbarer Riemen und vollständiger Handschutz
Leicht zu reinigen und zu desinfizieren

Five-finger glove with strap on the wrist
Reversible for both right and left hand
Identification code for monitoring service
Detachable strap and complete hand protection design
Easy to wash and disinfect

Luva de cinco dedos com correia no punho
Reversível, para a mão direita ou esquerda
Código de identificação para serviço de seguimento
Design com correia extraível e proteção total da mão
Fácil de lavar e desinfetar



Inox

Delantal cota de malha

Tablier en maille
Kettenhemd Schürze
Metal butcher's apron
Avental de malha

Ref	€	cm	Perímetro	U.Venta
39165	277.32	80x55	95-145 cm	1

Ajustable gracias a sus tirantes verticales y horizontales.
Conviene asegurarse de que las medidas del cuchillo empleado no sean inferiores a:

Ajustable grâce à ses bandes verticales et horizontales
Il convient de s'assurer que les dimensions du couteau utilisé ne sont pas inférieures à

Anpassbar, dank seiner vertikalen und horizontalen Feststellvorrichtung
Sie sollten sich vergewissern, dass die Größen der verwendeten Messer nicht kleiner sind als:

Adjustable thanks to its vertical and horizontal straps
Care must be taken to ensure that the knife used does not measure less than

Ajustável graças aos seus tirantes verticais e horizontais
É conveniente certificar-se de as dimensões da faca utilizada não serem menores de:



▶ CUCHILLOS PROFESIONAL

54-58 MOLYBDÂNSTAHL Mango Antideslizante
mic X 45 Cr Mo V 15 Non slip handle knives

Acero inoxidable al cromo-molibdeno-vanadio
 Chrome-molybdenum-vanadium stainless steel



Cuchillo CHEF
 Couteau de chef
 Messer Chef
 Cook's knife
 Faca Chef

Ref	€	cm	U.Venta
49016	5,91	16	12
49021	8,82	21	12
49025	10,38	25	12
49030	11,21	30	12



Cuchillo cocina
 Couteau de cuisine
 Küchenmesser
 Kitchen knife
 Faca cozinha

Ref	€	cm	U.Venta
49110	4,15	10	12
49112	4,15	12	12
49116	4,77	16	12
49121	6,23	21	12



Cuchillo patatero
 Couteau office
 Gemüsemesser
 Paring knife
 Faca batatas

Ref	€	cm	U.Venta
49185	3,74	8,50	12



Cuchillo jamonero
 Couteau à jambon
 Schinkenmesser
 Ham knife
 Faca de presunto

Ref	€	cm	U.Venta
49024	7,06	26	12



Cuchillo deshuesador
 Couteau à désosser
 Ausbeinmesser
 Boning knife
 Faca desossador

Ref	€	cm	U.Venta
49014	4,57	14	12



Cuchillo pan
 Couteau à pain
 Brotmesser
 Bread knife
 Faca de pão

Ref	€	cm	U.Venta
49027	6,43	21	12



Tenedor de trinchar
 Fourchette de chef
 Tranchiergabel
 Cook's fork
 Garfo de trinchar

Ref	€	cm	U.Venta
49017	5,50	18	12



Cuchillo Santoku
 Couteau Santoku
 Messer Santoku
 Santoku knife
 Faca Santoku

Ref	€	cm	U.Venta
49210	5,50	10	12
49212	6,64	12	12
49216	9,13	16	12

▶ CUCHILLOS CLASSIC

54-58 Molybdänstahl Cuchillo torjado
mm: X 45 Cr Mo V 15 Forged Intives

Acero inoxidable al cromo-molibdeno-vanadio
Chrome-molybdenum-vanadium stainless steel

Cuchillo CHEF

Couteau de chef
Messer Chef
Cook's knife
Faca Chef

Ref	€	cm	U.Venta
39016	17,33	16	1
39021	21,27	21	1
39025	24,28	25	1
39030	31,13	30	1



Cuchillo cocina

Couteau de cuisine
Küchenmesser
Kitchen knife
Faca cozinha

Ref	€	cm	U.Venta
39110	8,92	10	1
39112	10,06	12	1
39114	11,41	14	1
39116	13,80	16	1
39118	15,96	18	1
39121	16,08	21	1
39125	17,33	25	1



Cuchillo Pescado / Fileteador

Couteau filet-de-sole
Filetmesser
Filetting/fish knife
Faca peixe / Filetes

Ref	€	cm	U.Venta
39115	11,41	20	1



Cuchillo deshuesador

Couteau à désosser
Ausbeinmesser
Boning knife
Faca desossador

Ref	€	cm	U.Venta
39014	13,80	14	1



Cuchillo patatero

Couteau olices
Gemüsemesser
Paring knife
Faca batatas

Ref	€	cm	U.Venta
39185	9,34	8,50	1



Cuchillo fiambre, pastel

Couteau pour charcuterie
Wurst-/Gyrosmesser
Salame slicer
Faca fiambre e doce

Ref	€	cm	U.Venta
39023	16,19	21	1



Cuchillo jamonero

Couteau à jambon
Schinkenmesser
Ham knife
Faca de presunto

Ref	€	cm	U.Venta
39020	17,86	21	1
39024	20,13	26	1



Cuchillo pan

Couteau à pain
Brotmesser
Bread knife
Faca de pão

Ref	€	cm	U.Venta
39027	16,19	21	1





Cuchillo congelados

Couteau aliments surgelés
Gefrierwarenmesser
Frozen food knife
Faca congelados

Ref	€	cm	U.Venta
39028	16.81	21	1



Tenedor de trinchar

Fourchette de chef
Tranchiergabel
Cook's fork
Garfo de trinchar

Ref	€	cm	U.Venta
39017	14.32	18	1



Chaira

Fusil à affûter
Wetzstahl
Sharpening steel
Fusil

Ref	€	cm	U.Venta
39010	18.05	21	1



Machete

Couperet
Hackfleischmesser
Cleaver
Cutelo

Ref	€	cm	U.Venta
39015	49.39	15	1



Macheta

Couperet
Hackfleischmesser
Cleaver
Cutelo

Ref	€	cm	U.Venta
39018	18.36	17x8	1

Inox	ABS	5Cr15MoV
HRC56+/-2	Plástico	Compositos

New

Fabricada en acero inoxidable, con una dureza de HRC56+/-2 (Composición: 5Cr15MoV).
Mango de ABS con remaches en acero inoxidable anti-corrosión.
Ideal para uso doméstico como profesional.
Muy útil para cortar alimentos duros, así como huesos, nervios, cartilagos, etc.
El equilibrio y balance de pesos de la macheta favorece el corte.

Fabriquée en acier inoxydable, avec une dureté de HRC56+/-2 (Composition: 5Cr15MoV).
Manche en ABS avec des rivets en acier inoxydable anti-corrosion.
Idéal aussi bien pour un usage domestique que professionnel.
Très utile pour couper les aliments durs, ainsi que les os, les nerfs, le cartilage, etc.
L'équilibre et poids du couteau favorise la coupe.

Made from stainless steel, with a hardness of HRC56+/-2 (Composition: 5Cr15MoV).
ABS handle with anti-rust rivets.
Perfect for use in the home and by professionals.
Very useful for cutting hard food, as well as bones, nerves, cartilage, etc.
The equilibrium and weight of the cutlery favors the cut.

Taco 8 / 8 piezas

6 pcs bloc
Messerhalter Set, 6-fig
6 pc bloc
Taco 5 peças

Ref	€	Piezas	U.Venta
39000	113.19	6	1 6 piezas
39001	138.40	8	1 8 piezas



COMPOSICIÓN (6 pcs.):

- * Cuchillo Chef 21 cm (39021)
- * Cuchillo de cocina de 16 cm (39110)
- * Cuchillo de cocina de 16 cm (39116)
- * Cuchillo deshuesador 14 cm (39014)
- * Cuchillo jehocoso 20 cm (39020)
- * Chaira (39010)

COMPOSICIÓN (8 pcs.):

- * Cuchillo Chef 21 cm (39021)
- * Cuchillo de cocina de 16 cm (39110)
- * Cuchillo de cocina de 16 cm (39116)
- * Cuchillo deshuesador 14 cm (39014)
- * Cuchillo jehocoso 20 cm (39020)
- * Cuchillo par (39027)
- * Tenedor trinchar (39017)
- * Chaira (39010)

Maleta 9 piezas

9 pcs malette de chef
Messertasche, 9-tlg
9 pc cook's case
Maia 9 peças



COMPOSICIÓN:

- * Cuchillo de cocina de 10 cm (39110)
- * Cuchillo de cocina de 15 cm (39116)
- * Cuchillo de cocina de 25 cm (39126)
- * Cuchillo desmenuador 14 cm (39014)
- * Cuchillo jamonero 20 cm (39020)
- * Cuchillo Chef 25 cm (39025)
- * Limador pinchar (39117)
- * Macheta (39015)
- * Chama (39010)

Ref	€	U.Venta
39004	299,01	1



Set 6 cuchillos chuleteros

6 couteau steak,
6 steakmesser,
6 pcs steak knives
Conjunto 6 facas carne

	Ref	€	L (cm)	U.Venta
A	39060	13,28	21	12
B	39061	12,66	21	12



Taco 5 cuchillos

5 couteau de Chef Bloc
5 Messer Chef Set
5 Chef knife block
Taco 5 facas Chef

Ref	€	U.Venta
39064	55,92	1



Cuchillo corta verduras

Couteau pour coupe légumes
Gemüsemesser
Vegetables knife
Faca corta verduras



Ref	€	L (cm)	U.Venta
60386	1,65	18	24



Inox
18/10

6 ganchos carnicero 1 punta

6 crochets de boucher 1 conseil
6-Tig Metzgerhaken, 1 spitze
6 butchers hook 1 point
6 ganchos de carnicero 1 ponta

	Ref	€	Ø (mm)	L (cm)	U.Venta
A	39043	9,96	5	12,5	4
B	39044	15,46	5	18,5	1



Inox
18/10

6 ganchos carnicero 2 puntas

6 crochets de boucher 2 conseils
6-Tig Metzgerhaken, 2 spitzes
6 butchers hook 2 points
6 ganchos de carnicero 2 pontas

	Ref	€	Ø (mm)	L (cm)	U.Venta
A	39047	9,96	5	12,5	4
B	39048	15,46	5	18,5	1



▶ CUCHILLOS CERAMIC



Cuchillo cocina
 Couteau de cuisine
 Küchenmesser
 Kitchen knife
 Faca cozinha

	Ref	€	cm	U.Venta
A	39208	9,13	8	1
B	39210	10,06	10	1
C	39212	17,02	12	1
D	39215	22,10	15	1
E	39218	32,79	18	1
F	39213	20,44	12	1



Con funda protectora
 With protective sheath

CZ | **87**
 Ceramic | HRC

**Mango ergonómico antideslizante, con un diseño moderno e innovador.
 Resistentes, ligeros e higiénicos.
 NO oxida los alimentos.
 El filo se mantiene hasta diez veces más que los cuchillos convencionales.**

Manche ergonomique antidérapant, le tout avec un design moderne et novateur.
 Résistants, légers et hygiène.
 NO oxyde alimentaire.

Le tranchant reste aiguisé jusqu'à dix fois plus longtemps que les couteaux conventionnels.

Ergonomische und rutschfeste Griffe, modernes und innovatives Design.
 Widerstandsfähig, leicht und hygienisch. Oxidiert keine Lebensmittel.
 Die Schneide bleibt bis zu zehnmal länger scharf als bei herkömmlichen Messern.

Ergonomic non-slip handles, modern and innovative design.
 Resistant, light and hygiene.
 NO oxidizes food.
 The edge remains sharp up to ten times longer with conventional knives.

Cabo ergonómico antideslizante, con um design moderno e inovador.
 Resistentes, leves e higiena.
 NÃO oxida os alimentos.
 A aresta permanece afiada até dez vezes mais com facas convencionais.

Apto para cuchillos
 cerámicos e inoxidable
 Suitable for knives
 ceramic and stainless.



Chaira DIAMANTE
 Fusil à aigüer DIAMANT
 Wetzstahl, DIAMANT
 DIAMOND sharpening steel
 Fusil DIAMANTE

Ref	€	cm	U.Venta
39075	30,61	21	1

TIJERAS

Inox



Tijeras de cocina AVES

Ciseaux pour volaille AVES
Geflügelschere, AVES
AVES poultry shears
Tesouras de cozinha AVES

Ref	€	cm	U.Venta
60001	16,19	7.5x27	12



Soporte magnético
Magnetic holder



Tijeras cocina con funda

Ciseaux pour cuisine avec housse
Geflügelschere mit Überzug
Kitchen scissor with sheath
Tesouras de cozinha com capa

Ref	€	L (cm)	U.Venta
60059	8,61	21,5	6



Tijera-Cuchillo desmontable SANTOKU

Ciseaux amovible
Auseinandernehmbare Schere
Dismountable scissors knife
Tesoura removível

Ref	€	L (cm)	U.Venta
60050	7,47	23,50	1



Tijera-Desescamador desmontable

Ciseaux Ecailleur amovible
Auseinandernehmbare Schere-Fischschuppe
Dismountable scissors-Scrapper
Tesoura Raspador removível

Ref	€	L (cm)	U.Venta
60051	4,98	23,00	1



Protector y cepillo de limpieza
Protector and cleaning brush

Tijeras 5 cortes + Peine de limpieza

Ciseaux 5 coupe + peigne pour nettoyage
5-fach Schneideschere + Reinigungs Kamm
5 Cuts vegetable scissor+cleaning comb
Tesouras 5 cortes + Peine de limpeza

Ref	€	cm	U.Venta
60022	7,16	27x13x3	6



- 1.- Tijeras - Scissors
- 2.- Abrebotellas - Unscrew
- 3.- Cascanueces - Nut cracker

50-54
mm

Tijeras Profesional Inox

Ciseaux Profesional en inox
Geflügelschere Profesional
St. Steel Professional scissors
Tesouras Profesional Inox

Ref	€	cm	U.Venta
38010	18,78	7.0x20	12

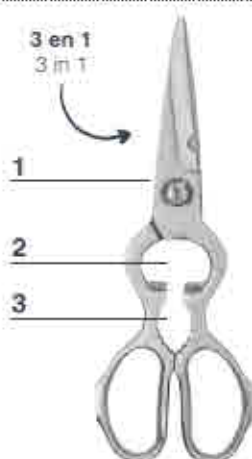

Tijeras de cocina

Ciseaux pour cuisine
Küchenschere
Kitchen shears
Tesouras de cozinha

Ref	€	cm	U.Venta
60018	9,34	8.5x21	1
60019	9,13	8.5x22	1
60023	9,44	8.5x24	1



SOPORTES MAGNÉTICOS



Potente imán en el interior para sujetar con seguridad los cuchillos, tijeras y otros artículos metálicos.
Incluyen un set de montaje para instalar el soporte de cuchillos sobre cualquier tipo de pared.

Puissant aimant à l'intérieur pour tenir en toute sécurité les couteaux, les ciseaux et tout autre ustensile métallique.
Inclu un set de montage pour installer le support à couteaux sur tout type de mur.

Starker Magneteisen – hält Messer, Scheren und andere Gegenstände aus Metall sicher und fest.
inkl. Montagesatz zum Anbringen des Messerhalters an jeder Art von Wand.

It has a powerful magnet inside for safely holding knives, scissors or other metal items.
Installation hardware for mounting the support on any kind of wall is included.

O seu potente imã interior permite sujetar com segurança as facas, tesouras e outros utensílios metálicos.
Inclui um kit de montagem para instalar o suporte para facas em qualquer tipo de parede.

Soporte magnético cuchillos
Support magnétique pour couteaux
Magnethalterung für Messer
Magnet support for knives
Suporte magnético de facas

Ref	€	Total (cm)	Útil (cm)	U.Venta
39008	7,68	38	35,0	12
39009	9,23	55	52,3	12

Potente imán
Powerful magnet

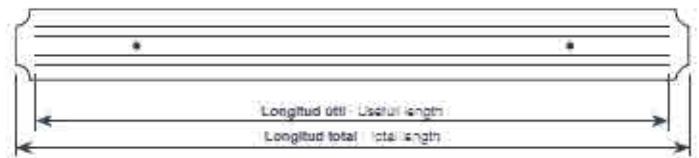

Madera caucho
Rubber Wood



Soporte magnético cuchillos
Support magnétique pour couteaux
Magnethalterung für Messer
Magnet support for knives
Suporte magnético de facas

Ref	€	Total (cm)	h (cm)	Útil (cm)	U.Venta
39108	23,76	36	6	33	1
39109	27,81	45	6	42	1

Potente imán
Powerful magnet

Madera de caucho
Rubber Wood

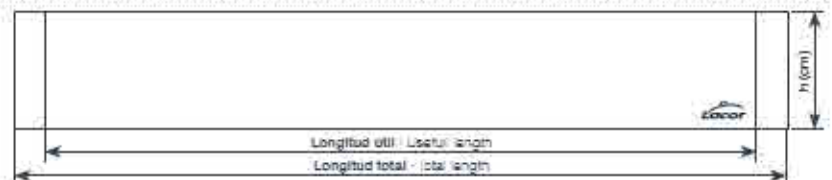

Parte trasera del soporte / Back of the support

▶ AFILADORES · ABRELATAS

Cuchillos afilados en segundos
Sharp knives in seconds



Base de goma antideslizante, garantiza mayor seguridad
Non-slip rubber base, guarantees better safety.



Afila cuchillos de filo liso.
2 zonas de afilado: Afilado standard y afilado alta precisión.
Cada zona consta de: 2 discos de acero de carburo duro (grosso) para vaciar bordes.
2 discos de cerámica fina para terminar el borde.
Fácil de usar, empuje el filo en un ángulo de 90° con una ligera presión.
Asa con goma y ranuras para los dedos que proporciona un manejo sencillo y seguro.

Aiguseur pour lames lisses.
2 zones d'affûtage: Affûtage standard et affûtage de haute précision.
Chaque zone est composée de: 2 disques en acier au carbure dur (épais) pour restaurer le fil.
2 disques en céramique fine pour terminer le fil.
Facile à utiliser: pousser la lame à un angle de 90° avec une légère pression.
Poignée avec caoutchouc et rainures pour les doigts qui confère une prise en main simple et sûre.

Zum Schärfen von glatten Klingen.
2 Schärffzonen: Standard-Schärfen und Hochpräzisions-Schärfen.
Jede Zone besteht aus: 2 Scheiben aus gehärtetem Karbid für den Grobschliff.
2 Scheiben aus Feinkeramik für den Feinschliff.
Einfach zu handhaben: der Schliff erfolgt, indem die Klinge im 90° Winkel mit leichtem Druck durch die Öffnung geschoben wird.
Gummigriff mit Öffnungen für die Finger ermöglicht sichere und einfache Anwendung.

Sharpen smooth blade knives.
2 sharpening zones: Standard sharpening and high precision sharpening.
Each zone consists of: 2 thick carbide steel rods for cleaning up edges.
2 thin ceramic rods for honing edges.
Easy to use: Push the knife at a 90° angle using light pressure.
Rubber handle with finger grooves for safe and easy use.

Afiador para facas de lâmina lisa.
2 zonas de afilar: Afilção padrão e afilção de alta precisão.
Cada zona consiste em: 2 discos de aço carbono duro (grosso) para restaurar bordas.
2 discos de cerâmica fina para terminar a borda.
Fácil de usar: basta empurrar a lâmina com uma inclinação de 90°, exercendo uma ligera pressão.
Asa com borracha e ranhuras para os dedos, para uma manipulação fácil e segura.



Afilador de cuchillos DUAL

Affûteuse de couteaux
Schärfmaschine
Knives sharpener
Afiador de facas

Ref	€	cm	U.Venta
39266	16,08	21.5x4.5x9	1



Afilador de cuchillos

Affûteuse de couteaux
Schärfmaschine
Knife sharpener
Afiador de facas

Ref	€	U.Venta
39065	8,40	6



Un mejor agarre
A better grip



Afilador de cuchillos eléctrico

Affûteuse de couteaux électrique
Elektrische Schärfmaschine
Electric knife sharpener
Afilador de facas electrónico

Ref.	€	U.Venta
69141	27,29	1



Cuchillos
lisos y dentados
Smooth and serrated knives



Afilador de cuchillos eléctrico

Affûteuse de couteaux électrique
Elektrische Schärfmaschine
Electric knife sharpener
Afilador de facas electrónico

Ref.	€	U.Venta
69261	106,86	1

Fase 1 Fase 2 Fase 3



Fase 1: Alta abrasividad - High abrasiveness
Fase 2: Afilado fino - Thin sharp
Fase 3: Micro-afilado - Micro-sharp



Afilador de cuchillos eléctrico

Affûteuse de couteaux électrique
Elektrische Schärfmaschine
Electric knife sharpener
Afilador de facas electrónico

Ref.	€	U.Venta
60359	42,23	1

Ref.	Tensión/Voltage	Potencia/Power	Dimensiones/Sizes	Peso/Weight
69141	220-240 V / 50 Hz	60 W	13,5x15x9 cm	0,64 Kg
69261	220-240 V / 50-60 Hz	80 W	32x11,5x10 cm	2,20 Kg
60359	220-240 V / 50-60 Hz	60 W	16x11x7,5 cm	0,58 Kg



Abrelatas de mesa profesional

Ouvre-boîte de table professionnel
Profe-Dosenöffner für Tisch
Professional table tin opener
Abre-latas de mesa profesional

Ref.	€	U.Venta
69005	110,29	1
69015	162,58	1

Altura máx. de lata: 30 cm
Maxime height of canister: 30 cm



Inox

Abrelatas

Ouvre-boîte
Dosenöffner
Can opener
Abre-latas

Ref.	€	cm	L (cm)	U.Venta
A 62689	23,24	5x4	20	6
B 63038	19,40	5x4	17	1

▶ TABLAS DE CORTE MADERA



Robustas y muy resistentes. Fabricadas en bambú natural y madera de caucho. Perfectas para colocar sobre la encimera de la cocina. Ideales para cortar todo tipo de alimentos.

Robustes et très résistantes. Fabricées en bambou naturel et en bois d'hévéa. Parfaites pour installer sur le plan de travail de la cuisine. Idéales pour couper tout type d'aliments.

Widerstandsfähig und belastbar. Aus natürlichem Bambus- und Kautschukholz. Passen perfekt auf die Arbeitsfläche in der Küche. Ideal zum Schneiden aller möglichen Zutaten.

Strong and highly resistant. Made from natural bamboo and rubberwood. Perfect for placing on kitchen counters. Ideal for cutting any type of food.

Robustas e resistentes. Fabricadas em bambu natural e madeira de caucho. Perfeitas para colocar sobre a bancada da cozinha. Ideais para cortar todo o tipo de alimentos.

Bambú
Bamboo

Tabla de corte pan
Planche à découper pain
Schneidebrett brot
Bread cutting board
Tábua de corte pão



Ref	€	cm	h (cm)	U.Venta
60487	24.69	40x30	2	1

Bambú
Bamboo

Tabla de corte pan
Planche à découper pain
Schneidebrett brot
Bread cutting board
Tábua de corte pão

Ref	€	cm	h (cm)	U.Venta
60495	19.40	50x15	2	1



Bambú
Bamboo

Tabla de corte pan oval
Planche à découper pain ovale
Schneidebrett oval brot
Oval bread cutting board
Tábua de corte pão oval



Ref	€	cm	h (cm)	U.Venta
60491	30.81	40x27	3	1



Bambú
Bamboo

Tabla de corte DUAL
Planche à découper
Schneidebrett
Cutting board
Tábua de corte

Ref	€	cm	h (cm)	U.Venta
60492	31.44	39,5x38	4	1

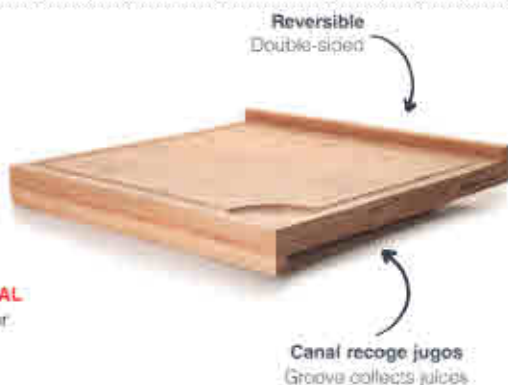

Madera Caucho
Rubber Wood

Tabla de corte RUBBER WOOD
Planche à découper
Schneidebrett
Cutting board
Tábua de corte

Ref	€	cm	h (cm)	U.Venta
60488	30.09	33x25	4	1
60485	58.93	53,3x32,8	4	1

Revestimiento protector y anti-bacteriano
Protective and anti-bacterial coating



Las fibras colocadas verticalmente ayudan a mantener el filo de los cuchillos

The fibres are arranged vertically to help knife blades retain

Incluye cubeta
Includes container



Tabla de corte COLLET HOME

Plancha à découper
Schneidebrett
Cutting board
Tábua de corte

Ref	€	Tabla (cm)	Cubeta (cm)	U.Venta
60594	25,63	35x29x4	-	1
R60594A	4,25	-	34x26,5x2	1

Cubeta | Tray



New

Tabla de corte tratada con un revestimiento protector y anti-bacteriana.
Cubeta extraíble para recoger los alimentos cortados.
Pies antideslizantes, garantiza la estabilidad de la tabla durante el corte.
Cubeta apta para el lavavajillas.

Planche à découper traitée avec un revêtement de protection et antibactérien.
Bacs extractibles pour accueillir les aliments coupés.

Pieds antidérapants qui garantissent la stabilité de la planche à découper pendant la découpe.

Passage au lave vaisselle ou bac uniquement.

Cutting board treated with a protective and anti-bacterial coating.

Removable tray for collecting chopped food.

Non-slip feet ensure the board remains stable when cutting.

Dishwasher safe tray.

Incluye cubeta
Includes container



Tabla de corte COLLECT GN 2/3

Plancha à découper
Schneidebrett
Cutting board
Tábua de corte

Ref	€	Tabla (cm)	Cubeta (cm)	Cubeta (L)	U.Venta
60592	61,11	41,5x34x7	-	-	1
* 66540Z	18,99	-	35,4x32,5x4	3,50	1

Cubeta | Tray

* Apta cubeta inox 18/10 (66540) - Suitable for 18/10 stainless steel tray (66540)



Madera
Caucho
Rubber Wood

Inox

Práctica tabla de corte con una o dos cubetas de acero inoxidable ocultas completamente extraíbles.

Las fibras colocadas verticalmente ayudan a mantener el filo de los cuchillos afilado durante más tiempo.

Tabla de corte tratada con un revestimiento protector y anti-bacteriana.

Cubeta extraíble para recoger los alimentos cortados.

Cubeta apta para el horno (hasta 250°C) y el lavavajillas.

Pies antideslizantes, garantiza la estabilidad de la tabla durante el corte.

Planche à découper pratique avec un ou deux bacs en acier inoxydable totalement extractibles.

Les fibres placées verticalement aident à maintenir le fil de la lame des couteaux aiguisés plus longtemps.

Planche à découper traitée avec un revêtement de protection et antibactérien.

Bacs extractibles pour accueillir les aliments coupés.

Bacs aptes pour le four (jusqu'à 250°C) et le lave-vaisselle.

Pieds antidérapants qui garantissent la stabilité de la planche à découper pendant la découpe.

Handy cutting board with one or two completely removable stainless steel trays.

The fibres are arranged vertically to help knife blades retain their sharpness for longer.

Cutting board treated with a protective and anti-bacterial coating.

Removable tray for collecting chopped food.

Tray is oven-safe (up to 250°C) and dishwasher safe.

Non-slip feet ensure the board remains stable when cutting.

Incluye cubetas
Includes containers



Tabla de corte COLLECT 2xGN 1/2

Plancha à découper
Schneidebrett
Cutting board
Tábua de corte

Ref	€	Tabla (cm)	Cubeta (cm)	Cubeta (L)	U.Venta
60591	85,59	61,5x34x7	-	-	1
* 66240Z	10,06	-	26,5x32,5x4	2,5 x 2	1

Cubeta | Tray

* Apta cubeta inox 18/10 (66240) - Suitable for 18/10 stainless steel tray (66240)



Acacia | Cristal
Wood | Glass

Set de cuchillos para Queso

Jeu de couteaux pour le fromage
Set von Messern für Käse
Knives set
Jogo de facas para queijo

Ref	€	Ø (cm)	h (cm)	U.Venta
60072	40,46	25	5	1

Fabricada en robusta madera de acacia.

Superficie de corte en cristal con un Ø25 cm.

Incluye 4 cuchillos fabricados en acero inoxidable con mango de madera.
Ideal para cortar quesos y presentarlos sobre la misma.

Fabriquée en bois d'acacia robuste.

Surface de découpe en verre avec un Ø de 25 cm.

Inclu: 4 couteaux fabriqués en acier inoxydable avec manche en bois.

Idéale pour couper le fromage et le présenter à table.

Aus robustem Akazienholz gefertigt.

Schneidefläche aus Glas mit einem Durchmesser von Ø25 cm.

Dazu gehören 4 Messer aus Edelstahl mit Holzgriff.

Ideal zum Käse schneiden und präsentieren.

Made of sturdy acacia wood - Ø25cm glass cutting surface.

Includes 4 stainless steel knives with wooden handles.

Ideal for cutting and serving cheese.

Fabricada em madeira de acácia de grande robustez.

Superfície de corte de vidro, com Ø25 cm.

Inclui 4 facas de aço inoxidável, com cabo de madeira.

Ídeal para cortar e apresentar queijos.

▶ TABLAS DE CORTE FIBRA DE MADERA

New



Fabricadas en fibra de madera, materiales naturales y ecológicos

Made from wood fibre, a natural and eco-friendly material



Tabla de corte fabricada en fibra de madera, materiales naturales y ecológicos. Duradera, resistente, indeformable y anti-bacteriana.

Las fibras de madera ayudan a mantener el filo de los cuchillos afilado durante más tiempo.

Su diseño permite darle un doble uso, tanto para la cocina como para el servicio en mesa y se pueden usar por ambos lados.

GRIPsystem, pies singulares fabricados en silicona para utilizar las tablas en cualquier superficie sin riesgo de deslizamiento.

El orificio es perfecto para colgar la tabla y facilitar su almacenaje.

Fácil de limpiar gracias a su acabado liso, no poroso. Apta para el lavavajillas.

Plancha à découper fabriquée en fibres de bois, un matériau naturel et écologique. Durable, résistante, indéformable et antibactérienne.

Les fibres de bois aident à maintenir le fil des couteaux aiguisés plus longtemps. Sa forme permet de lui donner un double usage, à la fois pour la cuisine et pour le service à table, et elle est utilisable des deux côtés.

GRIPsystem, pieds exclusifs en silicone pour utiliser les planches sur n'importe quelle surface sans risque de glisser.

L'orifice est parfait pour suspendre la planche et faciliter son rangement.

Facile à nettoyer grâce à sa finition lisse, non poreuse. Elle est apte pour le lave-vaisselle.

Schneidebrett aus Holzfasern sowie Natur- und Öko-Stoffen. Haltbar, widerstandsfähig, formbeständig und antibakteriell.

Holzfasern hält Messer länger scharf und schonen ihren Schilff. Doppelseitig verwendbar für den Einsatz in der Küche oder als Servierbrett.

GRIPsystem, exklusive Füße aus Silikon, um die Bretter auf jeder Oberfläche ohne Rutschgefahr zu verwenden.

Praktische Öffnung zum Aufhängen oder Verstauen.

Glatte, porinfreie Oberfläche ist einfach zu reinigen. Spülmaschinengeeignet.

Chopping board made from wood fibre, a natural and eco-friendly material.

Durable, resistant, anti-bacterial and its shape doesn't warp.

The wood fibres help keep the knife blade sharper for longer.

Its design allows you to use both for the kitchen and for serving food on the table.

GRIPsystem, exclusive feet made of silicone to use the boards on any surface without risk of slipping.

The hole is perfect for hanging the board and it makes it easier to store.

It's easy to clean thanks to its smooth, non-porous finish. It's suitable for washing machines.

Tábua de cortar fabricada em fibra de madeira, materiais naturais e ecológicos. Durável, resistente, indeformável e antibacteriana.

As fibras de madeira ajudam a manter a lâmina das facas afilada durante mais tempo.

O seu design proporciona-lhe uma dupla utilização: tanto para a cozinha quanto para servir à mesa. Utilizável por ambos os lados.

GRIPsystem, pés exclusivos feitos de silicone para usar as pranchas em qualquer superfície sem risco de escorregar.

Orifício para pendurar a tábua, e facilitar o seu armazenamento.

Fácil de limpar, graças ao seu acabamento liso e não poroso. Apta para a máquina de lavar louça.



Tablas de corte reversibles
Reversible cutting boards



Tabla de corte BLACK
Planche à découper
Schneidebrett
Cutting board
Tábua de corte



Ref	€	cm	e (mm)	U.Venta
60580	15,98	30x21,5	6	1
60581	21,48	37x27,5	6	1
60582	30,50	44x32,5	6	1

Canal que recoge el jugo de los alimentos.
Channel that collects the juice from your food.

GRIPsystem



Tabla de corte NATURAL

Planche à découper
Schneidebrett
Cutting board
Tábua de corte

Ref	€	cm	e (mm)	U.Venta
60583	16,81	30x23,5	6	1
60584	20,65	37x27,5	6	1
60585	29,67	44x32,5	6	1

Canal que recoge el jugo de los alimentos.
Channel that collects the juice from your food.

GRIPsystem



Tabla de corte NOGAL

Planche à découper
Schneidebrett
Cutting board
Tábua de corte

Ref	€	cm	e (mm)	U.Venta
60586	14,63	26,5x19,5	6	1
60587	18,47	30x23,5	6	1
60588	28,84	40x30	6	1

▶ TAJO DE CORTE CARNICERO

New



Fabricada en polietileno de alta densidad. Espesor de 5 mm.
Ideal para cocinas profesionales, carnicerías, pescaderías, etc.
Su dureza le confiere una mayor resistencia a la abrasión, durabilidad y una gran absorción de los golpes.
Material no poroso que facilita su limpieza. No acumula olores ni sabores.
Apta para lavavajillas.
Cumple con todas las garantías sanitarias para la manipulación de alimentos exigidas por la unión europea.

Fabriquée en polyéthylène de haute densité. Épaisseur de 5 mm.
Idéale pour les cuisines professionnelles, les boucheries, les poissonneries, etc.
Sa dureté lui confère une plus grande résistance à l'abrasion, et une durabilité et une absorption des chocs accrues.
Matériau non poreux qui facilite son nettoyage. Ne garde ni les odeurs ni les goûts.
Apte pour le lave-vaisselle.
Répond à toutes les garanties sanitaires pour la manipulation d'aliments exigées par l'Union Européenne.

Hergestellt aus hochdichtem Polyethylen. Dicke 5 mm.
Ideal für Profiküchen, Metzgereien, Fischhandlanger usw.
Seine Härte macht es widerstandsfähiger gegen Abrieb. Haltbar und stark stoßabsorbierend.
Nicht-poröses Material zur Erleichterung der Reinigung. Nimmt keine Gerüche oder Aromen an.
Geschirrspülmaschinenfest.
Es erfüllt alle von der Europäischen Union geforderten Gesundheitsgarantien für den Umgang mit Lebensmitteln.

Made of high density polyethylene 5 mm Thick.
Perfect for professional kitchens, butcher shops or fishmongers, etc.
Its hardness gives it greater resistance to abrasion, more durability and high impact absorption.
The non porous material makes it easy to clean. There is no build-up of odours or flavours.
Dishwasher safe.
Meets all health guarantee for food handling required by the European Union.

Fabricado em polietileno de alta densidade. Espessura: 5 mm.
Ideal para cozinhas profissionais, talhos, peixarias, etc.
A sua dureza proporciona-lhe maior resistência à abrasão, durabilidade e grande capacidade de absorção dos golpes.
Material não-poroso, que facilita a sua limpeza. Não acumula cheiros nem sabores.
Apto para máquinas de lavar louça.
Cumprir com todas as garantias sanitárias para manipulação de alimentos exigidas pela União Europeia.

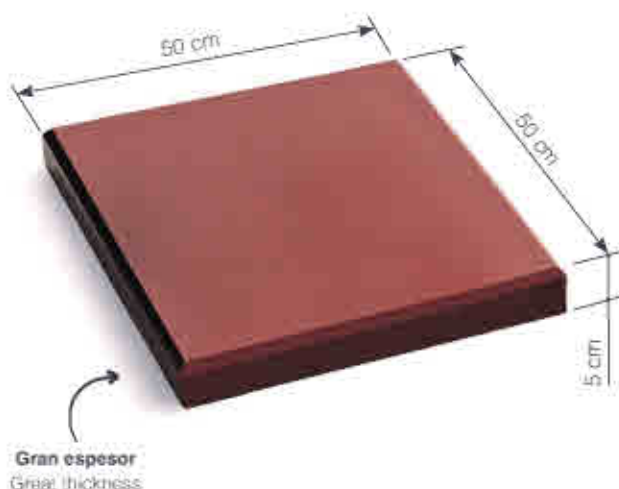

Tajo de corte carnicero

Planche à découper la viande
Metzger-Schneidblock
Butcher Block
Cepo de corte de carneiro

Ref	€	cm	h (cm)	Kg	U.Venta
60578	153,48	50x50	5,0	12	1

▶ TABLAS DE CORTE POLIETILENO / POLIPROPILENO



Fabricadas en polietileno de alta densidad y máxima resistencia.
Perfectas para colocar sobre la encimera de la cocina.
Higiénicas y fáciles de limpiar.
Aptas para el lavavajillas.

Fabriquées en polypropylène de haute densité et d'une résistance maximale.
Parfaites pour installer sur le plan de travail de la cuisine.
Hygiéniques et faciles à nettoyer.
Aptes pour le lave-vaisselle.

Aus hochdichtem und extrem strapazierfähigem Polypropylen.
Passen perfekt auf die Arbeitsfläche in der Küche.
Hygienisch und leicht zu reinigen.
Spülmaschinengeeignet.

Made of high density ultra strong polypropylene.
Perfect for placing on kitchen counters.
Hygienic and easy to clean.
Dishwasher safe.

Fabricadas em polipropileno de alta densidade e grande resistência.
Perfeitas para colocar sobre a bancada da cozinha.
Higiénicas e fáceis de limpar.
Aptas para máquinas de lavar louça.

Superficie de corte
de doble cara
Double-sided cutting surface



PE

Polyethylene

Tabla de corte

Planche à découper
Schneidebrett
Cutting board
Tábua de corte



Ref	€	cm	U.Venta
60501	6,85	30x18x1	1
60502	9,23	36x22x1	1
60503	12,45	42x25,5x1	1

PP

Polypropylene

Set 3 tablas de corte

Set 3 planches à découper
Set 3 Schneidebrett
3 cutting boards set
Conjunto 3 tábuas de corte

Ref	€	cm	U.Venta
60500	11,00	20x15 30x20 35x25	1



Reversible
Double-sided



Canal recoge jugos
Groove collects juices

PE

Polyethylene

Tabla de corte DUAL

Planche à découper
Schneidebrett
Cutting board
Tábua de corte

Ref	€	cm	h (cm)	U.Venta
60459	23,97	35x43	5	1



Tacos antiderrapantes
Non slip plugs

PE

Polyethylene

Tabla de corte antialérgica

Pianche à découper
Schneidebrett
Anti-allergy cutting board
Tábua de corte

Especial para alérgicos
Special for allergy sufferers



Especial para preparar comidas que no contengan alérgenos.
Identifíquela rápidamente por su intenso color morado.

Spécialo pour préparer des repas sans allergènes.
Identifíliez-la rapidement grâce à son intense couleur violette.

Zurü Bereiten von allergenfreien Speisen
Leicht an leuchtender lila Farbe zu erkennen

Specialy made for making food that contains no allergens.
Identify it quickly by its deep purple colouring.

Especial para preparar comidas que não contenham alérgenos.
Identifique-a rapidamente pela sua cor roxo vivo.

PE-500 (HD-HMW) High Molecular AA Weight Polyethylene

GN 1/2 - 325x265 mm			
Ref	€	h (mm)	U.Venta
60521	20,23	20	1

GN 1/1 - 530x325 mm			
Ref	€	h (mm)	U.Venta
60522	40,57	20	1

600x400 mm			
Ref	€	h (mm)	U.Venta
60606	49,59	20	1

New



Tacos antiderrapantes
Non slip plugs

PE

Polyethylene

Tabla de corte Polietileno

Pianche à découper en Polyéthylène
Schneidebrett, Polyäthylene
Polyethylene cutting board
Tábua de corte polietileno



- Pescado - Fish ■
- Verduras+frutas - Vegetables+Fruits ■
- Embutidos - Cold cured meat ■
- Carne - Meat ■
- Aves - Poultry ■
- Varios - Various ■

GN 1/4 - 265x162 mm			
Ref	€	h (mm)	U.Venta
60570	9,03	20	1
60571	9,03	20	1
60572	9,03	20	1
60573	9,03	20	1
60574	9,03	20	1
60577	9,03	20	1

GN 1/2 - 325x265 mm			
Ref	€	h (mm)	U.Venta
60470	17,64	20	1
60471	17,64	20	1
60472	17,64	20	1
60473	17,64	20	1
60474	17,64	20	1
60480	17,64	20	1

GN 1/1 - 530x325 mm			
Ref	€	h (mm)	U.Venta
60475	34,86	20	1
60476	34,86	20	1
60477	34,86	20	1
60478	34,86	20	1
60576	98,56	50	1
60479	34,86	20	1
60481	34,86	20	1

New

600x400 mm			
Ref	€	h (mm)	U.Venta
60600	49,59	20	1
60601	49,59	20	1
60602	49,59	20	1
60603	49,59	20	1
60604	49,59	20	1
60605	49,59	20	1

PE-500 (HD-HMW) High Molecular AA Weight Polyethylene



Tacos antiderrapantes
Non slip plugs

PE

Polyethylene

Tabla de corte Polietileno

Pianche à découper en Polyéthylène
Schneidebrett Polyäthylene
Polyethylene cutting board
Tábua de corte Polietileno



GN 1/4 - 265x162 mm			
Ref	€	h (mm)	U.Venta
60569	9,03	20	6

GN 1/2 - 325x265 mm			
Ref	€	h (mm)	U.Venta
60455	17,64	20	6
60405	25,94	30	6

GN 1/1 - 530x325 mm			
Ref	€	h (mm)	U.Venta
60456	34,96	20	1
60406	52,08	30	1
60575	101,05	50	1

60x40 mm			
Ref	€	h (mm)	U.Venta
60457	49,28	20	1
60407	72,94	30	1

Robusta y alta durabilidad
Robust and high durability



Incluye cubeta GN 2/3
Container GN 2/3 included

PE | Inox
Polyethylene | Stainless Steel

Tabla de corte COLLECT GN 2/3

Plancha à découper
Schneidebrett
Cutting board
Tábua de corte

Ref	€	Tabla (cm)	Cubeta (cm)	Cubeta (L)	U.Venta
60593	83,21	41x34x6,5	-	-	1
665402	18,99	-	35,4x32,5x4	3,5	1 Cubeta Tray

* Apta cubeta inox 18/10 (66540) - Suitable for 18/10 stainless steel tray (66540)

Práctica tabla de corte con una cubeta GN 2/3 de acero inoxidable oculta completamente extraíble.

Fabricada en polietileno de alta densidad de color blanco.

Segura, ligera e higiénica, no absorbe humedad y evita la proliferación de bacterias.

Gracias a su superficie suave, protege las hojas de los cuchillos.

Cubeta extraíble (35,4x32,5x4 cm) para recoger los alimentos cortados.

Cubeta apta para el horno (hasta 250°C) y el lavavajillas.

Pies antideslizantes, garantiza la estabilidad de la tabla durante el corte.

Resistente a los cortes y los arañazos.

Plancha à découper pratique avec un bac GN 2/3 en acier inoxydable totalement extraîble.

Fabriquée en polyéthylène de haute densité de couleur blanche.

Sûre, légère et hygiénique, elle n'absorbe pas l'humidité et évite la prolifération des bactéries.

Grâce à sa surface douce, elle protège les lames des couteaux.

Bacs extraîbles (35,4x32,5x4 cm) pour accueillir les aliments coupés.

Bacs aptes pour le four (jusqu'à 250 °C) et le lave-vaisselle.

Pieds antidérapants qui garantissent la stabilité de la planche à découper pendant la découpe.

Résistante aux coupures et aux rayures.

Handy cutting board with one completely removable stainless steel GN 2/3 tray.

Made of white high-density polyethylene.

Safe, light and hygienic, it does not absorb moisture and prevents the growth of bacteria.

It protects knife blades thanks to its smooth surface.

Removable tray (35,4x32,5x4 cm) for collecting chopped food.

Tray is oven safe (up to 250°C) and dishwasher-safe.

Non-slip feet ensure the board remains stable when cutting.

Resistant to cuts and scratches.

Para uso de tablas de Polietileno Profesionales

For use of Professional Polyethylene cutting boards

PE

Polyethylene

Cepillo para tablas de corte

Brosse pour planche à découper

Brush für Schneidebrett

Brush cutting board

Cepilho para tábua de corte

Ref	€	cm	U.Venta
60458	57,06	17x6x10	1



JAMONEROS



Tacos antideslizantes
Non slip plugs

PE | 
Polyethylene

Jamonero

Support pour jambon

Schinkenhalter

Ham-support

Suporte presunto

Ref	€	cm	U.Venta
62344	79,78	50x20,5x35,5	1



Plegable
Folding

Tacos antideslizantes
Non slip plugs

PE | 
Polyethylene

Jamonero abatible

Support pour jambon rabattable

Schinkenhalter, Verstellbar

Folden ham-support

Suporte presunto abatible

Ref	€	cm	U.Venta
62359	78,44	43x19x5	1

CUBIERTOS



- Cuchara mesa - Table spoon
- Tenedor mesa - Table fork
- Cuchillo mesa - Table knife
- Cuchara postre - Dessert spoon
- Tenedor postre - Dessert fork
- Cuchillo postre - Dessert knife
- Cuchara café - Coffee spoon
- Cuchara moka - Moka spoon
- Tenedor Lunch - Lunch fork
- Tenedor pescado - Fish fork
- Pala pescado - Fish knife
- Cazo sopa - Soup ladle
- Cuchara servir - Serving spoon
- Tenedor servir - Serving fork
- Cacillo salsa - Gravy shovel
- Pala pastel - Cake shovel



Soporte cubiertos con vasos

Porte couverts avec paniers
Besteckbehälter
St. Steel cutlery holder w/cylinder
Suporte talheres com copos

Ref.	€	cm	Orif.	U.Venta
33124	72,83	29x22x26	4	1
33126	89,54	29x22x38	6	1

Vasos inox cubertería

Panier pour porte couvert
Besteckköcher
St. Steel cutlery cylinder
Copos p/talheres inox



Ref.	€	h (cm)	U.Venta
33125	6,54	14	6

HOTEL

Inox
18% Cr

Espesor - Thickness: 1,8 mm



Ref.	€	U.Venta	
33101	1,35	12	Cuchara mesa - Table spoon
33102	1,35	12	Tenedor mesa - Table fork
33103	2,28	12	Cuchillo mesa - Table knife
33104	1,14	12	Cuchara postre - Dessert spoon
33105	1,14	12	Tenedor postre - Dessert fork
33106	2,18	12	Cuchillo postre - Dessert knife
33107	0,83	12	Cuchara café - Coffee spoon
33108	0,73	12	Cuchara moka - Moka spoon
33109	0,83	12	Tenedor Lunch - Lunch fork
33110	1,14	12	Tenedor pescado - Fish fork
33111	1,14	12	Pala pescado - Fish knife
33112	8,72	1	Cazo sopa - Soup ladle
33113	4,98	1	Cuchara servir - Serving spoon
33114	4,98	1	Tenedor servir - Serving fork
33116	4,98	1	Pala pastel - Cake shovel

ARIES

Inox
18/10

Espesor - Thickness: 2,5 mm



Ref.	€	U.Venta	
33401	2,18	12	Cuchara mesa - Table spoon
33402	2,18	12	Tenedor mesa - Table fork
33403	4,88	12	Cuchillo mesa - Table knife
33404	2,18	12	Cuchara postre - Dessert spoon
33405	2,18	12	Tenedor postre - Dessert fork
33406	4,88	12	Cuchillo postre - Dessert knife
33407	1,14	12	Cuchara café - Coffee spoon
33408	1,04	12	Cuchara moka - Moka spoon
33409	1,35	12	Tenedor Lunch - Lunch fork
33410	2,18	12	Tenedor pescado - Fish fork
33411	2,18	12	Pala pescado - Fish knife
33412	8,51	1	Cazo sopa - Soup ladle
33413	5,19	1	Cuchara servir - Serving spoon
33414	5,29	1	Tenedor servir - Serving fork
33415	6,74	1	Cacillo salsa - Gravy shovel
33416	5,81	1	Pala pastel - Cake shovel





BUFFET

Chafing Dish

Buffet

▶ CHAFING DISH LUXE



Inox
18/10



Vibro



Electric



Gas



Induction

Tapa con descenso amortiguado para un cierre suave.

Tapa extraíble verticalmente para su limpieza.

Visor de cristal.

Las gotas de condensación retornan a la cubeta.

Salsera lateral para la sujeción de cacillos o espumaderas.

Disponibilidad de aro complementario para el empleo de placa de inducción.

Couvercle avec descente amortie pour une fermeture en douceur.

Couvercle peut s'extraire verticalement pour un nettoyage aisé.

Écran en verre.

Les gouttelettes de condensation retombent dans la cuvette.

Saucière latérale pour la fixation de tanches ou d'écumoirs.

Disponibilité d'anneaux complémentaires pour l'utilisation de plaques à induction.

Deckel mit gedämpfter Abwärtsbewegung für sanftes Schließen.

Deckel zwecks einfacher Reinigung vertikal abnehmbar.

Schauglas.

Rückfluss der Kondens Tropfen in den Wasserbehälter.

Seitliche Sauciere für die Ablage von Schöpfkelle oder Schaumlöffel nach Gebrauch.

Zusatzringe für den Einsatz von Induktionsplatten verfügbar.

Cover with damping seal for smooth closure.

Cover can be removed vertically for easy cleaning.

Glass display.

The condensation droplets return to the receptacle.

Lateral sauceboat for holding scoops and skimmers.

Availability of additional rings for the use of induction hobs.

Tampa com descida amortecida que se fecha suavemente.

Tampa pode ser extraída verticalmente para facilitar a limpeza.

Visor de vidro.

As gotas de condensação regressam à cubeta.

Molheira lateral para sujeitar as conchas ou escumadeiras.

Anéis complementares disponíveis para utilizar em placas de indução.





Chafing Dish GN 1/1 LUXE

Bain marie GN 1/1
Chafing Dish, GN-Einsatz 1/1
GN 1/1 chafing dish
Chafing dish GN 1/1 steel

Ref	€	cm	h (cm)	L	U.Venta
69091	869,32	47x59,5	43,0	9,0	1

Chafing-Dish + Buffet
Chafing-Dish + Buffet



Cuerpo Chafing Dish GN 1/1 LUXE

Corps bain marie GN 1/1
Chafing Dish Körper, GN-Einsatz 1/1
GN 1/1 chafing dish body
Corpo chafing dish GN 1/1

Ref	€	cm	h (cm)	L	U.Venta
69099	699,48	59,5x47	25,0	9,0	1

Placa inducción con regulador

Plaque à induction avec regulateur
Induktionskochfeld mit regler
Round induction plate with power control
Placa de indução com regulador



Ref	€	W	cm	U.Venta
69131	97,94	1000	Ø24x8	1

Placa encastrable. Necesita agujero de Ø216 mm para introducir.
Encastrable plate. Need a Ø216 mm hole to insert the plate.

Aro complemento Chafing Dish

Support plaque induction
Zusatzring chafing-dish
Chafing-dish heater holder.
Aro complemento chafing dish



Ref	€	Ø (cm)	U.Venta
R690998	16,08	26	1



Soporte Chafing Dish GN 1/1 LUXE

Support Bain marie GN 1/1
Gestell für Chafing Dish 1/1
GN 1/1 chafing dish stand
Suporte chafing dish GN 1/1

Ref	€	cm	h (cm)	U.Venta
69089	169,84	41x55	17,0	1

Salsera Chafing Dish

Saucière chafing-dish Luxe.
Sauciere Chafing Dish, Luxe
Gravy spoon holder.
Molheira chafing dish



Ref	€	cm	h (cm)	L	U.Venta
R69099C	13,70	12x23	4,0	0,40	1



Chafing Dish GN 2/3 LUXE

Bain marie GN 2/3
Chafing Dish, GN-Einsatz 2/3
GN 2/3 chafing dish
Chafing dish GN 2/3

Ref	€	cm	h (cm)	L	U.Venta
69092	692,22	43x46	58,5	5,5	1



Cuerpo Chafing Dish GN 2/3 LUXE

Corps bain marie GN 2/3
Chafing Dish Körper, GN-Einsatz 2/3
GN 2/3 chafing dish body
Corpo chafing dish GN 2/3

Ref	€	cm	h (cm)	L	U.Venta
69095	546,76	46x43	25,5	5,5	1



Soporte Chafing Dish LUXE GN 2/3

Support Bain marie GN 2/3
Gestell für Chafing Dish 2/3
GN 2/3 chafing dish stand
Suporte chafing dish GN 2/3

Ref	€	cm	h (cm)	U.Venta
69087	145,46	40x37	17,0	1



Placa inducción con regulador

Plaque à induction avec régulateur
Induktionskochfeld mit regler
Round induction plate with power control
Placa de indução com regulador

Ref	€	W	cm	U.Venta
69131	97,94	1000	Ø24x8	1

Placa encastrable. Necesita agujero de Ø216 mm para introducirla.
Encastrable plate. Need a Ø216 mm hole to insert the plate.

Aro complemento Chafing Dish

Support plaque induction
Zusatzring chafing-dish
Chafing-dish heater holder
Aro complemento chafing dish

Ref	€	Ø (cm)	U.Venta
R690998	16,08	26	1



Salsera Chafing Dish

Saucière chafing-dish Luxe
Saucière Chafing Dish, Luxe
Gravy spoon holder
Molheira chafing dish

Ref	€	cm	h (cm)	L	U.Venta
R69099C	13,70	12x23	4,0	0,40	1





Chafing Dish GN 1/2 LUXE

Bain marie GN 1/2
Chafing Dish, GN-Einsatz 1/2
GN 1/2 chafing dish
Chafing dish GN 1/2 steel

Ref	€	cm	h (cm)	L	U.Venta
69093	623,85	32,5x46	44,5	4,0	1



Cuerpo Chafing Dish LUXE GN 1/2

Corps bain marie GN 1/2
Chafing Dish Körper, GN-Einsatz 1/2
GN 1/2 chafing dish body
Corpo chafing dish GN 1/2

Ref	€	cm	h (cm)	L	U.Venta
69094	503,81	46x32,5	25,5	4,0	1



Soporte Chafing Dish GN 1/2 LUXE

Support Bain marie GN 1/2
Gestell für Chafing Dish 1/2
GN 1/2 chafing dish stand
Suporte chafing dish GN 1/2

Ref	€	cm	h (cm)	U.Venta
69088	120,04	40x28	17,0	1



Placa inducción con regulador

Plaque à induction avec régulateur
Induktionskochfeld mit regler
Round induction plate with power control
Placa de indução com regulador

Ref	€	W	cm	U.Venta
69139	97,42	700	Ø18x8	1

Placa encastrable. Necesita agujero de Ø216 mm para introducirla.
Encastable plate. Need a Ø216 mm hole to insert the plate.



Aro complemento Chafing Dish

Support plaque induction
Zusatzring chafing-dish
Chafing-dish heater holder
Aro complemento chafing dish

Ref	€	Ø (cm)	U.Venta
R69094A	15,29	18	1

Salsera Chafing Dish

Sauciere chafing-dish Luxe
Sauciere Chafing Dish, Luxe
Gravy spoon holder
Molheira chafing dish



Ref	€	cm	h (cm)	L	U.Venta
R69099C	13,70	12x23	4,0	0,40	1



Chafing Dish SOPA LUXE

Bain marie soupiera
Suppen Chafing Dish
Soup chafing dish
Chafing dish sopa

Ref	€	Ø (cm)	h (cm)	L	U.Venta
69098	551,33	45	57,0	11,0	1



Cuerpo Chafing Dish SOPA LUXE

Corps bain marie soupiera
Suppen Chafing Dish Körper
Soup chafing dish body
Corpo chafing dish sopa

Ref	€	Ø (cm)	h (cm)	L	U.Venta
69100	405,14	45	38,0	11,0	1



Soporte Chafing Dish SOPA LUXE

Support bain marie soupiera
Gestell für Suppen Chafing Dish
Soup chafing dish stand
Suporte chafing dish sopa

Ref	€	cm	h (cm)	U.Venta
69097	145,18	41x32	17,0	1



Placa inducción con regulador

Plaque à induction avec régulateur
Induktionskochfeld mit regler
Round induction plate with power control
Placa de indução com regulador

Ref	€	W	cm	U.Venta
69131	97,94	1000	Ø24x8	1

Placa encastrable. Necesita agujero de Ø216 mm para introducirla.
Encastrable plate. Need a Ø216 mm hole to insert the plate.

Aro complemento Chafing Dish

Support plaque induction
Zusatzring chafing dish
Chafing-dish heater holder
Aro complemento chafing dish



Ref	€	Ø (cm)	U.Venta
R691008	16,60	27	1

Contenedor Chafing Dish LUXE SOPA

SOUPIERE Bain marie Luxe
Suppenbehälter chafing Dish, Luxe
Luxe soup container chafing dish
Recipiente chafing dish Luxe sopa



Ref	€	Ø (cm)	h (cm)	L	U.Venta
R69100A	21,58	29	22,0	11,0	1

Salsera Chafing Dish

Sauciere chafing-dish Luxe
Sauciere Chafing Dish, Luxe
Gravy spoon holder
Molheira chafing dish



Ref	€	cm	h (cm)	L	U.Venta
R69099C	13,70	12x23	4,0	0,40	1



Chafing Dish REDONDO LUXE

Bain marie ronde
Chafing Dish, rund
Round chafing dish
Chafing dish redondo steel

Ref	€	cm	h (cm)	L	U.Venta
69101	685,06	46,5x53	45,0	6,0	1



Cuerpo Chafing Dish REDONDO LUXE

Corps bain marie ronde
Chafing Dish Körper, rund
Round chafing dish body
Corpo chafing dish redondo

Ref	€	cm	h (cm)	L	U.Venta
69096	538,98	46,5x53	25,0	6,0	1



Soporte Chafing Dish SOPA LUXE

Support bain marie soupier
Gestel für Suppen Chafing Dish
Soup chafing dish stand
Suporte chafing dish sopa

Ref	€	cm	h (cm)	U.Venta
69097	145,18	41x32	17,0	1



Placa inducción con regulador

Plaque à induction avec régulateur
Induktionskochfeld mit regler
Round induction plate with power control
Placa de indução com regulador

Ref	€	W	cm	U.Venta
69131	97,94	1000	Ø24x8	1

Placa encastrable. Necesita agujero de Ø215 mm para introducirlo.
Encastrable plate. Need a Ø215 mm hole to insert the plate.



Fuente para Chafing Dish redondo

Plat rond pour Bain marie ronde
Einsatz für chafing-dish, rund
Food pan for round chafing-dish
travessa para chafing dish redondo

Ref	€	Ø (cm)	U.Venta
69019	51,05	35x7	1

Aro complemento Chafing Dish

Support plaque induction
Zusatzring chafing-dish
Chafing-dish heater holder
Aro complemento chafing dish

Ref	€	Ø (cm)	U.Venta
R691008	16,60	27	1



Sauciera Chafing Dish

Sauciere chafing-dish Luxe
Sauciere Chafing Dish, Luxe
Gravy spoon holder
Molheira chafing dish

Ref	€	cm	h (cm)	L	U.Venta
R69099C	13,70	12x23	4,0	0,40	1



▶ CHAFING DISH

Inox
18/10



Chafing Dish GN 1/1 Roll Top patas latón

Bain marie GN 1/1 roll top pieds en laiton
Chafing Dish, mit GN-Einsatz, Rolldeckel
Chafing dish GN 1/1 roll top brass legs
Chafing dish GN 1/1 roll top patas latão

Ref	€	cm	h (cm)	L	U.Venta
69015	548,85	53x32,5	6,50	9,0	1



Chafing Dish GN 1/1 Roll Top patas inox

Bain marie GN 1/1 roll top pieds en inox
Chafing Dish, mit GN-Einsatz, Rolldeckel
Chafing dish GN 1/1 roll top st. steel legs
Chafing dish GN 1/1 roll top patas inox

Ref	€	cm	h (cm)	L	U.Venta
69034	582,25	53x32,5	6,50	9,0	1



Chafing Dish Roll Top GN 1/1

Bain marie roll top GN 1/1
Chafing Dish, mit GN-Einsatz 1/1, Rolldeckel
Chafing dish roll GN 1/1
Chafing dish roll top GN 1/1

Ref	€	cm	h (cm)	L	U.Venta
69001	601,95	53x32,5	6,50	9,0	1



Chafing Dish Standard GN1/1

Bain marie standard GN 1/1
Chafing Dish Standard, mit GN-Einsatz 1/1
Chafing dish Standard GN 1/1
Chafing dish Standard GN 1/1

Ref	€	cm	h (cm)	L	U.Venta
69004	296,31	53x32,5	6,50	9,0	1

Cubeta interior (69185)
Inside container



Chafing Dish BASIC GN1/1 con tapa

Bain marie BASIC GN 1/1 avec couvercle en inox
Chafing Dish, BASIC, mit GN-Einsatz 1/1 mit Deckel, Rostfrei
BASIC Chafing Dish GN 1/1 with st. steel lid
Chafing Dish BASIC GN 1/1 com tampa en

Ref	€	cm	h (cm)	L	U.Venta
69110	92,13	56x35	28,0	8,5	1



96°C
max



92°C
max

Adapt. a Ref
69015 - 69001 - 69004 - 69110

Calentador eléctrico para Chafing

Corp de chauffe pour bain marie
Elektro-Heizung für Chafing Dish
Electric heating unit for chafing dish
Aquecedor eléctrico para chafing dish

Ref	€	W	U.Venta
A 69002	159,67	700	1
B 69012	184,68	700	1

Con regulador - With regulator

▶ CHAFING DISH ELÉCTRICO



Cubeta GN 1/1 en Inox (H=65 mm / 8,50 L)
GN 1/1 st steel container (H=65 mm / 8,5 L)

Tapa y cubeta en inox incluidas
Stainless steel lid and bucket included



Chafing Dish eléctrico

Chafing Dish électrique
Elektrische Chafing Dish
Electric Chafing Dish
Chafing Dish eléctrico

Ref	€	W	U. Venta
69336	153,79	900	1

Ref	Tensión/Voltage	Potencia/Power	Capacidad/Capacity	Temperatura/Temp.	Cubeta/Container	Dimensiones/Sizes	Peso/Weight
69336	220-240 V / 50-60 Hz	900 W	8,50 L	85°C (+/-10°C)	1GN 1/1 H=65 mm	55x34,5x25 cm	3,90 Kg



Ideal para el sector de la hostelería, restauración y catering.
Mantiene la temperatura de los alimentos.
Más seguro al carecer de llama de los geles.
Tapa y cubeta extraíble GN 1/1 H=65 mm (8,50 L) fabricados en acero inoxidable de alta calidad. Cuerpo fabricado en polipropileno.
Termostato regulable (85°C +/-10°C).
Interruptor de encendido y apagado. Indicador luminoso.
Protección contra sobrecalentamiento.
Fácil de transportar gracias a sus asas laterales.
6 pies antideslizantes y resistentes para mantener la estabilidad.

Parfait pour le secteur hôtelier, la restauration et le catering.
Conserve la température des aliments.
Plus sûr parce qu'il n'y a pas de flamme des gels.
Couvercle et bac amovible GN 1/1 H=65 mm (8,50 L) en acier inoxydable de haute qualité. Corps fabriqué en polypropylène.
Thermostat réglable (85°C +/- 10°C).
Interrupteur marche/arrêt. Indicateur lumineux.
Protection contre les surchauffes.
Facile à transporter grâce à ses poignées latérales.
6 pieds antidérapants et résistants pour maintenir la stabilité.

Ideal für Hotel- und Gaststättengewerbe und Catering.
Temperatur der Nahrungsmittel bleibt erhalten.
Sicherer ohne Brennpaste/Brenngel.
Abnehmbare Deckel und Speisensatz aus hochwertigem Edelstahl (GN 1/1 H=65 mm (8,50 l)). Mit Gestell aus Polypropylen.
Einstellbarer Thermostat (85°C +/-10°C).
Mit Ein- und Ausschalter. Kontrollleuchte.
Schutz vor Überhitzung.
Einfach an Seitengriffen zu tragen.
6 widerstandsfähige Anti-Rutschfüße für festen Stand.

Ideal for the hospitality, restaurant and catering sectors.
Maintains temperature of food.
Safer than chafing dishes that use gel fuels.
Removable lid and tray GN 1/1 H=65 mm (8,5 L) manufactured in high-quality stainless steel. Body manufactured in polypropylene.
Adjustable thermostat (85°C +/-10°C).
On / Off switch. Light indicator.
Overheating protection.
Easily portable using the side handles.
6 non-slip resistant bases to ensure stability.

Ideal para o setor da hotelaria, restauração e catering.
Mantém a temperatura dos alimentos.
Mais seguro, ao não utilizar géis com chama.
Tampa e coveira extraível de aço GN 1/1 H= 65 mm (8,50 L) de aço inoxidável de alta qualidade. Corpo fabricado em polipropileno.
Termostato regulável (85°C +/-10°C).
Interruptor de ligar/desligar. Indicador luminoso.
Proteção contra sobreaquecimento.
Fácil de transportar, graças às suas asas laterais.
6 patas antideslizantes e resistentes para maior estabilidade.

Combinaciones posibles de cubetas - Possible tray options



SERVIDORES · CALENTADORES

Inox
18/10



Servidor de zumos pie cromado

Distributeur de jus en inox
Saftbehälter mit rostfreiem Fuss
Juice dispenser mirror stand
Distribuidor de zumos pé cromado

Ref	€	L	U.Venta
69027	285,42	8,70	1
A R69018	24,80	Grifo	1
B R69027	81,65	Contenedor	1



Servidor de zumos

Distributeur de jus
Saftbehälter
Juice dispenser
Distribuidor de zumos

Ref	€	L	U.Venta
69018	285,42	8,70	1
A R69018	24,80	Grifo	1
B 69020	70,55	Contenedor	1



Calefador de líquidos BUFFET

Chauffe-café
Getränkbehalter
Coffee urn
Aquecedor de líquidos

Ref	€	L	U.Venta
69028	320,69	11,0	1
A R69018	24,80	Grifo	1

Inox

Contenedor de combustible

Porte-brûleur
Brennpasten-Behälter
Burner holder
Recipiente de combustible

Ref	€	Ø (cm)	h (cm)	Asa L. (cm)	U.Venta
69006	20,54	9,0	6,0	7,0	1



Gel de origen orgánico. No produce emanaciones tóxicas. Encendido rápido y combustión silenciosa, limpia, inodora, sin humos y sin cenizas.
Organic gel fuel. Does not produce toxic fumes. Quick-lighting and quiet-burning, clean, odourless, smokeless and ash-free.



Gel combustible ETANOL

Gel chauffe ETHANOL
Brennpaste, ETHYALKOHOL
Fuel gel, ETHANOL
Gel combustivel ETANOL

Ref	€	Kg	Horas	U.Venta
A 69108	2,28	0,225	3	72
B 69107	7,37	0,840	-	1
C 69109	33,93	4,00	-	1



AIRPOT



Fácil sist. de apertura
Easy open system



Nivel de indicador de líquido
Liquid level indicator



Sist. dispensador cómodo
Convenient dispensing system



Sensor de temperatura
Temperature sensor



Marcas de llenado
Fill lines



Posibilidad de graduar la temperatura
The temperature can be adjusted

Inox
18/10



Ideal para agua, café y té
Perfect for water, coffee and tea

Fabricado en acero inoxidable resistente y de alta calidad. Dispone de un grifo dispensador con indicador de nivel de líquido. Temperatura controlada por termostato con un rango de 60°C a 100°C. Dispone de asas laterales aislantes del calor para un desplazamiento seguro. NO USAR CON LÁCTEOS por la posible contaminación, debido a restos fermentados.

Fabricado en acier inoxydable résistant et de grande qualité. Dispose d'un robinet de distribution avec indicateur du niveau de liquide. Température contrôlée par thermostat dans une tranche de 60°C à 100°C. Dispose de poignées latérales isolantes de la chaleur pour un déplacement sûr. **NE PAS UTILISER DES PRODUITS LAITIERS** en raison de l'éventuelle contamination due aux résidus fermentés.

Aus widerstandsfähigem, hochwertigem Edelstahl hergestellt. Verfüg über einen Spenderhahn mit Flüssigkeitsfüllstandsanzeige. Temperaturegelung mithilfe eines Thermostats zwischen 60 und 100 °C. Mit seitlichen, wärmeisolierten Griffen für einen sicheren Transport. Von der Verwendung von MILCHPRODUKTEN wird wegen möglicher vorhandener vergäarter Reste **ABGERATEN**.

Made of strong high quality stainless steel. Includes a spigot with a level indicator. Temperature controlled by a thermostat with a range from 60° C to 100° C. Side mounted insulated handles for safe moving. **DO NOT USE WITH DAIRY PRODUCTS** due to possible contamination from fermented residue.

Fabricado em aço inoxidável resistente e de alta qualidade. Com torneira dispensadora com indicador de nível do líquido. Temperatura controlada por termostato regulável de 60 a 100° C. Dispõe de asas laterais isoladoras do calor para uma deslocação segura. **NÃO UTILIZAR COM LÁCTEOS** pela possível contaminação devido à existência de restos fermentados.



Airpot eléctrico

Électrique Airpot
Elektrische Getränkependler
Electric Airpot
Airpot eléctrico

Ref	€	L	U.Venta
69472	113,81	4	1
69476	122,94	6	1
69471	134,25	10	1

Ref	Tensión/Voltage	Potencia/Power	Capacidad/Capacity	Temperatura/Temp.	Dimensiones/Sizes	Peso/Weight
69472	220-240 V / 50-60 Hz	1500 W	4 L	60°C - 100°C	28x28x35 cm	1,90 Kg
69476	220-240 V / 50-60 Hz	1500 W	6 L	60°C - 100°C	28x28x40 cm	2,00 Kg
69471	220-240 V / 50-60 Hz	1500 W	10 L	60°C - 100°C	28x28x48 cm	2,20 Kg



Mantiene las bebidas calientes o frías durante 24 horas. Ligero e irrompible.

Boca ancha para cubos de hielo.

NO UTILIZAR CON BEBIDAS GASEOSAS NI LÁCTEOS.

Maintient les boissons chaudes ou froides pendant 24 heures.

Léger et incassable.

Bec large pour glaçons.

NE PAS UTILISER AVEC DES BOISSONS GAZEUSES NI DES PRODUITS LAITIERS.

Hält die Getränke 24 Stunden warm oder kalt.

Leicht und unzerbrechlich.

Breite Öffnung für Eiswürfel.

NICHT MIT GETRÄNKEN MIT KOHLENSÄURE ODER MILCHPRODUKTEN VERWENDEN.

Keeps drinks hot or cold for 24 hours.

Light and shatterproof.

Wide mouth for ice cubes.

Do NOT use with fizzy drinks or dairy.

Mantém as bebidas quentes e frias durante 24 horas.

Leve e inquebrável. Abertura larga para cubos de gelo.

NÃO UTILIZAR COM BEBIDAS GASOSAS NEM LÁCTEOS.

Inox
18/10

Air pot

Air pot
Getränkespender, isoliert
Air pot
Air pot

Ref	€	L	h (cm)	U.Venta
62472	58,83	2,50	32,5	1
62473	63,70	3,00	34,5	1
62475	85,49	4,00	39,0	1

DISPENSADORES



Ideal para diversos tipos de alimentos como cereales, copos de avena, copos de maíz, pasta, café, frutos secos, etc.
Higiénico y con gran capacidad de almacenamiento.
Montaje en la pared, aprovecha el espacio de tu mostrador o encimera (62541-62542)

Idéal pour différents types d'aliments tels que les céréales, les flocons d'avoine, les copieux de maïs, les pâtes, le café, les fruits secs, etc.
Hygénique et offrant une grande capacité.
Montage sur le mur, gain d'espace sur le comptoir ou le plan de travail (62541-62542)

Idéal für Frühstücklocken, Haferlocken, Corn Flakes, Pasta, Kaffee, Dörrobst und andere Arten von Lebensmittel.
Hygienisch und mit großer Fassungsvermögen.
Wandmontage – für mehr Platz auf Küchentheke oder Arbeitsfläche (62541-62542)

Ideal for various types of foods such as cereals, oatmeal, cornflakes, pasta, coffee, nuts, etc.
Hygienic and with a large storage capacity.
Wall mounted so you can make the most of your countertop or worktop space (62541-62542)

Idéal para diversos tipos de alimentos, como: cereais, flocos de aveia, flocos de milho, pasta, café, frutos secos, etc.
Higiénico e com grande capacidade de armazenamento.
Montagem na parede, para aproveitar o espaço do escaparate ou balcão (62541-62542)



Conserva la frescura y el sabor de los alimentos por más tiempo

Conserve la fraîcheur et le goût des aliments plus longtemps
 Sorgt für länger anhaltenden Geschmack und Frische der Nahrungsmittel
 Preserves the freshness and taste of food for longer
 Conserva a frescura e o sabor dos alimentos durante mais tempo



Sistema dispensador giratorio
 Rotating dispensing system

Base ancha, ofrece una mayor estabilidad
 Wide base for greater stability

Dispensador de cereales
 Distributeur de céréales
 Cerealdispenser
 Cereal dispenser
 Dispensador de cereais

Ref	€	cm	h (cm)	L	U.Venta
62545	19.40	16x20	40	3.50	1



Tapa hermética
 Lid hermetic

Sistema dispensador giratorio
 Rotating dispensing system

Dispensador de cereales de pared
 Distributeur de céréales mural
 Wandspender für Cerealien
 Wall-mounted cereal dispenser
 Dispensador de cereais de parede

Anclaje en pared
 Wall anchor

Ref	€	cm	h (cm)	L	U.Venta	
62541	13.49	14,5x12,5	31	1,50	1	Simple
62542	22.51	28x12,5	31	1,50 x 2	1	Doble Double



Inox
18/10

Dispensador de cereales con base

Distributeur de Cereales sur Pied
Cerialenspender mit Fuss
Cereal Dispenser with Stand
Distribuidor de cereis com base

	Ref	€	Ø (cm)	cm	L	U.Venta
A	69022	253,15	18,5	24x34x70	10,0	1
B	69023	501,42	18,5	44x34x70	10,0	1



Inox
18/10

Dispensador de leche

Dispensateur de lait en inox 18/10
Milchkanne mit Fuß, Roestfri: 18/10
St. steel 18/10 milk dispenser with base
Distribuidor de leite

	Ref	€	cm	L	U.Venta
	69030	375,58	22x33x44	5,5	1



ORGANIZADOR CAFÉ



Organizador de café

Organisateur de café
Kaffee Veranstalter
Coffee organizer
Organizador de café

	Ref	€	cm	h (cm)	U.Venta
A	62280	9,34	11,5x11,5	20	1
B	62281	33,82	35,5x26,5	18	1
C	62283	43,16	35,5x26,5	31	1

Conjunto - Set



ABS

plastic

New

Todo lo que necesitas para preparar un café. Todo en un solo lugar.
Cuenta con varios compartimentos, en los que podrás guardar vasos, azúcar, cápsulas, servilletas, etc.

Tout ce dont vous avez besoin pour préparer un café. Tout en un seul endroit.
Il dispose de plusieurs compartiments, dans lesquels vous pouvez stocker au
des verres, sucre, des capsules, des serviettes, etc.

Alles was Sie brauchen, um einen Kaffee zu machen. Alles an einem Ort.
Es hat mehrere Fächer, in denen Sie Gläser, Zucker, Kapseln, Servietten, usw.

Everything you need to make a coffee. All in one place.
It has several compartments, in which you can store glasses, sugar, capsules, napkins, etc.

Tudo que você precisa para fazer um café. Tudo em um só lugar.
Possui vários compartimentos, nos quais pode guardar copos, açúcar, cápsulas, guardanapos, etc.

▶ PLACAS DE INDUCCIÓN



Placas de inducción rápidas, eficaces, seguras, fiables y de gran capacidad de calentamiento.

Sus diseños portátiles y compactos resultan ideales para su uso en cualquier lugar.

Botones táctiles, intuitivos y fáciles de utilizar con un toque suave. 40% ahorro de tiempo y energía respecto a otras placas convencionales.

Plaque à induction rapide, efficace, sûre, fiable et d'une grande capacité de chauffe.

Sa conception portable et compacte est idéale pour une utilisation n'importe où.

Boutons tactiles, intuitifs et faciles à utiliser avec un toucher doux. 40% de gain de temps et d'économies d'énergie par rapport à d'autres plaques conventionnelles.

Schnelles, sicheres, zuverlässiges Induktionskochfeld mit hervorragender Heizleistung.

Aufgrund seines tragbaren und kompakten Designs ist es überall einsetzbar.

Intuitive, bodenereundliche Soft-Touch-Tastfelder. 40 % Zeit- und Energieersparnis verglichen mit anderen herkömmlichen Kochfeldern.

Fast, efficient, safe, reliable induction hob with high heating capacity. Its portable and compact design is ideal for use anywhere.

Intuitive and easy to use soft-touch buttons.

40% saving in time and energy compared to other conventional hobs.

Placa de indução rápida, eficaz, segura, fiável e de grande potência.

O seu design portátil e compacto permite a sua utilização em qualquer lugar.

Botões tácteis, intuitivos e fáceis de utilizar, com um suave toque.

Poupança de 40% em tempo e energia, em comparação com as placas convencionais.

Superficie de calentamiento
Heating surface

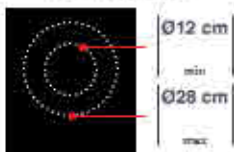

Superficie de calentamiento
Heating surface

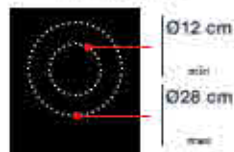

IPX3

proof

Placa Inducción Profesional

Plaque Induction Professionnelle

Profi-Induktionsplatte

Professional induction cooktop

Placa de Indução Profissional

Ref	€	W	U.Venta
69132	374.75	3500	1

Placa Inducción Profesional

Plaque Induction Professionnelle

Profi-Induktionsplatte

Professional induction cooktop

Placa de Indução Profissional

Ref	€	W	U.Venta
69337	316.85	2700	1

Ref	Tensión/Voltage	Potencia/Power	Niveles Pot. /P. levels	Temperatura/Temp.	Reloj/Timer	Dimensiones/Sizes	Peso/Weight
69132	220-240 V; 50/60 Hz	3500 W	17	35°C - 240°C	0 - 180 min	34x43x12 cm	7.35 Kg
69337	220-240 V; 50/60 Hz	2700 W	10	60°C - 240°C	0 - 180 min	30x39x10 cm	5.40 Kg

Superficie de calentamiento
Heating surface

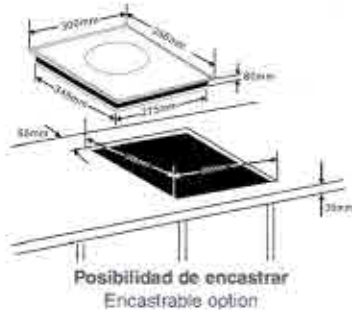
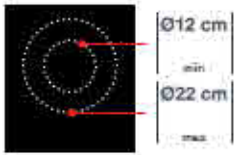

Posibilidad de encastrar
Encastrable option

Superficie de calentamiento
Heating surface

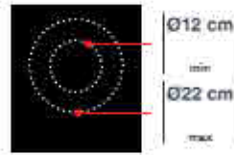

Placa de Inducción

Table de cuisine à induction
Induktionskochfeld
Induction Cooker
Placa de indução

Ref	€	W	U.Venta
69032	242,57	2000	1



Placa de Inducción SLIM

Table de cuisine à Induktion
Induktionskochfeld
Induction cooker
Placa de indução

Ref	€	W	U.Venta
69332	137,57	2000	1

Ref	Tensión/Voltage	Potencia/Power	Niveles Pot./P. levels	Reloj/Timer	Dimensiones/Sizes	Peso/Weight
69032	220-240 V, 50/60 Hz	2000 W	6	0 - 180 min	31x36x7,5 cm	2,90 Kg
69332	220-240 V, 50/60 Hz	2000 W	8	0 - 180 min	30x37x4,5 cm	2,67 Kg

Superficie de calentamiento
Heating surface

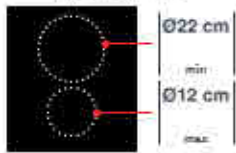

Posibilidad de encastrar
Encastrable option

Superficie de calentamiento
Heating surface

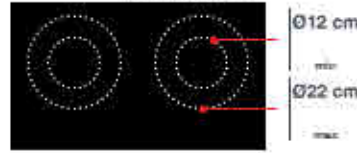

Posibilidad de encastrar
Encastrable option



Placa Inducción doble

Plaque induction double
Induktionskochfeld doppelt
Double induction cooktop
Placa de indução dupla

Ref	€	W	U.Venta
69033	397,16	1800+1300	1



Placa Inducción DUAL

Plaque induction
Induktionskochfeld doppelt
Induction cooktop
Placa de indução

Ref	€	W	U.Venta
69333	234,68	2000+1500	1

Ref	Tensión/Voltage	Potencia/Power	Niveles Pot./P. levels	Reloj/Timer	Dimensiones/Sizes	Peso/Weight
69033	220-240 V, 50/60 Hz	1800+1300 W	8	0 - 99 min	29x51x9 cm	4,50 Kg
69333	220-240 V, 50/60 Hz	2000 W + 1500 W	7	0 - 180 min	60x34x7,5 cm	5,20 Kg



Inox

Placa Inducción Wok Profesional

Plaque à induction wok Professionnelle
Induktionskochplatte Wok Professional
Induction cooktop wok Professional
Placa indução wok Profissional

Ref	€	U.Venta
69138	389,17	1

Cuerpo fabricado en 3 capas: acero inoxidable 18/10, aluminio, acero inoxidable 18%. La capa exterior, es de acero inoxidable con componentes ferríticos, lo que la convierte totalmente compatible con las cocinas de inducción. Los mango fabricado en acero inoxidable 18/10 y recubierto con un protector térmico de silicona

Body manufactured in a 3-layered: 18/19 stainless steel, aluminium, 18% stainless steel. Exterior layer of stainless steel with ferrite materials, making it completely compatible with induction cookers. The grip are made in 18/10 stainless steel and covered in a silicon heat protection.



Wok Trimetal

Wok Trimetal
Wok, Trimetal
Trimetal wok
Wok Trimetal

Ref	€	Ø (cm)	L
53836	151,48	36	5,50



Ref	Tensión/Voltage	Potencia/Power	Temperatura/Temp	Tiempo/Timer	Dimensiones/Sizes	Peso/Weight
69138	220-240 V, 50/60 Hz	3500 W	60°C - 240°C	0- 180 min	34x44,5x12,5 cm	7,50 Kg

▶ PLACA VITROCERÁMICA

Superficie de calentamiento
Heating surface

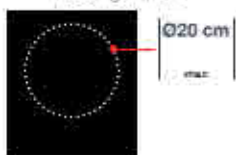

Household use

Placa vitrocerámica VITRO

Plaque vitrocéramique
Keramikkochfeld
Ceramic hob
Placa vitrocerámica

Ref	€	W	U.Venta
69232	97,63	2000	1



Placa vitrocerámica rápida, eficaz, segura, fiable y de gran capacidad de calentamiento.

Su diseño portátil y compacto resulta ideal para su uso en cualquier lugar. Botones táctiles, intuitivos y fáciles de utilizar con un toque suave. Indicadores luminosos. Regulable en potencia y temperatura. Temporizador de 240 minutos con avisador acústico y auto desconexión. Dispone de función de bloqueo de seguridad para niños.

Plaque vitrocéramique rapide, efficace, sûre, fiable et d'une grande capacité de chauffe. Sa conception portable et compacte est idéale pour une utilisation n'importe où. Boutons tactiles, intuitifs et faciles à utiliser avec un toucher doux. Indicateurs lumineux. Réglable en puissance et en température. Minuteur de 240 minutes avec alerte sonore et arrêt automatique. Dispose d'une fonction de blocage de sécurité pour les enfants.

Schnelles, sicheres, zuverlässiges Keramikkochfeld mit hervorragender Heizleistung. Aufgrund seines tragbaren und kompakten Designs ist es überall einsetzbar. Intuitive, bedienerfreundliche Soft-Touch-Tastfelder. Leuchtanzeigen. Regulierbare Leistung und Temperatur. Zeitschaltuhr bis 240 Minuten mit akustischem Warnsignal und automatischer Abschaltung. Kindersicherungsfunktion.

Fast, efficient, safe, reliable ceramic hob with high heating capacity. Its portable and compact design is ideal for use anywhere. Intuitive and easy to use soft touch buttons. Luminous indicators. Adjustable power and temperature. 240 minute timer with audible warning and auto-off. Includes a child safety lock function.

Placa vitrocerámica rápida, eficaz, segura, fiable e de grande potência. O seu design portátil e compacto permite a sua utilização em qualquer lugar. Botões tácteis, intuitivos e fáceis de utilizar, com um suave toque. Indicadores luminosos. Potência e temperatura reguláveis. Temporizador de 240 minutos com avisador acústico e desconexão automática. Função de bloqueio de segurança à prova de crianças.



Ref	Tensión/Voltage	Potencia/Power	Temperatura/Temp.	Temporizador/Timer	Ø cocción/Cooking Ø	Dimensiones/Sizes	Peso/Weight
69232	220-240 V, 50/60 Hz	2000 W (8 levels)	60°C - 600°C (8 levels)	0 - 240 min (8 levels)	10 cm / 20 cm	39x32x5,5 cm	2,60 Kg

▶ PLACAS CALENTAMIENTO



Calentador BUFFET 3x GN 1/3

Chauffe
Warmer
Warmer
Aquecedor

Ref	€	W	U.Venta
69445	24,87	300	1



Placa calentamiento

Plaque pour Chauffants
Warmhalteplatte
Warming Plate
Placa aquecimento

Ref	€	W	U.Venta
69045	80,41	300	1



Placa calentamiento Vitrocéramica

Plaque vitrocéramique chaleur
Glaskeramikheizplatte
Hob heating plate
Placa aquecimento vitrocéramica

Ref	€	W	U.Venta
69145	177,83	230	1



Platos y bandejas siempre calientes

Ensures dishes and trays are always warm

Una solución perfecta para profesionales de hostelería, buffet, eventos, catering, ferias...
Ideal para mantener los alimentos calientes antes de servirlos en la mesa a una temperatura perfecta.
Termostato regulable en temperatura.
Tres contenedores de calentamiento GN 1/3 de 2.5 L con tapas transparentes de policarbonato, ideales para albergar una gran variedad de alimentos.
Marco soporte de acero inoxidable (Ref.: 69445).
Puede usarlo como placa de calentamiento para calentar platos y preparados, quitando el soporte y los contenedores (Ref.: 69445).
NO cocinar sobre la misma placa. Asas aislantes de calor y patas antideslizantes.

Une solution parfaite pour les professionnels de l'hôtellerie, buffets, événements, traiteurs, salons...
Idéale pour garder au chaud d'aliments avant de les servir à table à une température parfaite.
Thermostat réglable en température.
Trois conteneurs de réchauffage (GN 1/3 ou 2.5 L avec couvercles transparents en polycarbonate), parfaits pour accueillir une grande variété d'aliments. Cadre support en acier inoxydable (Ref.: 69445).
Peut être utilisé en tant que plaque pour réchauffer des plats et des préparations culinaires, en retirant le support et les conteneurs (Ref.: 69445).
NE PAS cuisiner sur la même plaque. Poignées isolantes de la chaleur et pieds antidérapants.

Die perfekte Lösung für Gastgewerbe, Buffets, Veranstaltungen, Catering, Messen...
Ideal zum Warmhalten von Speisen, bevor sie bei perfekter Temperatur am Tisch serviert werden.
Thermostat mit Temperaturregelung.
Drei Heizbehälter GN 1/3 mit einem Volumen von 2,5 l und durchsichtigen Polycarbonat-Decke, ideal zum Aufbewahren vielfältiger Lebensmittel.
Trägerrahmen aus Edelstahl (Ref.: 69445).
Kann bei Entfernern des Halters und der Behälter als Heizplatte zum Erwärmen von Speisen und Fertiggerichten verwendet werden (Ref.: 69445).
NICHT direkt auf der Platte kochen. Isolierte Griffe und rutschfeste Füße.

A perfect solution for hospitality, buffet, events, catering and trade show professionals...
Ideal for keeping the food warm before serving them at a perfect temperature.
Temperature-adjustable thermostat.
Three GN 1/3 2.5 L heating containers with transparent polycarbonate lids, perfect for storing a wide variety of food. Stainless steel support frame (Ref.: 69445).
It can be used as a heating plate to warm up food or prepared dishes if the support and the containers are taken off (Ref.: 69445).
DO NOT cook on the same tray. Heat-insulating handles and non-slip feet.

Uma solução perfeita para profissões de hotelaria, buffets, eventos, catering, feiras...
Ideal para manter quentes os alimentos, para os servir à mesa a uma temperatura perfeita.
Termostato de temperatura regulável.
Três recipientes de aquecimento GN 1/3 de 2,5 litros, com tampas transparentes de policarbonato, ideais para armazenar uma grande variedade de alimentos.
Marco de suporte em aço inoxidável (Ref.: 69445).
Pode utilizar-se como placa de aquecimento para aquecer pratos e preparados, retirando o suporte e os recipientes (Ref.: 69445).
NÃO cozinhar na própria placa. Asas isoladoras do calor e patas antidesslizantes.

Ref	Tensión/Voltage	Potencia/Power	Contenedor/Container	Temp. máx./ Max. temp.	Placa/Plate	Dimensiones/Sizes	Peso/Weight
69445	220-240 V, 50/60 Hz	300 W	GN 1/3 - 2.5 L (3)	80°C (max)	53x35,8 cm	65x38x15,4 cm	4,20 Kg
69045	220-240 V, 50/60 Hz	300 W	-	80°C (max)	53x35,5 cm	65x38x6,2 cm	2,60 Kg
69145	220-240 V, 50/60 Hz	230 W	-	105°C (max)	55x36,5 cm	62x36,5x4,5 cm	4,10 Kg

▶ CALENTADORES



Mantiene caliente todo tipo de sopas, salsas, consomés y líquidos. Ideal para cantidades grandes.

Maintenir au chaud tout type de soupes, sauces, consommés, liquides, etc. Idéal pour de grandes quantités.

Warmhalten aller Arten von Suppen, Saucen, Konsommées, Flüssigkeiten, usw. Ideal für große Mengen.

Keep all kinds of soups, sauces, consommés, liquids etc hot. Ideal for large amounts.

Mantem quente todo o tipo de sopas, molhos, consomés, líquidos, etc. Ideal para grandes quantidades.

Inox
18/10

Calentador de sopa

Chaufte-soupe
Suppenwärmer
Soup heater
Aquecedor de sopa



Ref	€	U.Venta
69257	254,08	1

Olla calentador sopa

Marmite Buffet chaud
Suppen- und Speisenwärmer
Soup kettle
Panela aquecedora de sopa



Ref	€	U.Venta	
69037	149,51	1	Hierro esmaltado
69038	214,87	1	Inox



Inox
18/10

Contenedor sopa Inox 10 L

Bac pour soup en inox
Behälter für elektrischen Wärmer
St. Steel soup container
Recipiente sopa Inox 10 L



Ref	€	Ø (cm)	L
69039	50,01	24x25	10

Ref	Tensión/Voltage	Potencia/Power	Temperatura/Temp.	Capacidad/Capacity	Dimensiones/Sizes	Peso/Weight
69267	220-240 V, 50/60 Hz	800 W	30°C - 90°C	11,0 L	Ø33x32 cm	4,50 Kg
69037	220-240 V, 50/60 Hz	400 - 475 W	30°C - 90°C	10,0 L	Ø34,5x36 cm	4,50 Kg
69038	220-240 V, 50/60 Hz	400 - 475 W	30°C - 90°C	10,0 L	Ø34,5x36 cm	4,50 Kg

Inox
18/10

Fuente de chocolate

Fontaine chocolat
Schokoladen Fontäne
Chocolate fountain
Fonte chocolate

	Ref	€	Torre	U.Venta
A	69318	52,50	18 cm	1
B	69319	87,88	38 cm	1



Ref	Tensión/Voltage	Potencia/Power	Temperatura/Temp.	Capacidad/Capacity	Torre/Tower	Dimensiones/Sizes	Peso/Weight
69318	220-240 V, 50/60 Hz	35 W	40 - 50°C	0,50 L (max)	18 cms (Height)	Ø16x30 cm	1,15 Kg
69319	220-240 V, 50/60 Hz	80 W	40 - 50°C	1,80 L (max)	38 cms (Height)	Ø23x54,5 cm	2,05 Kg

▶ CALENTADOR BUFFET



Incluye bombillas infrarrojos (Ref.: R69061A)
Includes infrared heating bulbs



Calentador BUFFET DUAL

Plaque électrique
Warmhalteplatte
Electric warming plate
Placa aquecimento elétrico

Ref	€	W (Placa)	W (Lámp.)	U.Venta
69562	442,29	500	2 x 250	1



Ideal para grandes cocinas, buffet, catering o comedores.
Mantiene los platos a temperatura perfecta durante un tiempo prolongado.
Estructura de acero inoxidable de alta calidad y resistente.
Placa calentadora de acero inoxidable con regulación de temperatura entre 40°C - 90°C.
Lámparas halógenas para garantizar una temperatura homogénea con regulación independiente para cada una de ellas.
Pantalla protectora de plexiglás altamente resistente.

Idéal pour grandes cuisines, buffets, traiteurs ou commerces
Maintient les plats à la température parfaite pendant un laps de temps prolongé
Structure en acier inoxydable de grande qualité et résistante
Plaque chauffante en acier inoxydable avec réglage de température de 40°C à 90°C
Ampoules halogènes pour garantir une température homogène avec réglage indépendant pour chacune d'entre elles
Écran de protection en plexiglas hautement résistant

Ideal für Großküchen, Buffets, Catering oder Restaurants.
Hält Speisen über längere Zeit auf perfekter Temperatur
Aus hochwertigem und widerstandsfähigem Edelstahl hergestellter Aufbau
Heizplatte aus Edelstahl mit Temperaturreglung zwischen 40°C bis 90°C
Individuell einstellbare Halogenlampen sorgen für gleich bleibende Temperatur
Schutzschirm aus hoch widerstandsfähigem Plexiglas

Perfect for large kitchens, buffets, catering or dining rooms
It keeps food at the perfect temperature for an extended period
Durable high quality stainless steel structure
Stainless steel heating plate with adjustable temperature from 40° C to 90° C
The halogen lamps guarantee even temperature and each one can be adjusted independently
High impact perspex safety screen

Ideal para cozinhas grandes, buffets, catering e restaurantes.
Mantém os pratos à temperatura perfeita durante um tempo prolongado
Estrutura de aço inoxidável de alta qualidade e resistente
Placa aquecedora em aço inoxidável com regulação de temperatura entre 40 - 90 °C
Lâmpadas de halógeno para garantir uma temperatura homogênea, com regulação individual e independente
Placa protetora de metacrilato, altamente resistente



Calentador BUFFET TRIPLE

Plaque électrique
Warmhalteplatte
Electric warming plate
Placa aquecimento elétrico

Ref	€	W (Placa)	W (Lámp.)	U.Venta
69563	582,87	650	3 x 250	1

Ref	Tensión/Voltage	Pot. Placa/Plate P.	Nº Lámp./Lamps	Pot. Lámp./Lamp P.	Temperatura/Temp.	Dimensiones/Sizes	Peso/Weight
69562	220-240 V; 50/60 Hz	500 W	2	250 W	40°C - 90°C	78x53x70 cm	12,5 Kg
69563	220-240 V; 50/60 Hz	650 W	3	250 W	40°C - 90°C	107x53x70 cm	16,5 Kg

▶ LÁMPARAS CALENTAMIENTO

Apta para todas nuestras lámparas de calentamiento
Suitable for all our heating lamps

Bombilla infrarrojos

Ampoule infrarouge
Infrarot Glühbirne
Infrared heating bulb
Lampada infravermelho

Ref	€	W	U.Venta
R69061A	8,40	275	1



Para uso profesional en hostelería.

Mantiene calientes los platos. Calentamiento por infrarrojos.

Se aconseja mantener la lámpara a 50 - 60 cm de distancia de los platos.

Bombilla para todas nuestras lámparas de calentamiento.

Pour un usage professionnel en hôtellerie

Maintient les plats au chaud. Chauffage par infrarouges

Il est conseillé de maintenir la lampe à une distance de 50 - 60 cm des plats.

Ampoule pour toutes nos lampes chauffantes.

Für den Einsatz im Gastronomiebereich.

Hält die Speisen warm: Erwärmung durch Infrarotstrahlen

Es wird empfohlen, einen Abstand von 50 bis 60 cm zwischen der Lampe und den Speisen einzuhalten.

Glühbirne für alle unsere Heizlampen.

For professional catering use

Hält die Speisen warm: Infrared heating.

It is recommended that the lamp is kept at a distance of 50-60cm from the plates.

Bulb for all our heating lamps.

Para uso profissional em hôtalaria

Mantém os pratos quentes: Aquecimento por infravermelhos

É recomendável manter as lâmpadas a uma distância de 50 a 60 cm dos pratos.

Bulbo para todas as nossas lâmpadas de aquecimento.

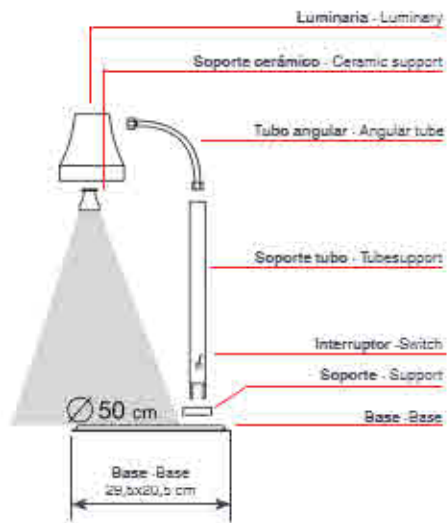

Incluye bombillas infrarrojos (Ref.: R69061A)
Includes infrared heating bulbs.



AL
Aluminium

Lámpara calentamiento infrarrojos

Lampe de chauffage infrarouge
Infrarot Wärmelampe
Infrared heating lamp
Lampara calor infravermelho

Ref	€	W	U.Venta
A 69361	90,37	275	1
B 69061	125,12	550	1



Regulable en altura
Height adjustable.



Inox
18/10

Lámpara de calentamiento infrarrojos

Lampe de chauffage infrarouge
Infrarot Wärmelampe
Infrared heating lamp
Lampara calor infravermelho

Ref	€	W	U.Venta
A 69263	407,32	275	1
B 69264	529,44	550	1

Ref	Tensión/Voltage	Potencia/Power	Dimensiones/Sizes	Peso/Weight
69361	220-240 V; 50/60 Hz	275 W	34x33x56 - 71 cm	1,15 Kg
69061	220-240 V; 50/60 Hz	550 W	36x45x61 - 75 cm	1,58 Kg
69263	220-240 V; 50/60 Hz	275 W	79x31x23 cm	6,0 Kg
69264	220-240 V; 50/60 Hz	550 W	76x36x36 cm	7,0 Kg

▶ LÁMPARAS CALENTAMIENTO EXTENSIBLES

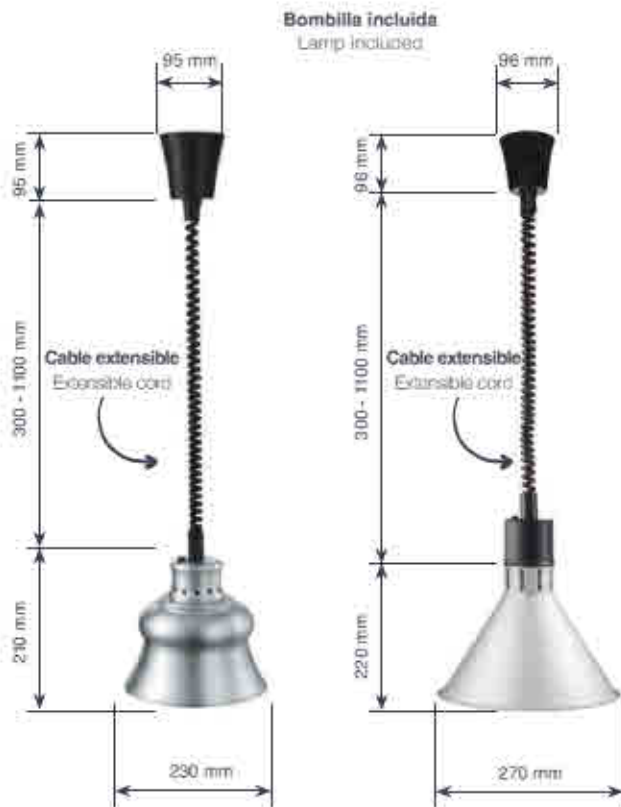

Para uso profesional en hostelería.
Mantiene calientes los platos. Calentamiento por infrarrojos.
Se aconseja mantener la lámpara a 50 - 60 cm de distancia de los platos.
Bombilla para todas nuestras lámparas de calentamiento.

Pour un usage professionnel en hôtellerie
 Maintient les plats au chaud. Chauffage par infrarouges.
 Il est conseillé de maintenir la lampe à une distance de 50 - 60 cm des plats.
 Ampoule pour toutes nos lampes chauffantes.

Für den Einsatz im Gastronomiebereich.
 Hält die Speisen warm. Erwärmung durch Infrarotstrahlen.
 Es wird empfohlen, einen Abstand von 50 bis 60 cm zwischen der Lampe und den Speisen einzuhalten.
 Glühbirne für alle unsere Heizlampen.

For professional catering use.
 Keeps the dishes warm. Infrared heating.
 It is recommended that the lamp is kept at a distance of 50-60cm from the plates.
 Bulb for all our heating lamps.

Para uso profesional em hôtalaria
 Mantém os pratos quentes. Aquecimento por infravermelhos.
 É recomendável manter as lâmpadas a uma distância de 50 a 60 cm dos pratos.
 Bulbo para todas as nossas lâmpadas de aquecimento.



Incluye bombillas infrarrojos (Ref.: R69061A)
 Includes infrared heating bulbs.



Lámpara de calentamiento infrarrojos cable extensible

Lampe de chauffage infrarouge câble extensible.
 Infrarot Wärmelampe Kabel ausziehbar.
 Infrared heating lamp extensible.
 Lâmpara calor infravermelho cabo extensível.

	Ref	€	W	U.Venta	
A	69266	109,23	275	1	Lijado / Sanding
B	69365	118,69	275	1	Cromado / Chrome
C	69367	118,69	275	1	Cobre / Copper



Lámpara de calentamiento extensible cónica

Lampe chauffante extensible conique.
 Wärmelampe Kabel ausziehbar, konisch.
 Conical heating lamp extensible.
 Lâmpada de aquecimento ext. cônica.

	Ref	€	W	U.Venta	
A	69564	106,97	275	1	Lijado / Sanding
B	69566	128,34	275	1	Cromado / Chrome
C	69565	130,52	275	1	Cobre / Copper

Ref	Tensión/Voltage	Potencia/Power	Dist. lámp. alimentos / Lamp food distance	Peso/Weight
69266	220-240 V; 50/60 Hz	275 W	50 - 60 cm	2,00 Kg
69365	220-240 V; 50/60 Hz	275 W	50 - 60 cm	2,00 Kg
69367	220-240 V; 50/60 Hz	275 W	50 - 60 cm	2,00 Kg
69564	220-240 V; 50/60 Hz	275 W	50 - 60 cm	1,60 Kg
69566	220-240 V; 50/60 Hz	275 W	50 - 60 cm	1,60 Kg
69565	220-240 V; 50/60 Hz	275 W	50 - 60 cm	1,60 Kg

▶ FRUTEROS · PANERAS



FE

Steel

Originales fruteros muy decorativos fabricados en alambre de acero, acabado en negro mate. Resistentes y duraderos. Se pueden usar para almacenar fruta, pan, verduras, huevos, etc.

Corbeilles à fruits originales et très décoratives fabriquées en fil d'acier avec une finition noire mate. Résistantes et durables. Peuvent être utilisées pour y déposer des fruits, du pain, des légumes, des œufs, etc.

Originelle und sehr dekorative Drahtkörbe aus Stahl Draht mit matschwarzer Oberfläche. Haltbar und strapazierfähig. Körbe zum Aufbewahren von Obst, Brot, Gemüse, Eiern usw.

Highly decorative original fruit bowls made of steel wire with a matte black finish. Resistant and durable. Can be used for storing fruit, bread, vegetables, eggs, etc.

Originales fruteros decorativos fabricados em arame de aço. Acabamento preto mate. Resistentes e duráveis. Para armazenar fruta, pão, verduras, ovos, etc.

C



Frutero varillas

Corbeille à fruits
Obetschale aus Gitterstäben
Rod fruit bowl
Cesto de metal para fruta

	Ref.	€	Ø (cm)	h (cm)	ØVarilla (mm)	U.Venta
A	61126	19.40	23,4	25,4	4	2
B	61127	17.53	27,0	13,8	4	1
C	61128	18.57	34,0	9,5	4	1

B



A



Madera contrachapada color haya
Plywood beech color



Frutero varillas

Corbeille à fruits
Obetschale aus Gitterstäben
Square fruit bowl
Cesto de metal para fruta

	Ref.	€	Cesta (cm)	h Total (cm)	ØVarilla (mm)	U.Venta
A	61137	29.05	26x26x18.3	27,8	4	1
B	61138	29.05	Ø25.2x17.7	28,9	4	1

Madera
Agglomerada
Agglomerada
Wood



Frutero varillas redondo bajo

Corbeille à fruits ronde basse
Obetschale aus Gitterstäben
Round low rod fruit bowl
Cesto de metal para fruta redondo baixo

	Ref.	€	Cesta (cm)	h (cm)	Ø Base (mm)	ØVarilla (mm)	U.Venta
	61139	33.51	Ø39x6	7,6	31,3	4	1

Madera
Caucho
Rubber Wood

Frutero varillas DUAL

Corbeille à fruits
Obetschale aus Gitterstäben
Rod fruit bowl
Cesto de metal para fruta



Ref	€	Grande (cm)	Peq. (cm)	h (cm)	ØVarilla (mm)	U.Venta
61140	45,13	Ø40x10	Ø24x10	63	4	1

Inox

Panera abatible

Paniere rabattabile
Abfallen Brotkorb
Bread bin foldable lid
Cestonreclinável



Ref	€	cm	h (cm)	U.Venta
62944	35,07	44x29	19	1



Panera Marrón NATURA

Corbeille à pain en marron
Brotbeutel, braun
Brown bread basket
Cesto para o pão de Castanho

	Ref	€	cm	h max (cm)	h min (cm)	U.Venta
A	63476	11,93	10x10	25	8	1
B	63477	12,66	12x12	25	12	1
C	63478	14,32	15x15	25	12	1
D	63479	16,50	20x20	33	12	1



Fabricadas en fibra virgen natural.
Material ecológico y respetuoso con el medio ambiente.
Lavables, resistentes y duraderas.
Diseñadas y fabricadas en España.
Hechas a mano.
Tacto agradable y suave, similar a la piel.
Espesor 0,55 mm.

Fabricadas em fibras virgens naturais.
Material ecológico e respeitador do meio ambiente.
Laváveis, resistentes e duráveis.
Confeitas e fabricadas em Espanha.
Feitas à mão.
Tacto agradável e suave, similar ao couro.
Espessura de 0,55 mm.

Aus natürlicher Faser.
Umweltverträgliches Öko-Material.
Waschbar, robust und langlebig.
Design und Herstellung in Spanien.
Handgefertigt.
Weich und angenehm wie Leder.
0,55 mm dick.

Made of natural virgin fibre.
Ecological material respectful with the environment.
Washable, resistant and durable.
Designed and manufactured in Spain.
Handmade.
Nice soft feel, similar to leather.
Thickness 0.55 mm.

Fabricados em fibra virgen natural.
Material ecológico, respetuoso do meio ambiente.
Laváveis, resistentes e duráveis.
Desenhados e fabricados em Espanha.
Fabricados à mão.
Tato agradável e suave, similar ao do couro.
Espessura 0,55 mm.



Panera Negra NATURA

Corbeille à pain en noire
Brotbeutel, schwarz
Black bread basket
Cesto para o pão de Preto

	Ref	€	cm	h max (cm)	h min (cm)	U.Venta
A	63486	11,93	10x10	25	8	1
B	63487	12,66	12x12	25	12	1
C	63488	14,32	15x15	25	12	1
D	63489	16,50	20x20	33	12	1



Cesta de pan redonda

Corbeille à pain ronde
Brotkorb, rund
Round bread basket
Cesta de pão redonda

A		B				
Ref	€	Ref	€	Ø (cm)	h (cm)	U.Venta
63471	6,64	63871	6,74	19	8	1
63472	7,37	63872	7,37	21	8	1
63473	7,89	63873	7,89	23	8	1
63474	8,40	63874	8,51	26	8	1



Diseñadas para uso intensivo.
Elaboradas a mano.
Acabado en mate.
Alta resistencia y durabilidad.
Apilables.

Conçu pour une utilisation intensive.
Fait à la main.
Fini mat.
Haute résistance et la durabilité.
Empilable.

Auswahl für den intensiven Gebrauch.
Handgemacht.
Matte Oberfläche-entwickelt.
Hohe Festigkeit und Haltbarkeit.
Sapelbar.

Designed for intensive use.
Handmade.
Matte finish.
High strength and durability.
Stackable.

Projado para uso intensivo.
Feito à mão.
Acabamento fosco.
Alta resistência e durabilidade.
Ampliável.



Cesta de pan oval

Corbeille à pain ovale
Brotkorb, Oval
Oval bread basket
Cesta de pão oval

A		B				
Ref	€	Ref	€	cm	h (cm)	U.Venta
63480	5,02	63880	5,02	19x14	8,0	1
63481	7,16	63881	7,06	24x17	8,0	1
63482	8,72	63882	8,72	28x16	8,5	1



Cesta de pan

Corbeille à pain
Crotkorb
Bread basket
Cesta de pão

A		B		
Ref	€	Ref	€	U.Venta
63494	25,73	63894	25,40	35x20

Cesta de pan cuadrada

Corbeille à pain carré
Crotkorb, vierkig
Square bread basket
Cesta de pão quadrada

A		B			
Ref	€	Ref	€	cm	U.Venta
63490	29,57	63890	29,26	53x33,5x9	1

TOSTADORAS



Tostado continuo de pan
Continuous bread toasting



Tostadora de cinta transportadora

Toasteur professionnel
Durchlauf/toaster
Conveyor toaster
Torradeira de tapete rolante

Ref	€	W	U.Venta
69065	719.09	1340	1
69066	829.38	2240	1

Hueco útil entre parrillas 5,5 cm
Usable gap between racks 5.5 cm



Bandeja recogemigas
Crumbs tray



Tostador horizontal

Grille-pain horizontal
Toaster horizontal
Horizontal toaster
Torradeira horizontal

Ref	€	W	U.Venta
A 69172	301.81	2400	1
B 69173	360.32	3150	1

Ref	Tensión/Voltage	Potencia/Power	Velocidad/Speed	Producción/Product.	Lámp./Lamps	Parrilla/Grill	Dimensiones/Sizes	Peso/Weight
69065	220-240 V; 50 Hz	1340 W	0,46 - 0,73 m/min.	150 h	-	-	53x37x40 cm	12,65 Kg
69066	220-240 V; 50 Hz	2240 W	0,46 - 0,73 m/min.	300 h	-	-	53x45x40 cm	15,50 Kg
69172	220-240 V; 50/60 Hz	2400 W	-	-	6 (3 + 3)	40x24 cm	50x25x28 cm	7,10 Kg
69173	220-240 V; 50/60 Hz	3150 W	-	-	9 (3 + 3 + 3)	40x24 cm	50x25x38cm	9,20 Kg



Ranuras de grandes
dimensiones

Huge slots for toasting

Bandeja recogemigas
Crumbs tray



Tostadora Buffet Inox 4-6 ranuras

Grille-pain buffet pour 4-6 tranches
Buffet-Toaster für 4-6 Brötscheiben
4-6 slots st steel buffet toaster
Torradeira buffet 4-6 fatias de pão

Ref	€	Ranuras	U.Venta
69294	198.47	4	1
69296	263.63	6	1



Inox

Tostadora LUXE para 2-4 ranuras

Grille-pain LUXE pour 2-4 tranches
LUXE-Toaster für 2-4 Brötscheiben
LUXE 2-4 slots toaster
Torradeira LUXE para 2-4 fatias de pão

Ref	€	W	U.Venta
69164	90.16	1400	1

Ref	Tensión/Voltage	Potencia/Power	Selector/Selector	Ranuras/Slots	Dimensiones/Sizes	Peso/Weight
69294	220-240 V; 50/60 Hz	1800 W	2-4 ranuras - 2-4 groves	15x3 cm	37x21x22 cm	4,80 Kg
69296	220-240 V; 50/60 Hz	2500 W	2-4 6 ranuras - 2-4 6 groves	15x3 cm	46x22,5x22 cm	6,00 Kg
69164	220-240 V; 50/60 Hz	1400 W	2-4 ranuras - 2-4 grove	14x4 cm	32x26x19 cm	2,70 Kg



Gracias a su diseño y área de calentamiento podrá tostar todo tipo de panes o bollería y varias rebanadas a la vez.

Grâce à sa conception et sa zone de chauffe, vous pourrez griller tout type de pains ou de viennoiseries et plusieurs tranches à la fois.

Dank des Designs und des Erwärmungsbereichs können Sie alle möglichen Brotsorten und mehrere Scheiben gleichzeitig tosten.

Thanks to its design and heating area you will be able to toast all types of bread and pastries, and several slices at a time.

Gracias ao seu deseño e área de aquecemento, poderá tostar todo o tipo de pães ou bolos, e varias fatias ao mesmo tempo.



6 posiciones de calentamiento
6 heating positions



Aviso sonoro
Alarm



Bandeja recogemigas
Crumb tray

Tostadora horizontal

Toaster horizontal
Horizontal/Toaster
Electric toaster
Torradeira horizontal

	Ref	€	W	U.Venta
A	69163	28,43	600	1
B	69363	35,59	600	1

Ref	Tensión/Voltage	Potencia/Power	Temperatura/Temp.	Tostado/Toasted	Parrilla/Grill	Dimensiones/Sizes	Peso/Weight
69163	220-240 V, 50/60 Hz	600 W	360 °C	6	25x20 cm	36x21 x6,5 cm	1,00 Kg
69363	220-240 V, 50/60 Hz	600 W	360 °C	6	25x20 cm	42x30x9 cm	1,00 Kg

▶ TOSTADORAS RANURA LARGA



Permite tostar de forma rápida y sencilla, sin necesidad de añadir grasa alguna.
Función de descongelación y cancelación.
 Regulador ajustable de tueste, elige entre 7 niveles para tostar a tu gusto.
Ranura alargada para rebanadas extra largas o para más de una rebanada de pan.
Parrilla adicional para calentar bollos o pan (69360).
Incorpora una práctica bandeja, donde se depositan las migas.

Permet de griller de façon rapide et simple sans nécessité d'ajouter aucune graisse.
 Fonction de décongélation et d'arrêt.
 Régulateur de brunissement réglable : choisissez parmi 7 niveaux pour griller selon vos souhaits.
 Rainure allongée pour des tranches extra larges ou pour plus d'une tranche de pain.
 Grille supplémentaire pour réchauffer des viennoiseries ou du pain (69360).
 Intègre un plateau pratique sur lequel se déposent les miettes.

Für einfaches und schnelles Toasten ohne Fett.
 Mit Auftau- und Abbruchtaste.
 Einstellbarer Regler mit 7 Bräunungsstufen ganz nach dem eigenen Geschmack.
 Extra lange Röstkammer für eine große oder mehrere kleine Brotscheiben.
 Zusätzliches Rost zum Erwärmen von Brötchen oder Brot (69360).
 Mit praktischer Krumenwanne.

Fast and easy toasting without the need to use any fatty products.
 Defrost and cancel functions.
 Adjustable darkness regulator. Choose from 7 levels for toasting as you like.
 Long slot for extra wide slices of bread or more than one slice of bread at once.
 Additional grill to heat buns or bread (69360).
 It has a practical tray for catching crumbs.

Permite tostar de forma rápida e fácil, sem necessidade de acrescentar nenhum tipo de gordura.
 Função de descongelação e botão de cancelamento.
 Regulador de tostagem com 7 níveis diferentes, para o ajustar ao gosto pessoal.
 Ranura longa para fatias extra longas, ou para mais do que uma fatia de pão.
 Grelha adicional para aquecer bolos ou pão (69360).
 Incorpora uma prática bandeja para recolher as migalhas.



Termostato: 7 posiciones de tostado
 Thermostat: 7 positions grilles
 Thermostat: 7 Positionen gerüstet
 Thermostat: 7 positions toasted
 Termostato: 7 posições crudadas



Dispone de función descongelar
 Dispose d'une fonction de décongélation
 Mit Auftaufunction
 It has a defrost function
 Com função de descongelação



Bandeja recogemigas
 Plateau ramasse miettes
 Krumenbehälter
 Crumb tray
 Bandeja recoge migalhas



Patas de apoyo antideslizantes
 Pieds d'appui antidérapants
 Rutschfeste Standfüße
 Non slip supports
 Patas de apoio antidesslizantes

Ranura alargada de 25 x 4 cm
 25 x 4 cm slot for extra wide slices



Inox

Tostadora doble ranura larga
 Grille pain double rainure longue
 Toaster mit doppelt langer Öffnung
 Double long groove toaster
 Dorradeira ranhura larga duplo

Ref	€	W	U.Venta
69260	52,19	1500	1



Ranura alargada de 24,5 x 4 cm
 24,5 x 4 cm slot for extra wide slices



Inox
18/10

Tostadora ranura larga
 Grille pain rainure longue
 Toaster, lange Öffnung
 Long groove toaster
 Torradeira ranhuras largas

Ref	€	L	U.Venta
69360	53,85	1000	1

Ref	Tensión/Voltage	Potencia/Power	Selector/Selector	Dimensiones/Sizes	Peso/Weight
69260	220-240 V, 50/60 Hz	1500 W	Dos ranuras - Two groves	43x20x23 cm	3,10 Kg
69360	220-240 V, 50/60 Hz	1000 W	Una ranura - One groove	41X12X18,5 cm	1,40 Kg





GASTRO

Cubetas
Containers

Transporte · Estanterías
Transport · Shelves

Cestas
Racks

Limpieza
Cleaning

▶ SOPORTE PARA CUBETAS GASTRONORM

New



Inox
18/10

Fabricado en acero inoxidable 18/10.
Organiza los alimentos y ahorra tiempo en la preparación de platos.
Ideal para cocinas profesionales, restaurantes, buffet, autoservicios, etc.
Travesaños verticales amovibles diseñados para combinar cubetas de distintos tamaños de hasta 200 mm de profundidad.
Pies de goma antideslizantes que garantizan una óptima estabilidad.

Fabriqué en acier inoxydable 18/10.
Organisez les aliments et gagnez du temps lors de la préparation de vos plats.
Idéal pour les cuisines professionnelles, les restaurants, les buffets, les self-services, etc.
Barres transversales verticales amovibles conçues pour combiner des bacs de différentes tailles de 200 mm de profondeur.
Pieds en caoutchouc antidérapants qui garantissent une stabilité optimale.

Aus hochwertigem Edelstahl 18/10.
Zum schnellen Anrichten zubereiteter Speisen.
Ideal für gewerbliche Küchen, Gaststätten, Buffets, Selbstbedienungsrestaurant usw.
Behälter unterschiedlicher Größe durch versetzbare Querstreben kombinierbar
zu 200 mm Tiefe kombinierbar.
Antirutschfüße aus Gummi für optimale Standfestigkeit.

Made of 18/10 stainless steel.
Organize food and save time while making dishes.
Perfect for professional chefs, restaurants, buffets, self-service, etc.
It has removable vertical cross pieces designed to combine trays of different sizes to 200 mm deep.
The non-slip rubber feet ensure optimum stability.

Fabricado em aço inoxidável 18/10.
Organize os alimentos e poupe tempo na preparação dos seus pratos.
Ideal para cozinhas profissionais, restaurantes, buffet, autoserviços, etc.
Travessas verticais amovíveis, desenhadas para combinar coveitas de diferentes tamanhos de até 200 mm de profundidade.
Pés de borracha antideslizantes, que asseguram uma ótima estabilidade.

Cubetas GN no incluídas

Bacs GN non inclus - GN-behälter nicht inbegriffen - GN trays not included
Covétes GN não incluídas

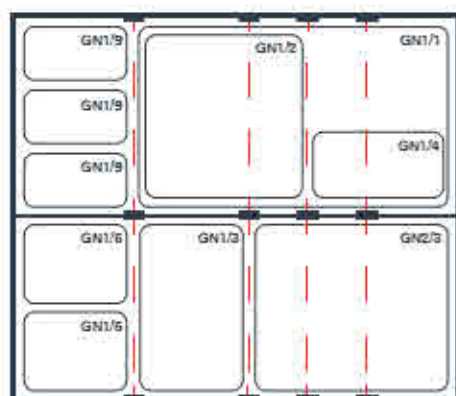

Diversas combinaciones posibles

Several possible combinations:



Soporte para cubetas Gastronorm

Support de bacs Gastronorm
Unterstützung für Gastronorm-Küvetten
Gastronorm cuvette support
Suporte de cubeta Gastronorm

Ref	€	cm	Cubeta (cm)	U.Venta	
A 66245	70.45	78x49x46	34x26,5x2	1	Soporte simple - Simple support
B 66246	90.68	78x78x63	34x26,5x2	1	Soporte doble - Double

▶ CUBETAS INOX 18/10 · INOX

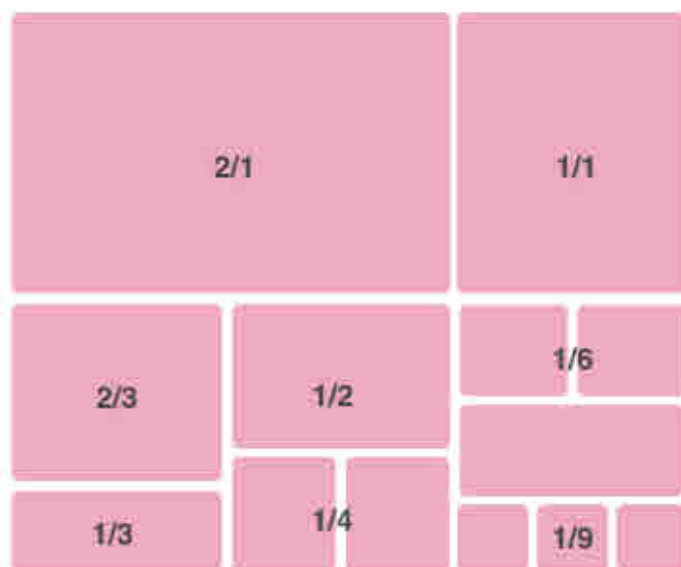

Fabricadas en Acero Inoxidable y Acero inoxidable 18/10.
Apilables.
Aptas para procesos de refrigeración, congelación, hornos microondas o distribución de alimentos.
Higiénicos y fácilmente lavables, aptas para el lavavajillas.

Fabricadas en acier inoxydable et en acier inoxydable 18/10.
Empilables.
Compatibles pour des processus de réfrigération, congélation, fours à micro-ondes ou distribution d'aliments.
Hygiéniques et facilement lavables, compatible lave-vaisselle.

Hergestellt aus Edelstahl und Edelstahl 18/10.
Stapelbar.
Geeignet für Kühl-, Gefriervorgänge, Mikrowellenherde oder Nahrungsmittelverteilung.
Hygienisch und einfach zu reinigen, geschirrspülerfest.

Manufactured in stainless steel and stainless steel 18/10.
Stackable.
Suitable for refrigeration and freezing processes, microwave ovens or food distribution.
Hygienic and easily washable, dishwasher safe.

Fabricadas em aço inoxidável e aço inoxidável 18/10.
Empilháveis.
Aptas para processos de refrigeração, congelação, fornos micro-ondas ou distribuição de alimentos.
Higiénicos e facilmente laváveis, aptas para a máquina de lavar louça.



Ø del agujero perforado: Ø4 mm
Drilled hole Ø: Ø4 mm

Cubeta 2/1
Bac 2/1
GN-Behälter 2/1
Container 2/1
Caixa 2/1



Inox 18/10	€	Inox	€	h (mm)	L	U.Venta	
66002	41,60	66002Z	36,94	20	6,50	1	Bandeja
66040	45,96	66040Z	41,71	40	11,00	1	Bandeja
66065	52,29	66065Z	43,78	65	18,90	1	Bandeja
66010	63,91	66010Z	53,64	100	31,50	1	
66015	77,19	66015Z	67,33	150	44,90	1	
66020	100,33	66020Z	89,95	200	60,00	1	

2/1
330 x 650 mm

Cubeta Perforada 2/1
Bac perfore 2/1
GN-Behälter, perforiert, 2/1
Perforated container 2/1
Caixa perforada 2/1



Inox 18/10	€	Inox	€	h (mm)	U.Venta	
-	-	-	-	-	-	-
66042	56,34	-	-	40	1	NO perf. lateral
66067	70,97	66067Z	49,70	65	1	NO perf. lateral
66012	87,25	66012Z	61,21	100	1	NO perf. lateral
66017	130,52	-	-	150	1	NO perf. lateral

Cubeta 1/1
Bac 1/1
GN-Behälter 1/1
Container 1/1
Caixa 1/1



Inox 18/10	€	Inox	€	h (mm)	L	U.Venta	
66102	20,54	66102Z	17,43	20	3,00	1	Bandeja
66140	21,48	66140Z	18,57	40	5,50	1	Bandeja
66155	24,17	66155Z	19,71	55	7,20	1	Bandeja
66165	26,04	66165Z	20,34	65	8,50	1	Bandeja
66110	37,04	66110Z	27,60	100	13,30	1	
66115	43,89	66115Z	38,08	150	20,60	1	
66120	51,77	66120Z	46,07	200	30,00	1	

1/1
330 x 325 mm

Cubeta Perforada 1/1
Bac perfore 1/1
GN-Behälter, perforiert, 1/1
Perforated container 1/1
Caixa perforada 1/1



Inox 18/10	€	Inox	€	h (mm)	U.Venta	
66104	30,92	-	-	20	1	NO perf. lateral
66142	36,83	66142Z	20,75	40	1	
-	-	-	-	-	-	-
66167	40,67	66167Z	22,41	65	1	
66112	52,29	66112Z	31,33	100	1	
66117	77,61	66117Z	50,53	150	1	
66122	89,12	66122Z	61,32	200	1	

2/3
264 x 326 mm

Cubeta 2/3

Bac 2/3
GN-Behälter 2/3
Container 2/3
Caixa 2/3



Inox 18/10	€	Inox	€	h (mm)	L	U.Venta	
66502	17,74	66502Z	14,63	20	1,70	1	Bandeja
66540	22,51	66540Z	18,99	40	3,50	1	Bandeja
66565	25,73	66565Z	21,48	65	5,50	1	Bandeja
66510	31,96	66510Z	26,77	100	8,90	1	
66515	44,61	66515Z	37,35	150	13,60	1	
66520	59,45	66520Z	49,80	200	19,30	1	

Cubeta Perforada 2/3

Bac perfere 2/3
GN-Behälter, perforiert, 2/3
Perforated container 2/3
Caixa perfurada 2/3



Inox 18/10	€	Inox	€	h (mm)	U.Venta
-	-	-	-	-	-
-	-	-	-	-	-
-	-	66567Z	19,30	65	1
-	-	66512Z	27,39	100	1
-	-	66517Z	37,35	150	1

2/4
270 x 391 mm

Cubeta 2/4

Bac 2/4
GN-Behälter 2/4
Container 2/4
Caixa 2/4



Inox 18/10	€	Inox	€	h (mm)	L	U.Venta
67604	19,40	67604Z	16,19	40	1,80	1
67665	22,00	67665Z	18,05	65	4,50	1
67610	27,29	67610Z	22,51	100	5,50	1
67615	41,29	67615Z	33,82	150	8,50	1

1/2
263 x 325 mm

Cubeta 1/2

Bac 1/2
GN-Behälter 1/2
Container 1/2
Caixa 1/2



Inox 18/10	€	Inox	€	h (mm)	L	U.Venta	
66202	13,90	66202Z	9,75	20	1,20	1	Bandeja
66240	14,53	66240Z	10,06	40	2,50	1	Bandeja
-	-	66255Z	11,41	55	3,20	1	Bandeja
66265	15,60	66265Z	11,72	65	4,20	1	Bandeja
66210	24,17	66210Z	16,60	100	8,00	1	
66215	30,92	66215Z	23,86	150	9,90	1	
66220	39,53	66220Z	29,57	200	11,60	1	

Cubeta Perforada 1/2

Bac perfere 1/2
GN-Behälter, perforiert, 1/2
Perforated container 1/2
Caixa perfurada 1/2



Inox 18/10	€	Inox	€	h (mm)	U.Venta	
-	-	-	-	-	-	-
66242	26,15	-	-	40	1	NO perf. lateral
-	-	-	-	-	-	-
66267	29,88	-	-	65	1	
66212	36,73	-	-	100	1	
66217	49,70	-	-	150	1	
66222	68,99	-	-	200	1	

1/3
176 x 233 mm

Cubeta 1/3

Bac 1/3
GN-Behälter 1/3
Container 1/3
Caixa 1/3



Inox 18/10	€	Inox	€	h (mm)	L	U.Venta	
66302	12,97	66302Z	7,37	20	0,80	6	Bandeja
66340	13,07	66340Z	8,09	40	1,60	6	Bandeja
66355	13,49	66355Z	8,30	55	2,00	6	Bandeja
66365	13,70	66365Z	8,51	65	2,50	6	Bandeja
66310	19,61	66310Z	13,49	100	3,80	1	
66315	28,64	66315Z	18,05	150	5,90	1	
66320	32,89	66320Z	21,37	200	8,10	1	

1/4
265 x 172 mm

Cubeta 1/4

Bac 1/4
GN-Behälter 1/4
Container 1/4
Caixa 1/4



Inox 18/10	€	Inox	€	h (mm)	L	U.Venta
66402	9,75	66402Z	6,64	20	0,60	6
66465	10,89	66465Z	7,37	65	1,90	6
66410	16,29	66410Z	11,52	100	2,50	1
66415	22,31	66415Z	15,25	150	4,10	1
66420	30,40	66420Z	18,47	200	4,90	1

1/6
178 x 162 mm



Cubeta 1/6
Bac 1/6
GN-Behälter 1/6
Container 1/6
Caixa 1/6

Inox 18/10	€	Inox	€	h (mm)	L	U.Venta
66665	8,92	66665Z	5,91	65	1,10	6
66610	14,11	66610Z	9,03	100	1,60	6
66615	22,10	66615Z	12,66	150	2,50	1
66620	27,81	66620Z	14,94	200	3,30	1

1/9
178 x 108 mm



Cubeta 1/9
Bac 1/9
GN-Behälter 1/9
Container 1/9
Caixa 1/9

Inox 18/10	€	Inox	€	h (mm)	L	U.Venta
66965	7,58	66965Z	4,35	65	0,70	6
66910	13,28	66910Z	6,95	100	1,00	6

Guia divisora
Guide de division
GN Zwischensteg
Splitting guides
Guia divisória



Inox 18/10	€	Inox	€	L (mm)	U.Venta
66923	12,66	66923Z	5,29	530	1
66925	9,34	66925Z	3,42	325	1

Doble fondo perforado
Double fond perforé
Doppel-Boden gelocht
Punched double bottom perf.
Duplo fundo perforado



Inox 18/10	€	Inox	€	Cubeta	U.Venta
66909	96,07	-	-	2/1	
66911	30,61	66911Z	20,34	1/1	
66912	20,96	66912Z	13,80	1/2	

Tapa para cubeta
Couvercle pour bac
GN Deckel
Container lid
Tampa para caixa



Inox 18/10	€	Inox	€	Cubeta	U.Venta
66901D	23,03	66901DZ	15,98	1/1	1
66905D	18,26	66905DZ	11,00	2/3	1
66907	15,04	-	-	2/4	1
66902D	12,24	66902DZ	7,89	1/2	6
66903D	9,73	66903DZ	6,02	1/3	6
66904D	8,20	66904DZ	5,60	1/4	6
66906D	6,23	66906DZ	3,22	1/6	6
66909D	5,71	66909DZ	2,49	1/9	6

Tapa para cubeta
Couvercle pour bac
GN Deckel
Container lid
Tampa para caixa



Inox 18/10	€	Inox	€	Cubeta	U.Venta
67901	22,93	67901Z	16,08	1/1	1
67905	14,01	67905Z	9,75	2/3	1
67902	12,55	67902Z	8,72	1/2	6
67903	9,03	67903Z	6,33	1/3	6
67904	7,68	67904Z	5,29	1/4	6
67906	6,33	67906Z	4,36	1/6	6
67909	5,29	67909Z	3,74	1/9	6

SI

Silicone

Tapa para cubeta
Couvercle pour bac
GN Deckel
Container lid
Tampa para caixa



Inox 18/10	€	Inox	€	Cubeta	U.Venta
66901	58,06	66901Z	40,67	1/1	1
66903	54,88	66903Z	28,74	2/3	1
66902	49,80	66902Z	31,95	1/2	1
66904	40,26	66904Z	22,31	1/3	1
66905	37,35	66905Z	20,75	1/4	1

Inox

Parrilla
Grille
GN Drahtgitter
Grill
Grelha



Ref	€	cm	Cubeta	U.Venta
66920	46,07	65x53	2/1	1
66921	17,64	53x32,5	1/1	1

SI 200°C

Silicone max

Pinza para horno y bandeja GN
Pince Inox pour bac Gastronom
Zange für GN Behälter
Tong GN tray
Pinça para forno e bandejas GN



Ref	€	L (cm)	U.Venta
62989	14,63	20	12

Pinza con silicona para horno y bandeja GN
Pince Inox pour bac Gastronom avec Silicone
Zange für GN Behälter, mit Silikon
Oven tray tong with Silicone
Pinça para forno e bandejas com silicone



Ref	€	L (cm)	U.Venta
62998	14,63	20	12

CUBETAS POLICARBONATO

Cubeta GN 1/1

Bac GN 1/1
GN-Behälter 1/1
GN container 1/1
Caixa GN 1/1



1/1
336 x 325 mm



Fabricadas en policarbonato, ligeras, indeformables y apilables.
Aptas para procesos de refrigeración, congelación, hornos microondas o distribución de alimentos (-100°C / 100°C).
Higiénicos y fácilmente lavables, aptas para el lavavajillas.

Ref	€	h (mm)	L	U.Venta
66165P	20,13	65	8,50	1
66110P	24,80	100	13,30	1
66115P	30,40	150	20,60	1
66120P	37,45	200	30,00	1

Fabricées en polycarbonate, légères, indéformables et empilables.
Compatibles pour des processus de réfrigération, congélation, fours à micro-ondes ou distribution d'aliments (-100°C / 100°C).
Hygiéniques et facilement lavables, compatibles lave-vaisselle.

Aus Polycarbonat hergestellt, leicht, nicht verformbar und stapelbar.
Geegnet für Kühl-, Gefriervorgänge, Mikrowellentende oder Nahrungsmittelverteilung (-100°C / 100°C).
Hygienisch und einfach zu reinigen, geschwemmerfest.

Manufactured in polycarbonate, light, non-deformable and stackable.
Suitable for refrigeration and freezing processes, microwave ovens or food distribution (-100°C / 100°C).
Hygienic and easily washable, dishwasher safe.

Fabricadas em policarbonato, leves, indeformáveis e empilháveis.
Aptas para processos de refrigeração, congelação, fornos micro-ondas ou distribuição de alimentos (-100°C / 100°C).
Higiénicos e facilmente laváveis, apto para a máquina de lavar louça.

Cubeta GN 1/2

Bac GN 1/2
GN-Behälter 1/2
GN container 1/2
Caixa GN 1/2



1/2
336 x 325 mm

Ref	€	h (mm)	L	U.Venta
66265P	10,69	65	4,20	1
66210P	14,11	100	8,00	1
66215P	18,26	150	9,90	1
66220P	22,31	200	11,60	1

Fabricadas em policarbonato, leves, indeformáveis e empilháveis.
Aptas para processos de refrigeração, congelação, fornos micro-ondas ou distribuição de alimentos (-100°C / 100°C).
Higiénicos e facilmente laváveis, apto para a máquina de lavar louça.

Cubeta GN 1/3

Bac GN 1/3
GN-Behälter 1/3
GN container 1/3
Caixa GN 1/3



1/3
176 x 325 mm

Ref	€	h (mm)	L	U.Venta
66365P	8,72	65	2,50	1
66310P	11,31	100	3,80	1
66315P	14,01	150	5,90	1
66320P	17,12	200	8,10	1

Cubeta GN 1/4

Bac GN 1/4
GN-Behälter 1/4
GN container 1/4
Caixa GN 1/4



1/4
265 x 182 mm

Ref	€	h (mm)	L	U.Venta
66465P	7,78	65	1,90	1
66410P	9,13	100	2,50	1
66415P	11,62	150	4,10	1

Cubeta GN 1/6

Bac GN 1/6
GN-Behälter 1/6
GN container 1/6
Caixa GN 1/6



1/6
176 x 182 mm

Ref	€	h (mm)	L	U.Venta
66665P	6,54	65	1,10	1
66610P	6,95	100	1,60	1
66615P	8,30	150	2,50	1

Cubeta GN 1/9

Bac GN 1/9
GN-Behälter 1/9
GN container 1/9
Caixa GN 1/9



1/9
176 x 108 mm

Ref	€	h (mm)	L	U.Venta
66910P	6,54	100	0,70	1

Tapa

Couvercle
Deckel
Lid
Tampa



Ref	€	Cubeta	U.Venta
66901P	15,46	1/1	1
66902P	9,55	1/2	1
66903P	6,74	1/3	1
66904P	5,60	1/4	1
66906P	4,15	1/6	1
66909P	3,32	1/9	1

Doble fondo perforado

Double fond perforé
Doppel-Boden gelocht
Punched double bottom perf.
Duplo fundo perforado



Ref	€	Cubeta	U.Venta
66911P	11,62	1/1	1
66912P	6,43	1/2	1
66913P	4,05	1/3	1
66914P	3,22	1/4	1
66916P	2,91	1/6	1

CUBETAS POLIPROPILENO

Cubeta 1/1

Bac 1/1
GN-Behälter 1/1
Container 1/1
Caixa 1/1



1/1
839 x 325 mm



Ref	€	h (mm)	L	U.Venta
66165H	9,44	65	8,50	1
66110H	11,31	100	12,90	1
66115H	14,11	150	19,50	1
66120H	18,05	200	25,90	1



Fabricadas en polipropileno, ligeros, indeformables y apilables.
Cierre hermético. Higiénicas y fácilmente lavables.
Aptas para procesos de refrigeración, congelación o distribución de alimentos (-40°C / 70°C).

Cubeta 1/2

Bac 1/2
GN-Behälter 1/2
Container 1/2
Caixa 1/2



1/2
266 x 325 mm

Ref	€	h (mm)	L	U.Venta
66265H	4,98	65	3,90	6
66210H	6,95	100	5,90	6
66215H	8,09	150	8,80	6
66220H	9,55	200	10,80	1

Fabricées en polypropylène, légères, indéformables et empilables.
Fermeture hermétique. Hygiéniques et facilement lavables.
Compatibles pour des processus de réfrigération, congélation ou distribution d'aliments (-40°C / 70°C).

Aus Polypropylen hergestellt, leicht, nicht verformbar und stapelbar.
Hermetischer Verschluss. Hygienisch und einfach zu reinigen.
Geignet zum Kühlen, Einfrieren oder zur Verteilung von Lebensmitteln (-40°C/ 70°C).

Manufactured in polypropylene, light, non-deformable and stackable.
Airtight seal. Hygienic and easily washable.
Suitable for refrigeration and freezing processes and food distribution (-40°C/ 70°C).

Fabricadas em polipropileno, leves, indeformáveis e empilháveis.
Fechamento hermético. Higiénicas e facilmente laváveis.
Aptas para processos de refrigeração, congelação ou distribuição de alimentos (-40° C / 70° C).

Cubeta 1/3

Bac 1/3
GN-Behälter 1/3
Container 1/3
Caixa 1/3



1/3
176 x 325 mm

Ref	€	h (mm)	L	U.Venta
66365H	3,94	65	2,40	6
66310H	4,77	100	3,80	6
66315H	5,81	150	5,10	6
66320H	7,06	200	6,90	6

Cubeta 1/4

Bac 1/4
GN-Behälter 1/4
Container 1/4
Caixa 1/4



1/4
266 x 162 mm

Ref	€	h (mm)	L	U.Venta
66465H	3,32	65	1,70	6
66410H	4,56	100	2,40	6
66415H	4,77	150	3,70	6

Cubeta 1/6

Bac 1/6
GN-Behälter 1/6
Container 1/6
Caixa 1/6



1/6
176 x 162 mm

Ref	€	h (mm)	L	U.Venta
66665H	3,01	65	1,00	6
66610H	3,22	100	1,60	6
66615H	4,46	150	2,20	6

Cubeta 1/9

Bac 1/9
GN-Behälter 1/9
Container 1/9
Caixa 1/9



1/9
176 x 108 mm

Ref	€	h (mm)	L	U.Venta
66965H	2,08	65	0,60	6
66910H	3,01	100	0,90	6

Tapa

Couvercle
Deckel
Lid
Tampa



Doble fondo perforado

Double fond perforé
GN Einlege-Böden, gelocht
Punched double bottom
Duplo fundo perforado



Ref	€	Cubeta	U.Venta
66901DH	7,16	1/1	6
66902DH	4,25	1/2	6
66903DH	3,11	1/3	6
66904DH	2,59	1/4	6
66906DH	1,87	1/6	6
66909DH	1,76	1/9	6

Ref	€	Cubeta	U.Venta
66911H	8,20	1/1	10
66912H	4,26	1/2	12
66913H	2,39	1/3	12
66914H	1,87	1/4	12
66916H	1,35	1/6	12

▶ CUBETAS MELAMINA WHITE & BLACK



Ligeras, indeformables y apilables.
Higiénicas y fácilmente lavables.
Aptas para procesos de refrigeración, congelación o distribución de alimentos.

Légeres, indéformables et empilables.
Hygiéniques et facilement lavables.
Compatibles pour des processus de réfrigération, congélation ou distribution d'aliments.

Leicht, nicht verformbar und stapelbar.
Hygienisch und einfach zu reinigen.
Geeignet zum Kühlen, Einfrieren oder zur Verteilung von Lebensmitteln.

Light, non-deformable and stackable
Hygienic and easily washable
Suitable for refrigeration and freezing processes and food distribution

Leves, indéformáveis e empilháveis.
Higiénicos e facilmente laváveis.
Aptos para processos de refrigeração, congelação ou distribuição de alimentos.

Cubeta 1/1
Bac 1/1
GN-Behälter 1/1
Container 1/1
Caixa 1/1



Ref	€	h (mm)	L	U.Venta
66165E	37,35	65	8,50	1
66110E	42,43	100	13,30	1

Cubeta 1/1
Bac 1/1
GN-Behälter 1/1
Container 1/1
Caixa 1/1



Ref	€	h (mm)	L	U.Venta
66165J	39,74	65	8,50	1
66110J	44,72	100	13,30	1

1/1
133 x 335 mm

Cubeta 1/2
Bac 1/2
GN-Behälter 1/2
Container 1/2
Caixa 1/2



Ref	€	h (mm)	L	U.Venta
66265E	19,51	65	4,50	1
66210E	21,68	100	8,00	1

Cubeta 1/2
Bac 1/2
GN-Behälter 1/2
Container 1/2
Caixa 1/2



Ref	€	h (mm)	L	U.Venta
66265J	20,34	65	4,50	1
66210J	23,03	100	8,00	1

1/2
285 x 225 mm

Cubeta 1/3
Bac 1/3
GN-Behälter 1/3
Container 1/3
Caixa 1/3



Ref	€	h (mm)	L	U.Venta
66365E	15,15	65	2,50	1
66310E	16,91	100	3,80	1

Cubeta 1/3
Bac 1/3
GN-Behälter 1/3
Container 1/3
Caixa 1/3



Ref	€	h (mm)	L	U.Venta
66365J	16,29	65	2,50	1
66310J	18,05	100	3,80	1

1/3
175 x 225 mm

1/4
263 x 162 mm

Cubeta 1/4

Bac 1/4
GN-Behälter 1/4
Container 1/4
Caixa 1/4



Ref	€	h (mm)	L	U.Venta
66465E	13,07	65	1,90	1
66410E	14,73	100	2,50	1

Cubeta 1/4

Bac 1/4
GN-Behälter 1/4
Container 1/4
Caixa 1/4



Ref	€	h (mm)	L	U.Venta
66465J	13,90	65	1,90	1
66410J	15,77	100	2,50	1

2/3
350 x 225 mm

Cubeta 2/3

Bac 2/3
GN-Behälter 2/3
Container 2/3
Caixa 2/3



Ref	€	h (mm)	L	U.Venta
66565E	28,12	65	5,50	1

Cubeta 2/3

Bac 2/3
GN-Behälter 2/3
Container 2/3
Caixa 2/3



Ref	€	h (mm)	L	U.Venta
66565J	29,36	65	5,50	1

1/6
170 x 102 mm

Cubeta 1/6

Bac 1/6
GN-Behälter 1/6
Container 1/6
Caixa 1/6



Ref	€	h (mm)	L	U.Venta
66665E	9,34	65	1,10	1
66610E	10,48	100	1,60	1

Cubeta 1/6

Bac 1/6
GN-Behälter 1/6
Container 1/6
Caixa 1/6



Ref	€	h (mm)	L	U.Venta
66665J	9,96	65	1,10	1
66610J	11,31	100	1,60	1

2/4
330 x 185 mm

Cubeta 2/4

Bac 2/4
GN-Behälter 2/4
Container 2/4
Caixa 2/4



Ref	€	h (mm)	L	U.Venta
66765E	19,61	65	4,50	1

Cubeta 2/4

Bac 2/4
GN-Behälter 2/4
Container 2/4
Caixa 2/4



Ref	€	h (mm)	L	U.Venta
66765J	20,23	65	4,50	1

Transporte - Estanterías
Transport - Shelves

#CocinaConLacor



▶ TERMOTRANS



Diseñado para el transporte de cubetas.
Contenedor isotérmico rígido, ligero, robusto y apilable.
Puerta sin bisagra, sistema de cierre en la tapa.
Ideal para transporte de alimentos en catering o cocinas.

Conçu pour le transport de bacs.
 Conteneur isotherme rigide, léger, robuste et empilable.
 Porte sans charnière, système de verrouillage sur le couvercle.
 Idéal pour le transport des aliments de restauration ou de cuisson.

Entwickelt für den Transport von GN-Behältern.
 Thermobehälter starr, leicht, robust und stapelbar.
 Tür ohne Scharnier, Verriegelungssystem des Deckels.
 Ideal für den Transport von Lebensmitteln in Catering oder Köchen.

Designed for transporting containers.
 Isothermal container rigid, lightweight, sturdy and stackable.
 Door without hinges, locking system on the lid.
 Ideal for transporting food catering or cooking.

Projetado para transportar caixas.
 Recipiente isotérmico rígido, leve, resistente e empilhável.
 Porta sem dobradiça, sistema de bloqueio sobre a tampa.
 Ideal para o transporte de alimentos em restauração ou cozinha.



Thermotrans 100 17 L

Thermotrans
 Thermotrans
 Thermotrans
 Thermotrans

Ref	€	cm	U.Venta
66099	537,01	41x62x24	1



Thermotrans 300 34 L

Thermotrans
 Thermotrans
 Thermotrans
 Thermotrans

Ref	€	cm	U.Venta
66299	574,98	41x62x37	1



Thermotrans 600 72L

Thermotrans
 Thermotrans
 Thermotrans
 Thermotrans

Ref	€	cm	U.Venta
66599	710,48	45x62,5x57,5	1



CARROS

Inox

Tubo AISI 304 Ø25 mm. Espesor chapa 1,6 mm
Tubo AISI 304 Ø 25 mm. Sheet thickness 1.6 mm



Carro servicio 2 bandejas desmontable

Amovible chariot de service 2 plateaux
Servierwagen, 2 Regale, Abnehmbar
Removable service trolley 2 shelves
Carro serviço 2 bandejas desmontável

Ref	€	cm	U.Venta
66249	161,33	82x64,5x94,5	1

Entrega desmontado - Dismantled delivery



Carro servicio 3 bandejas desmontable

Amovible chariot de service 3 plateaux
Servierwagen, 3 Regale, Abnehmbar
Removable service trolley 3 shelves
Carro serviço 3 bandejas desmontável

Ref	€	cm	U.Venta
66349	208,85	82x64,5x94,5	1

Entrega desmontado - Dismantled delivery



Carro servicio 3 bandejas soldado

Chariot de service 3 plateaux
Servierwagen, 3 Regale
Service trolley 3 shelves
Carro serviço 3 bandejas soldado

Ref	€	cm	U.Venta
66350	607,98	82x64,5x94,5	1

Entrega montado - Mounted delivery



Carro servicio 3 bandejas

Chariot de service avec 3 plateaux
Servierwagen, 3 Regale
Service trolley with 3 shelves
Carro serviço 3 bandejas

Ref	€	cm	U.Venta
66353	227,32	103x49x95	1

Entrega desmontado - Dismantled delivery

Contenedor cubiertos plástico

Bac plastique pour couverts
Besteckebehälter aus Plastik
Cutlery plastic bin
Recipiente de talheres plástico



Ref	€	cm	U.Venta
66351	33,51	33x23x18	1

Contenedor desperdicios plástico

Bac à déchets plastique
Müllbehälter aus Plastik
Rubbish plastic bin
Recipiente de desperdicios em plástico



Ref	€	cm	U.Venta
66352	66,03	33x28x66	1



Carro portaplatos

Chariot porte-plateau
Tellerwagen
Dish cart
Carro porta-pratos

Ref	€	cm	h (cm)	U.Venta
66555	1.152,77	96x71	81,0	1



Funda carro portaplatos

Housse chariot porte-plateau
Abdeckung für tellerwagen
Dish cart cover
Capa protectora carro porta-pratos

Ref	€	cm	U.Venta
62964	41,09	96x71x60	1



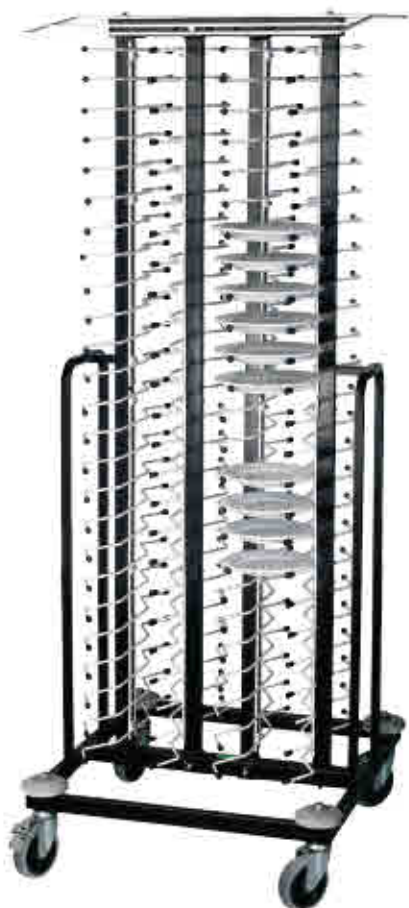

MAX: Ø28 cm
MIN: Ø8 cm
CAP : 100 unit

Carro portaplatos con ruedas 100 platos

Hors devoirs chariot 100 plate
Tellertransportwagen 100 teller
100 Plate stack trolley assembled
Carro porta-plateos com rodas 100 pratos

Ref	€	cm	U.Venta
66550	1.456,86	70x70x195	1

Entrega montado - Mounted delivery

Carro portabandejas

Chariot à glissières
Gestellwagen
Rack trolley
Carro porta-bandejas

Ref	€	Cubeta	Baldas	A (cm)	cm	U.Venta
66116	783,11	GN 1/1	17	7,5	38x55x172	1
66118	869,53	GN 2/1	17	7,5	58x69x172	1
66642	732,79	60x40	20	6,0	45x62x172	1

Entrega desmontado - Dismantled delivery

Ø tubo - tube: 1,7 cm

Separación entre tubos - Separation between tubes: 5 cm

Inox
18/10



Estante tubular Inox

Étagère tubulaire en Inox
Rohrstell Regal, Roettfel
St. steel tubular shelf
Prateleira tubular Inox

250 mm				
Ref	€	L (mm)	L (mm)	U.Venta
56212	108,52	1200	250	
56216	118,28	1600	250	

400 mm				
Ref	€	L (mm)	L (mm)	U.Venta
56412	157,60	1200	400	1
56416	168,70	1600	400	1



► POLICARBONATO



Rendimiento Térmico de las bandejas : Thermal isolation rate

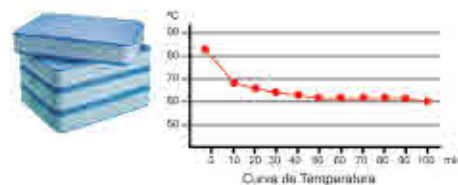

Bandeja Isotérmica B-1
 Plateau isotherme B-1
 Isothermal Schale/Tablett B-1
 Isothermal B-1, Tray
 Bandeja Isotérmica B-1

Ref	€	cm	U.Venta
66930	179,18	55x38	1

COMPOSICIÓN:
 66930 - Bandeja isotérmica B-1
 66933 - Plato llano con tapa
 66934 - Plato hondo con tapa
 66937 - Bol con tapa
 66939 - Bol rectangular con tapa
 66956 - Cierre portafichas hermético



6 Pcs.

Set completo bandeja Isotérmica B-1
 Set complet B-1
 Komplet-Set B-1
 Complete set B-1
 Conjunto completo bandeja Isotérmica B-1

Ref	€	cm	U.Venta
66942	208,12	55x38	1

Cierre portafichas hermético
 Porte fiche
 Halterung für Inhaltverzeichnis
 Index card fastener
 Fecho para bandejas isotérmicas



Ref	€	U.Venta
66955	2,28	1

Tapa
PC
Polycarbonate

Plato llano Policarbonato con tapa
 Assiette plate polycarbonate avec couvercle
 Grosser Teller, Polycarbonat mit deckel
 Polycarbonate dinner plate with lid
 Plato raso policarbonato com tampa



Ref	€	cm	U.Venta
66933	13,38	Ø22x3	1
66933C	9,44	-	1
66940	3,94	-	12

Tapa
PP
Polypropylene

Plato hondo Policarbonato con tapa
 Assiette creuse polycarbonate avec couvercle
 Suppenteller, Polycarbonat mit deckel
 Polycarbonate soup plate with lid
 Plato fundo policarbonato com tampa



Ref	€	cm	ml	U.Venta
66934	8,82	Ø19x5	450	1
66934C	4,98	-	450	1
66939	3,84	-	-	1

Tapa
PP
Polypropylene

Bol Policarbonato con tapa
 Bol polycarbonate avec couvercle
 Schüssel, Polycarbonat mit deckel
 Polycarbonate bowl with lid
 Tijela policarbonato com tampa



Ref	€	cm	ml	U.Venta
66937	5,71	Ø13x6,5	450	1
66937C	4,46	-	450	1
66938	1,25	-	-	1

Tapa
PP
Polypropylene

Bol doble pared Policarbonato con tapa
 Bol isotherme Polycarb. a/couvercle
 Polycarbonat Schüssel, Isothermal mit Deckel
 Double wall Polycarbonate bowl w/lid
 Tijela parede dupla policarbonato com tampa



Ref	€	Ø (cm)	ml	U.Venta
66948	12,04	12,5x7	500	1
66948S	10,79	12,5x7	500	1
66938	1,25	12,5	-	1

Tapa
PP
Polypropylene

Taza doble pared Policarbonato con tapa
 Coupelle dessert isotherme Polycarb. a/couvercle
 Doppelwandiger Becher Polycarbonat mit Deckel
 Double wall Polycarbonate mug w/lid
 Chávena parede duplo policarbonato com tampa



Ref	€	Ø (cm)	ml	U.Venta
66949	10,89	8,5x7	250	1
66949S	9,75	8,5x7	250	1
66949T	1,14	8,5	-	1

Tapa
PP
Polypropylene

Taza desayuno Policarbonato con tapa
 Coupelle dessert polycarbonate a/couvercle
 Frühstückstasse Polycarbonat mit Deckel
 Polycarbonate breakfast cup w/lid
 Chávena pequeno-almoço policarbonato com tampa



Ref	€	Ø (cm)	ml	U.Venta
66936	4,57	9x7	300	1
66936C	3,53	9x7	300	1
66936T	1,04	9	-	1

Plato desayuno Policarbonato

Assiette dessert polycarbonate
Frühstücksteller, Polycarbonat
Polycarbonate breakfast plate
Prato de pequeno-almoço policarbonato



Ref	€	cm	U.Venta
66935	4,25	Ø18x2,5	1

Vaso Policarbonato

Verre polycarbonate
Glas, Polycarbonat
Polycarbonate glass
Copo policarbonato



	Ref	€	Ø (cm)	ml	U.Venta
A	66947	1,97	7x10	250	1
B	66932	2,70	8,3x9,5	300	12

Tapa

PP

Polypropylene

Bol cuadrado Policarbonato con tapa

Bac carre en Polycarbonate avec couvercle
Polycarbonat Behälter, Viereckig mit Deckel
Square Polycarbonate bowl with lid
Caixa quadrada policarbonato com tampa



Ref	€	cm	ml	U.Venta
66972	6,95	12x12x4,5	400	1
66972C	4,46	12x12x4,5	400	12
66975	2,49	12x12	-	1

Tapa

PP

Polypropylene

Bol rectangular Policarbonato con tapa

Bac rectangulaire en Polycarbonate avec couvercle
Polycarbonat Behälter, Rechteckig mit Deckel
Rectangular Polycarbonate bowl with lid
Caixa rectangular policarbonato com tampa



Ref	€	cm	ml	U.Venta
66974	9,03	17x12	600	1
66974C	5,71	17x12	600	1
66977	3,42	17x12	-	1

Bol rectangular Policarbonato con tapa

Bac rectangulaire en Polycarbonate avec couvercle
Polycarbonat Behälter, Rechteckig mit Deckel
Rectangular Polycarbonate bowl with lid
Caixa rectangular policarbonato com tampa



Ref	€	cm	ml	U.Venta
66959	6,95	9x13x4	400	1
66957S	4,15	-	-	1
66958	2,80	-	-	1

Tapa

PC

Polycarbonate

Jarra Policarbonato

Pot verser Polycarbonate
Krug, Polycarbonat
Polycarbonate jug
Jarra policarbonato



Ref	€	L	U.Venta
66945	10,27	1,00	1
66945S	7,89	1,00	1
66945T	2,39	-	1

Bandeja autoservicio

Plateau self-service
Selbstbedienung Tablett
Self-service tray
Bandeja auto-serviço



Ref	€	cm	U.Venta
A	16,91	33x33	1
B	10,38	33x33	1

125°C

max

Tapa cubreplatos redondo Policarbonato

Couvercle pour assiettes Polycarbonate
Polycarbonat Teller-Abdeckung
Polycarbonate round plate cover
Tampa cobre pratos redonda policarbonato



Ref	€	Ø (cm)	U.Venta
66950	10,38	25x7	1

PP

Polypropylene

Bandeja servicio

Plateau rectangulaire
Tablett, rechteckig
Rectangular tray
Bandeja de servir



Ref	€	cm	U.Venta
66953	15,04	53x37	1

Carro portabandejas 20 unidades

Chariot 20 plateaux
Wagen für Schale/Tablett (20)
Isothermal tray trolley 20 unit.
Carro porta-bandejas 20 unidades



Ref	€	cm	U.Venta
66931	2.735,89	90x62x148	1

ESTANTERÍAS



PP	AL	75°C -30°C	
Polypropileno	Aluminio		

Las estanterías modulares LACOR no precisan para su montaje/desmontaje de herramienta alguna, son fáciles de montar, robustas y ligeras. Construidas en materiales de alta calidad garantizan una larga duración, además de adecuarse al uso alimenticio en cámaras refrigeradas. La construcción modular permite al cliente adecuarse a la longitud y espacios disponibles, pudiendo ampliar y modificar la distribución en cualquier momento. Diseñadas para poder emplear cubetas GASTRONORM 2/1, 1/1 y 2/3, con dos anchuras de fondo disponibles, 560 mm y 385 mm. La distribución de los estantes permite el máximo aprovechamiento de la altura disponible, con un máximo de 11 estantes en altura 1750 mm y 12 estantes en altura de 2000 mm, con un peso máximo aproximado por estantería de 1.200 Kg. Con una altura útil mínima de 100 mm es especialmente recomendada para el almacenaje de medicamentos, artículos de ferretería o alimentos en conserva. Las distintas alturas de los estantes y su fácil montaje/desmontaje, permite que las distancias entre estantes puedan variarse a razón de 150 mm adicionales a los 100 mm iniciales (100mm/250mm/400mm/550mm).

Les étagères modulaires LACOR ne nécessitent aucun outil pour leur montage/démontage. Elles sont faciles à monter, robustes et légères. Elles sont construites dans des matériaux d'une grande qualité qui garantissent une longue durée de vie, et s'adaptent à une utilisation alimentaire dans les chambres froides. La construction modulaire permet au client de les adapter à la longueur et aux espaces disponibles, avec la possibilité d'agrandir ou de modifier la distribution à tout moment. Conçues pour l'emploi de bacs GASTRONORM 2/1, 1/1 et 2/3, avec deux largeurs de fond disponibles, 560 mm et 385 mm. L'agencement des étagères permet de profiter au maximum de la hauteur disponible, avec un nombre limite de 11 étagères en hauteur de 1750 mm et de 12 étagères en hauteur de 2000 mm, pour un poids maximum d'environ 1.200 Kg par étagère. Avec une hauteur utile minimale de 100 mm, elle est spécialement conseillée pour stocker des médicaments, des articles de quincaillerie ou des aliments en conserve. Les différentes hauteurs des étagères et leur facilité de montage/démontage permettant de varier la distance entre étagères de 150 mm supplémentaires par rapport aux 100 mm d'origine (100mm/250mm/400mm/550mm).

Für den Auf-/Abbau der Modulregale LACOR ist keinerlei Werkzeug erforderlich, sie sind einfach zu montieren, robust und leicht. Dank ihrer Fertigung aus hochwertigen Werkstoffen besitzen sie eine garantierte lange Lebensdauer und eignen sich für die Aufbewahrung von Lebensmitteln in Kühlräumen. Der modulare Aufbau ermöglicht es dem Kunden, sich an die zur Verfügung stehenden Längen- und Raumgröße anzupassen, wobei sich die Anordnung jederzeit erweitern und ändern lässt. Ausgelegt für den Einsatz von Behältern GASTRONORM 2/1, 1/1 und 2/3, verfügbar in zwei Tiefen (560 mm und 385 mm). Die Anordnung der Regalfächer ermöglicht die größtmögliche Nutzung der verfügbaren Höhe. Bis zu 11 Fächern bei einer Höhe von 1750 mm und 12 Fächern bei einer Höhe von 2000 mm. Höchstgewicht pro Regalfach ca. 1200 kg. Bei einer Mindestnutzhöhe von 100 mm eignet sich das Regal besonders für die Aufbewahrung von Medikamenten, Eisenwarenartikeln oder Lebensmittelkonserven. Die unterschiedlichen Höhen der Regalfächer und deren einfache Montage/Demontage bieten die Möglichkeit, die Abstände zwischen den Fächern nach dem anfänglichen Maß von 100 mm um jeweils 150 mm zu versetzen (100mm/250mm/400mm/550mm).

No tools are required in the assembly/disassembly of LACOR modular shelving; they are easy to assemble, robust and light. Built in top-quality material, they are guaranteed to be long-lasting, and also apt for storing food in refrigerators. Their modular construction allows the client to fit them lengthwise into the available space, being able to expand and modify their distribution at anytime. Designed for use with GASTRONORM 2/1, 1/1 and 2/3 trays, with two available depths, 560mm and 385mm. The shelves' distribution allows for maximum use of available height, with a maximum height of 11 shelves at 1750mm and 12 shelves at 2000mm, with an approximate maximum weight of 1,200kg per shelf. With a minimum height of 100mm, it's especially recommended for storing medicine, tools or canned foods. The different shelf heights and easy assembly / disassembly make it so the distances between shelves can vary by 150mm from the initial 100mm (100mm/250mm/400mm/550mm).

Prateleiras modulares LACOR não exigem para a montagem / desmontagem ferramentas alguma; são fáceis de instalar, robustas e leves. Construído em materiais de alta qualidade para assegurar a longo prazo, também adaptáveis para uso alimentar em refrigeração. A construção modular permite ao cliente adequar-se à largura e espaços disponíveis, pode-se estender e mudança a distribuição a qualquer momento. Projetado para poder usar cubetas GASTRONORM 2/1, 1/1 e 2/3, com duas larguras de fundo disponíveis, 560 mm e 385 mm. A distribuição das prateleiras permite o uso máximo da altura disponível, com no máximo 11 prateleiras na altura 1750 mm e 12 prateleiras na altura de 2000 mm, com um peso máximo aproximado por prateleira de 1.200 Kg. Com uma altura útil mínima de 100 mm, é especialmente recomendado para o armazenamento de medicamentos, ferragens e alimentos enlatados. As diferentes alturas das prateleiras e sua fácil montagem / desmontagem, permitem que as distâncias entre prateleiras sejam variadas em 150 mm adicionais aos 100 mm iniciais (100 mm / 250 mm / 400 mm / 550 mm).

Capacidad por estante
Capacity per shelf
Distribuir el peso uniformemente
Distributing the weight evenly

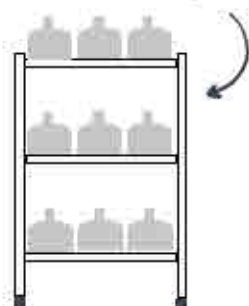

Long Max
< 1 m 120 Kg
> 1 m 100 Kg

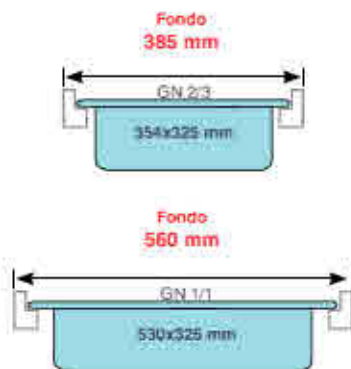

Instrucciones montaje

Las estanterías LACOR no precisan de herramienta alguna para su montaje o desmontaje, siga estas instrucciones para poder realizar el montaje de una estantería simple. En caso de precisar cualquier aclaración o información adicional no dude en ponerse en contacto con su suministrador o visite nuestra página web.

- 1.- Extraiga todos los componentes de su embalaje original, no se deshaga de éste hasta comprobar que el artículo se encuentra completo.
Coloque todos los componentes en el suelo.
- 2.- Disponga de un espacio libre, ampliamente superior a las dimensiones de la estantería a montar.
- 3.- Tome un soporte lateral extendido en el suelo, introduzca 2 ganchos en los orificios más bajos que vaya a emplear, tal y como muestra la Figura 1.
Apoye este soporte lateral contra la pared.
- 4.- Tome el otro soporte lateral, e introduzca los ganchos en los mismos orificios. Coloque ahora los 2 largueros de la parte inferior, Figura 2.
- 5.- Coloque de pie este soporte lateral y aproxímese al soporte lateral apoyado contra la pared, introduzca los largueros en los ganchos de éste, la estantería quedará estabilizada, Figura 3.
Asegúrese de que los largueros han sido correctamente colocados.
- 6.- Ahora puede seleccionar las diferentes alturas a las cuales colocará los ganchos y largueros de los estantes, Figura 4.
- 7.- Antes de colocar las parrillas plásticas, asegúrese de que todos los largueros se encuentran correctamente colocados.
- 8.- Montaje guía ángulo:
 - a.- Retire todas las parrillas plásticas y extraiga uno de los largueros de la estantería.
 - b.- Introduzca 2 ganchos de ángulo en la barra ángulo tal y como muestra la figura Figura 6 y 7.
NOTA: Deberá emplear tantas barras ángulo como estantes disponga. Figura 5.
 - c.- Introduzca el larguero por la barra ángulo con los ganchos laterales, según la Figura 8.
 - d.- Ahora coloque el larguero con las barras ángulo en su anterior ubicación. Realice el mismo proceso con todos los largueros de uno de los laterales.
 - e.- Una vez terminado, asegúrese de colocar todas las barras ángulo contra el mismo extremo, ahora realice el montaje de los 2 largueros de la parte inferior, Figura 9.
 - f.- Coloque en el nuevo soporte lateral 2 ganchos a la misma altura que la estantería ya montada.
 - g.- Monte el nuevo soporte lateral a los largueros que forman el ángulo, Figura 9, asegúrese de introducirlos correctamente.
 - h.- Ahora ya puede montar el resto de largueros hasta finalizar el montaje.
 - i.- Antes de colocar las parrillas plásticas, asegúrese de que todos los largueros se encuentran correctamente colocados
NOTA: Las patas pueden regularse en altura 1 cm para absorber irregularidades del suelo, emplee una llave inglesa o fija de 17 mm

Mounting instructions

The LACOR shelves do not need any tool whatsoever to be assembled or dismantled. Follow these instructions to be able to assemble one single shelf. If you need any further explanation or information, do not hesitate to contact your supplier or visit our website.

- 1.- Take all the components out of their original wrapping. Do not throw the wrapping away until you have checked that the article is complete.
Place all the components on the floor.
- 2.- Make a space available that is much larger than the shelf to be assembled.
- 3.- Take a side support lying on the floor and put two hooks into the lowest holes you are going to use, as shown in Figure 1. Lean this support against the wall.
- 4.- Take the other side support and put the hooks into the same holes. Now place the 2 lower rods, Figure 2.
- 5.- Stand this side support up and bring it next to the side support leaning against the wall. Put the rod lengths into its hooks. The shelf will remain stabilized, Figure 3.
Make sure the rod lengths have been properly placed.
- 6.- Now you can select the different heights at which you will place the hooks and the shelf rod lengths, Figure 4.
- 7.- Before placing the plastic racks, make sure that all the rods are properly in place.
- 8.- Assembly of angle guide rail:
 - a.- Remove all the plastic racks and take out one of the shelf rod lengths.
 - b.- Put 2 angle hooks into the angle bar as shown in Figure 6 and Figure 7.
NOTE: You must use as many angle bars as the number of shelves you have. Figure 5.
 - c.- Put the rod length through the angle bar with the side hooks, according to Figure 8.
 - d.- Now place the rod length with the angle bars in its previous place. Follow the same process with all the rod lengths of one of the sides.
 - e.- Once finished, make sure you place all the angle bars against the same end. Now assemble the 2 lower rod lengths, Figure 9.
 - f.- Place 2 hooks on the new side support at the same height as the shelf assembled.
 - g.- Mount the new side support onto the rod lengths that form the angle, Figure 9. Make sure you introduce them properly.
 - h.- Now you can assemble the rest of the rod lengths until you finish the assembly.
 - i.- Before placing the plastic racks, make sure that all the rod lengths are properly placed.
NOTE: The legs can be adjusted by 1 cm in height to absorb unevennesses in the floor. Use an adjustable or 17 mm fixed spanner.



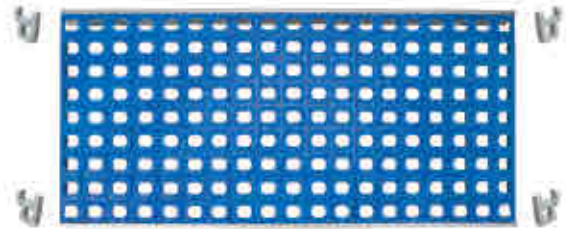

AL

Aluminium

Soporte lateral

Support latérale
Seitenständer
Lateral support
Suporte lateral

385 mm (GN 2/3)			560 mm (GN 1/1)		
Ref.	€	h (mm)	Ref.	€	
56302	27.60	250	57302	31.02	
56317	75.53	1750	57317	81.76	
56320	88.29	2000	57320	94.41	

10 estantes (máx) - 10 shelves (máx)

12 estantes (máx) - 12 shelves (máx)

PP

Polipropileno

AL

Aluminium

Estante completo

Étagère complète
Regal-Set
Shelf set
Prateleira completa

385 mm (GN 2/3)				560 mm (GN 1/1)			
Ref.	€	L (mm)	Fondo / Width	Ref.	€	U.Venta	Fondo / Width
56007	39.63	710		57007	46.69	1	
56008	42.12	820		57008	49.28	1	
56009	46.69	930		57009	53.54	1	
56010	53.54	1035		57010	63.50	1	
56011	57.89	1145		57011	67.75	1	
56012	61.42	1255		57012	72.11	1	
56013	63.50	1365		57013	76.26	1	
56014	72.11	1470		57014	84.14	1	
56015	74.18	1580		57015	89.02	1	

AL

Aluminium

Set ángulo 90°

Jeu angle 90°
Eckesatz 90°
90° corner set
Conjunto ángulo 90°



Ref.	€	L (mm)	U.Venta
56330	13.07	385	1
57330	16.70	560	1



Con freno
With brake

Rueda para estantería

Roue pour étagère
Rad für Regal
Shelf wheel
Roda para prateleira

Ref.	€	U.Venta
A 56522	38.60	1
B 56523	52.39	1

Repuestos

Pièces détachées · Ersatzteile · Spares · Sobresselentes

AL

Aluminium

Barra soporte lateral

Barre support latérale
Seitenständer stange
Lateral support bar
Barra soporte lateral

Ref	€	h (mm)	U.Venta
56502	7,78	250	1
56517	27,39	1750	1
56520	30,19	2000	1

AL

Aluminium

Travesaño soporte lateral

Longeron support latérale
Seitenständer traverse
Lateral support crossbar
Travesaño soporte lateral

Ref	€	L (mm)	U.Venta
56321	4,67	385	1
57321	6,85	560	1

Travesaño · Crossbar



PP

Polypropilena

Parrilla Polietileno

Clayete en polyéthylène
Polyethylen Boden/Raster
Polyethylene rack
Greiha polietileno

Ref	€	mm	U.Venta
56325	6,12	353x325	1
56435	7,06	353x425	3
57325	9,44	530x325	1
57435	11,62	530x435	1

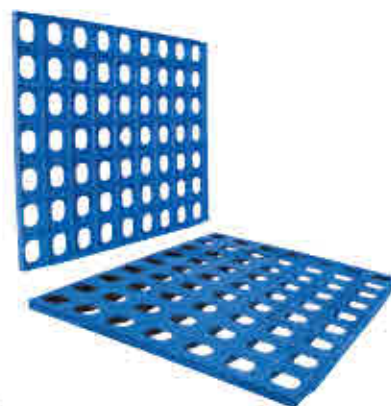

AL

Aluminium

Travesaño

Longeron
Traverse
Crossbar
Travesaño

Ref	€	L (mm)	U.Venta
56507	12,04	654	1
56508	12,76	766	1
56509	14,63	876	1
56510	15,98	981	1
56511	17,33	1091	1
56512	18,57	1201	1
56513	19,71	1311	1
56514	21,06	1416	1
56515	21,89	1526	1



AL

Aluminium

Set ángulo 90°

Jeu angle 90°
Eckesatz 90°
90° corner set
Conjunto ángulo 90°

Ref	€	L (mm)	U.Venta
56322	12,24	385	1
57322	15,77	560	1



AL

Aluminium

Jgo. 4 ganchos travesaño

Jeu 4 crochet pour longeron
4 Satz Haken für traverse
4 pcs. crossbar hooks
Jogo 4 ganchos travesaño

Ref	€	U.Venta
56524	2,59	1



AL

Aluminium

Jgo. 4 ganchos ángulo

Jeu 4 crochet pour angle
4 Satz Haken für ecke
4 pcs. set corner hooks
Jogo 4 ganchos ángulo

Ref	€	U.Venta
56527	2,08	1



**Inox
18/10**

Jgo. 6 tornillos

Jeu 6 vis en Inox
6 Satz schrauben
6 pcs. set screws
Jogo 6 parafusos

Ref	€	U.Venta
56526	1,87	1



PP

Polypropilena

Jgo. 2 pie nivelación

Jeu 2 pied nivellement
2 Satz niveau fusse
26 pcs. set level foot
2 jogo pé nivelamento

Ref	€	U.Venta
56525	4,05	1



Fondo - Width: 385 mm
 Altura - Height: 250 mm

PP	AL	75°C
Polypropilena	Aluminiu	-30°C

Bancada completa

Banc complet
 Bank, komplett
 Full bench
 Banco completo



1 Estante - Shelf

L (mm)	Ref	€	Desglose / Breakdown
710	55400	95.87	56302 x 2 / 56007 x 1
822	55401	97.94	56302 x 2 / 56008 x 1
932	55402	102.19	56302 x 2 / 56009 x 1
1037	55403	108.63	56302 x 2 / 56010 x 1
1147	55404	112.98	56302 x 2 / 56011 x 1
1257	55405	116.62	56302 x 2 / 56012 x 1
1367	55406	118.59	56302 x 2 / 56013 x 1
1472	55407	127.20	56302 x 2 / 56014 x 1
1582	55408	129.27	56302 x 2 / 56015 x 1

Fondo - Width: 560 mm
 Altura - Height: 250 mm

PP	AL	75°C
Polypropilena	Aluminiu	-30°C

Bancada completa

Banc complet
 Bank, komplett
 Full bench
 Banco completo



1 Estante - Shelf

L (mm)	Ref	€	Desglose / Breakdown
710	55700	108.94	57302 x 2 / 57007 x 1
822	55701	111.22	57302 x 2 / 57008 x 1
932	55702	115.47	57302 x 2 / 57009 x 1
1037	55703	125.43	57302 x 2 / 57010 x 1
1147	55704	129.69	57302 x 2 / 57011 x 1
1257	55705	134.05	57302 x 2 / 57012 x 1
1367	55706	138.09	57302 x 2 / 57013 x 1
1472	55707	146.70	57302 x 2 / 57014 x 1
1582	55708	150.75	57302 x 2 / 57015 x 1



Fondo - Width: 385 mm
 Altura - Height: 1.750 mm

PP	AL	75°C
Polypropylene	Aluminum	-30°C

Estanteria completa

Rayonnage complet
 Voile Regale
 Full shelving
 Estantes completa



SIMPLE

DOBLE - DOUBLE

TRIPLE

3 Estantes - Shelf

L (mm)	Ref	€	Desglose - Breakdown
710	55409	273.07	56317 x 2 - 56007 x 3
822	55410	279.71	56317 x 2 - 56009 x 3
932	55411	292.58	56317 x 2 - 56009 x 3
1037	55412	311.67	56317 x 2 - 56010 x 3
1147	55413	323.60	56317 x 2 - 56011 x 3
1257	55414	335.53	56317 x 2 - 56012 x 3
1367	55415	341.23	56317 x 2 - 56013 x 3
1472	55416	367.38	56317 x 2 - 56014 x 3
1582	55417	372.77	56317 x 2 - 56015 x 3

L (mm)	Ref	€	Desglose - Breakdown
1719	55418	509.31	56317 x 3 - 56007 x 3 - 56010 x 3
1829	55419	522.28	56317 x 3 - 56007 x 3 - 56011 x 3
1939	55420	533.17	56317 x 3 - 56007 x 3 - 56012 x 3
2046	55421	548.01	56317 x 2 - 56010 x 6
2154	55422	565.13	56317 x 3 - 56007 x 3 - 56014 x 3
2264	55423	571.46	56317 x 3 - 56007 x 3 - 56015 x 3
2376	55424	577.89	56317 x 3 - 56010 x 3 - 56013 x 3
2481	55425	603.62	56317 x 3 - 56010 x 3 - 56014 x 3
2591	55426	609.95	56317 x 3 - 56010 x 3 - 56015 x 3
2701	55427	622.81	56317 x 3 - 56011 x 3 - 56015 x 3
2811	55428	633.71	56317 x 3 - 56013 x 3 - 56014 x 3
2916	55429	658.81	56317 x 2 - 56014 x 6
3026	55430	664.73	56317 x 3 - 56014 x 3 - 56015 x 3
3136	55431	671.89	56317 x 3 - 56015 x 6

L (mm)	Ref	€	Desglose - Breakdown
3275	55432	807.59	56317 x 4 - 56010 x 6 - 56012 x 3
3385	55433	814.02	56317 x 4 - 56010 x 6 - 56013 x 3
3490	55434	839.65	56317 x 4 - 56010 x 6 - 56014 x 3
3598	55435	856.77	56317 x 4 - 56007 x 3 - 56014 x 6
3710	55436	865.69	56317 x 4 - 56011 x 6 - 56014 x 3
3818	55437	869.32	56317 x 4 - 56007 x 3 - 56015 x 6
3925	55438	895.36	56317 x 4 - 56010 x 3 - 56014 x 6
4035	55439	908.33	56317 x 4 - 56011 x 3 - 56014 x 6
4145	55440	911.55	56317 x 4 - 56010 x 3 - 56015 x 6
4255	55441	920.89	56317 x 4 - 56011 x 3 - 56015 x 6
4360	55442	951.08	56317 x 4 - 56014 x 9
4470	55443	957.41	56317 x 4 - 56014 x 6 - 56015 x 3
4580	55444	963.63	56317 x 4 - 56014 x 3 - 56015 x 6
4690	55445	970.06	56317 x 4 - 56015 x 9

4 Estantes - Shelf

Ref	€	Desglose - Breakdown
55446	313.01	56317 x 2 - 56007 x 4
55447	322.66	56317 x 2 - 56008 x 4
55448	338.74	56317 x 2 - 56009 x 4
55449	364.58	56317 x 2 - 56010 x 4
55450	381.90	56317 x 2 - 56011 x 4
55451	396.95	56317 x 2 - 56012 x 4
55452	405.35	56317 x 2 - 56013 x 4
55453	439.49	56317 x 2 - 56014 x 4
55454	447.99	56317 x 2 - 56015 x 4

Ref	€	Desglose - Breakdown
55455	603.51	56317 x 3 - 56007 x 4 - 56010 x 4
55456	620.32	56317 x 3 - 56007 x 4 - 56011 x 4
55457	634.43	56317 x 3 - 56007 x 4 - 56012 x 4
55458	654.77	56317 x 3 - 56010 x 8
55459	677.80	56317 x 3 - 56007 x 4 - 56014 x 4
55460	685.68	56317 x 3 - 56007 x 4 - 56015 x 4
55461	694.92	56317 x 3 - 56010 x 4 - 56013 x 4
55462	729.16	56317 x 3 - 56010 x 4 - 56014 x 4
55463	737.14	56317 x 3 - 56010 x 4 - 56015 x 4
55464	754.78	56317 x 3 - 56011 x 4 - 56015 x 4
55465	769.31	56317 x 3 - 56013 x 4 - 56014 x 4
55466	803.44	56317 x 3 - 56014 x 8
55467	811.74	56317 x 3 - 56014 x 4 - 56015 x 4
55468	820.46	56317 x 3 - 56015 x 8

Ref	€	Desglose - Breakdown
55469	976.29	56317 x 4 - 56010 x 8 - 56012 x 4
55470	984.69	56317 x 4 - 56010 x 8 - 56013 x 4
55471	1.018.83	56317 x 4 - 56010 x 8 - 56014 x 4
55472	1.041.55	56317 x 4 - 56007 x 4 - 56014 x 8
55473	1.053.27	56317 x 4 - 56011 x 8 - 56014 x 4
55474	1.058.46	56317 x 4 - 56007 x 4 - 56015 x 8
55475	1.093.21	56317 x 4 - 56010 x 4 - 56014 x 8
55476	1.115.73	56317 x 4 - 56011 x 4 - 56014 x 8
55477	1.121.43	56317 x 4 - 56010 x 4 - 56015 x 8
55478	1.127.24	56317 x 4 - 56011 x 4 - 56015 x 8
55479	1.167.29	56317 x 4 - 56014 x 12
55480	1.175.70	56317 x 4 - 56014 x 8 - 56015 x 4
55481	1.184.20	56317 x 4 - 56014 x 4 - 56015 x 8
55482	1.192.50	56317 x 4 - 56015 x 12

5 Estantes - Shelf

Ref	€	Desglose - Breakdown
55483	354.00	56317 x 2 - 56007 x 5
55484	364.58	56317 x 2 - 56008 x 5
55485	386.57	56317 x 2 - 56009 x 5
55486	418.74	56317 x 2 - 56010 x 5
55487	440.32	56317 x 2 - 56011 x 5
55488	458.47	56317 x 2 - 56012 x 5
55489	459.72	56317 x 2 - 56013 x 5
55490	501.53	56317 x 2 - 56014 x 5
55491	511.90	56317 x 2 - 56015 x 5

Ref	€	Desglose - Breakdown
55492	697.52	56317 x 3 - 56007 x 5 - 56010 x 5
55493	719.30	56317 x 3 - 56007 x 5 - 56011 x 5
55494	737.25	56317 x 3 - 56007 x 5 - 56012 x 5
55495	761.94	56317 x 3 - 56010 x 10
55496	790.37	56317 x 3 - 56007 x 5 - 56014 x 5
55497	800.95	56317 x 3 - 56007 x 5 - 56015 x 5
55498	812.05	56317 x 3 - 56010 x 5 - 56013 x 5
55499	854.80	56317 x 3 - 56010 x 5 - 56014 x 5
55500	865.38	56317 x 3 - 56010 x 5 - 56015 x 5
55501	886.86	56317 x 3 - 56011 x 5 - 56015 x 5
55502	904.91	56317 x 3 - 56013 x 5 - 56014 x 5
55503	947.45	56317 x 3 - 56014 x 10
55504	958.03	56317 x 3 - 56014 x 5 - 56015 x 5
55505	968.51	56317 x 3 - 56015 x 10

Ref	€	Desglose - Breakdown
55506	1.144.67	56317 x 4 - 56010 x 10 - 56012 x 5
55507	1.155.26	56317 x 4 - 56010 x 10 - 56013 x 5
55508	1.197.79	56317 x 4 - 56010 x 10 - 56014 x 5
55509	1.226.53	56317 x 4 - 56007 x 5 - 56014 x 10
55510	1.241.06	56317 x 4 - 56011 x 10 - 56014 x 5
55511	1.247.39	56317 x 4 - 56007 x 5 - 56015 x 10
55512	1.290.75	56317 x 4 - 56010 x 5 - 56014 x 10
55513	1.312.33	56317 x 4 - 56011 x 5 - 56014 x 10
55514	1.320.12	56317 x 4 - 56010 x 5 - 56015 x 10
55515	1.333.29	56317 x 4 - 56011 x 5 - 56015 x 10
55516	1.383.61	56317 x 4 - 56014 x 15
55517	1.394.19	56317 x 4 - 56014 x 10 - 56015 x 5
55518	1.404.78	56317 x 4 - 56014 x 5 - 56015 x 10
55519	1.415.25	56317 x 4 - 56015 x 15

It's easy to assemble
 - Access - 2 min



Fondo · Width: 385 mm
Altura · Height: 2.000 mm

PP | **AL** | **75°C**
Polipropileno | Aluminio | -30°C

Estantería completa
Rayonnage complet
Regale, komplett
Full shelving
Estantes completa

SIMPLE

DOBLE · DOUBLE

TRIPLE

3 Estantes - Shelf					4 Estantes - Shelf					5 Estantes - Shelf				
L (mm)	Ref	€	Desglose · Breakdown		Ref	€	Desglose · Breakdown		Ref	€	Desglose · Breakdown			
710	55520	298,49	56320 x 2	- 56007 x 3	55557	338,95	56320 x 2	- 56007 x 4	55594	379,62	56320 x 2	- 56007 x 5		
822	55521	304,92	56320 x 2	- 56008 x 3	55558	347,87	56320 x 2	- 56008 x 4	55595	390,72	56320 x 2	- 56008 x 5		
932	55522	316,54	56320 x 2	- 56009 x 3	55559	354,79	56320 x 2	- 56009 x 4	55596	411,89	56320 x 2	- 56009 x 5		
1037	55523	336,36	56320 x 2	- 56010 x 3	55560	390,41	56320 x 2	- 56010 x 4	55597	443,84	56320 x 2	- 56010 x 5		
1147	55524	349,85	56320 x 2	- 56011 x 3	55561	407,74	56320 x 2	- 56011 x 4	55598	465,53	56320 x 2	- 56011 x 5		
1257	55525	360,84	56320 x 2	- 56012 x 3	55562	422,06	56320 x 2	- 56012 x 4	55599	483,58	56320 x 2	- 56012 x 5		
1367	55526	367,07	56320 x 2	- 56013 x 3	55563	430,67	56320 x 2	- 56013 x 4	55600	494,16	56320 x 2	- 56013 x 5		
1472	55527	392,59	56320 x 2	- 56014 x 3	55564	464,70	56320 x 2	- 56014 x 4	55601	536,80	56320 x 2	- 56014 x 5		
1582	55528	398,92	56320 x 2	- 56015 x 3	55565	473,10	56320 x 2	- 56015 x 4	55602	547,28	56320 x 2	- 56015 x 5		
1719	55529	546,87	56320 x 3	- 56007 x 3 - 56010 x 3	55566	641,28	56320 x 3	- 56007 x 4 - 56010 x 4	55603	735,48	56320 x 3	- 56007 x 5 - 56010 x 5		
1829	55530	560,15	56320 x 3	- 56007 x 3 - 56011 x 3	55567	657,78	56320 x 3	- 56007 x 4 - 56011 x 4	55604	756,96	56320 x 3	- 56007 x 5 - 56011 x 5		
1939	55531	571,14	56320 x 3	- 56007 x 3 - 56012 x 3	55568	673,03	56320 x 3	- 56007 x 4 - 56012 x 4	55605	775,12	56320 x 3	- 56007 x 5 - 56012 x 5		
2046	55532	585,57	56320 x 2	- 56010 x 6	55569	692,74	56320 x 3	- 56010 x 8	55606	799,71	56320 x 3	- 56010 x 10		
2154	55533	602,89	56320 x 3	- 56007 x 3 - 56014 x 3	55570	715,56	56320 x 3	- 56007 x 4 - 56014 x 4	55607	828,34	56320 x 3	- 56007 x 5 - 56014 x 5		
2264	55534	609,12	56320 x 3	- 56007 x 3 - 56015 x 3	55571	723,24	56320 x 3	- 56007 x 4 - 56015 x 4	55608	838,82	56320 x 3	- 56007 x 5 - 56015 x 5		
2376	55535	615,86	56320 x 3	- 56010 x 3 - 56013 x 3	55572	732,48	56320 x 3	- 56010 x 4 - 56013 x 4	55609	849,92	56320 x 3	- 56010 x 5 - 56013 x 5		
2481	55536	641,38	56320 x 3	- 56010 x 3 - 56014 x 3	55573	767,02	56320 x 3	- 56010 x 4 - 56014 x 4	55610	892,56	56320 x 3	- 56010 x 5 - 56014 x 5		
2591	55537	647,61	56320 x 3	- 56010 x 3 - 56015 x 3	55574	775,32	56320 x 3	- 56010 x 4 - 56015 x 4	55611	903,04	56320 x 3	- 56010 x 5 - 56015 x 5		
2701	55538	660,78	56320 x 3	- 56011 x 3 - 56015 x 3	55575	792,75	56320 x 3	- 56011 x 4 - 56015 x 4	55612	924,62	56320 x 3	- 56011 x 5 - 56015 x 5		
2811	55539	670,54	56320 x 3	- 56013 x 3 - 56014 x 3	55576	807,07	56320 x 3	- 56013 x 4 - 56014 x 4	55613	942,78	56320 x 3	- 56013 x 5 - 56014 x 5		
2916	55540	696,27	56320 x 2	- 56014 x 6	55577	841,10	56320 x 3	- 56014 x 8	55614	985,42	56320 x 3	- 56014 x 10		
3026	55541	703,53	56320 x 3	- 56014 x 3 - 56015 x 3	55578	849,71	56320 x 3	- 56014 x 4 - 56015 x 4	55615	996,00	56320 x 3	- 56014 x 5 - 56015 x 5		
3136	55542	709,75	56320 x 3	- 56015 x 6	55579	858,01	56320 x 3	- 56015 x 8	55616	1.006,38	56320 x 3	- 56015 x 10		
3275	55543	858,12	56320 x 4	- 56010 x 6 - 56012 x 3	55580	1.026,71	56320 x 4	- 56010 x 8 - 56012 x 4	55617	1.195,20	56320 x 4	- 56010 x 10 - 56012 x 5		
3385	55544	864,55	56320 x 4	- 56010 x 6 - 56013 x 3	55581	1.035,22	56320 x 4	- 56010 x 8 - 56013 x 4	55618	1.205,78	56320 x 4	- 56010 x 10 - 56013 x 5		
3490	55545	890,18	56320 x 4	- 56010 x 6 - 56014 x 3	55582	1.069,25	56320 x 4	- 56010 x 8 - 56014 x 4	55619	1.248,42	56320 x 4	- 56010 x 10 - 56014 x 5		
3598	55546	907,29	56320 x 4	- 56007 x 3 - 56014 x 6	55583	1.091,97	56320 x 4	- 56007 x 4 - 56014 x 8	55620	1.276,96	56320 x 4	- 56007 x 5 - 56014 x 10		
3710	55547	916,01	56320 x 4	- 56011 x 6 - 56014 x 3	55584	1.103,80	56320 x 4	- 56011 x 8 - 56014 x 4	55621	1.291,58	56320 x 4	- 56011 x 10 - 56014 x 5		
3818	55548	919,85	56320 x 4	- 56007 x 3 - 56015 x 6	55585	1.108,88	56320 x 4	- 56007 x 4 - 56015 x 8	55622	1.297,91	56320 x 4	- 56007 x 5 - 56015 x 10		
3925	55549	945,89	56320 x 4	- 56010 x 3 - 56014 x 6	55586	1.143,64	56320 x 4	- 56010 x 4 - 56014 x 8	55623	1.341,07	56320 x 4	- 56010 x 5 - 56014 x 10		
4035	55550	958,65	56320 x 4	- 56011 x 3 - 56014 x 6	55587	1.160,86	56320 x 4	- 56011 x 4 - 56014 x 8	55624	1.362,76	56320 x 4	- 56011 x 5 - 56014 x 10		
4145	55551	958,34	56320 x 4	- 56010 x 3 - 56015 x 6	55588	1.160,44	56320 x 4	- 56010 x 4 - 56015 x 8	55625	1.362,24	56320 x 4	- 56010 x 5 - 56015 x 10		
4255	55552	971,41	56320 x 4	- 56011 x 3 - 56015 x 6	55589	1.177,56	56320 x 4	- 56011 x 4 - 56015 x 8	55626	1.383,82	56320 x 4	- 56011 x 5 - 56015 x 10		
4360	55553	1.001,60	56320 x 4	- 56014 x 9	55590	1.217,40	56320 x 4	- 56014 x 12	55627	1.434,03	56320 x 4	- 56014 x 15		
4470	55554	1.007,93	56320 x 4	- 56014 x 6 - 56015 x 3	55591	1.225,50	56320 x 4	- 56014 x 8 - 56015 x 4	55628	1.444,62	56320 x 4	- 56014 x 10 - 56015 x 5		
4580	55555	1.014,16	56320 x 4	- 56014 x 3 - 56015 x 6	55592	1.234,73	56320 x 4	- 56014 x 4 - 56015 x 8	55629	1.455,20	56320 x 4	- 56014 x 5 - 56015 x 10		
4690	55556	1.020,49	56320 x 4	- 56015 x 9	55593	1.243,13	56320 x 4	- 56015 x 12	55630	1.465,57	56320 x 4	- 56015 x 15		



Fondo - Width: 560 mm
Altura - Height: 1.750 mm

PP AL 75°C
Polipropileno Aluminio -30°C

Estantería completa
Rayonnage complet
Regale, komplett
Full shelving
Estantes completa

SIMPLE

DOBLE · DOUBLE

TRIPLE

3 Estantes - Shelf				4 Estantes - Shelf				5 Estantes - Shelf			
L (mm)	Ref	€	Desglose - Breakdown	Ref	€	Desglose - Breakdown	Ref	€	Desglose - Breakdown		
710	55709	304.92	57317 x 2 + 57007 x 3	55746	351.61	57317 x 2 + 57007 x 4	55783	399.23	57317 x 2 + 57007 x 5		
822	55710	311.35	57317 x 2 + 57008 x 3	55747	359.70	57317 x 2 + 57008 x 4	55784	409.71	57317 x 2 + 57008 x 5		
932	55711	323.60	57317 x 2 + 57009 x 3	55748	377.44	57317 x 2 + 57009 x 4	55785	431.39	57317 x 2 + 57009 x 5		
1037	55712	334.00	57317 x 2 + 57010 x 3	55749	418.01	57317 x 2 + 57010 x 4	55786	481.61	57317 x 2 + 57010 x 5		
1147	55713	367.38	57317 x 2 + 57011 x 3	55750	435.34	57317 x 2 + 57011 x 4	55787	503.08	57317 x 2 + 57011 x 5		
1257	55714	380.04	57317 x 2 + 57012 x 3	55751	452.14	57317 x 2 + 57012 x 4	55788	524.15	57317 x 2 + 57012 x 5		
1367	55715	392.59	57317 x 2 + 57013 x 3	55752	468.95	57317 x 2 + 57013 x 4	55789	545.21	57317 x 2 + 57013 x 5		
1472	55716	418.22	57317 x 2 + 57014 x 3	55753	502.98	57317 x 2 + 57014 x 4	55790	587.95	57317 x 2 + 57014 x 5		
1582	55717	430.87	57317 x 2 + 57015 x 3	55754	519.79	57317 x 2 + 57015 x 4	55791	608.60	57317 x 2 + 57015 x 5		
1719	55718	577.58	57317 x 3 + 57007 x 3 + 57010 x 3	55755	688.28	57317 x 3 + 57007 x 4 + 57010 x 4	55792	798.98	57317 x 3 + 57007 x 5 + 57010 x 5		
1829	55719	590.44	57317 x 3 + 57007 x 3 + 57011 x 3	55756	705.40	57317 x 3 + 57007 x 4 + 57011 x 4	55793	820.66	57317 x 3 + 57007 x 5 + 57011 x 5		
1939	55720	602.89	57317 x 3 + 57007 x 3 + 57012 x 3	55757	721.89	57317 x 3 + 57007 x 4 + 57012 x 4	55794	841.31	57317 x 3 + 57007 x 5 + 57012 x 5		
2046	55721	626.24	57317 x 3 + 57010 x 6	55758	754.16	57317 x 3 + 57010 x 8	55795	881.15	57317 x 3 + 57010 x 10		
2154	55722	641.38	57317 x 3 + 57007 x 3 + 57014 x 3	55759	773.35	57317 x 3 + 57007 x 4 + 57014 x 4	55796	905.12	57317 x 3 + 57007 x 5 + 57014 x 5		
2264	55723	653.00	57317 x 3 + 57007 x 3 + 57015 x 3	55760	790.05	57317 x 3 + 57007 x 4 + 57015 x 4	55797	926.18	57317 x 3 + 57007 x 5 + 57015 x 5		
2376	55724	665.14	57317 x 3 + 57010 x 3 + 57013 x 3	55761	805.20	57317 x 3 + 57010 x 4 + 57013 x 4	55798	944.96	57317 x 3 + 57010 x 5 + 57013 x 5		
2481	55725	690.46	57317 x 3 + 57010 x 3 + 57014 x 3	55762	839.13	57317 x 3 + 57010 x 4 + 57014 x 4	55799	987.60	57317 x 3 + 57010 x 5 + 57014 x 5		
2591	55726	703.53	57317 x 3 + 57010 x 3 + 57015 x 3	55763	856.04	57317 x 3 + 57010 x 4 + 57015 x 4	55800	1008.55	57317 x 3 + 57010 x 5 + 57015 x 5		
2701	55727	716.08	57317 x 3 + 57011 x 3 + 57015 x 3	55764	873.16	57317 x 3 + 57011 x 4 + 57015 x 4	55801	1030.24	57317 x 3 + 57011 x 5 + 57015 x 5		
2811	55728	729.05	57317 x 3 + 57013 x 3 + 57014 x 3	55765	890.18	57317 x 3 + 57013 x 4 + 57014 x 4	55802	1051.20	57317 x 3 + 57013 x 5 + 57014 x 5		
2916	55729	754.57	57317 x 3 + 57014 x 6	55766	924.21	57317 x 3 + 57014 x 8	55803	1093.94	57317 x 3 + 57014 x 10		
3026	55730	767.23	57317 x 3 + 57014 x 3 + 57015 x 3	55767	941.12	57317 x 3 + 57014 x 4 + 57015 x 4	55804	1115.00	57317 x 3 + 57014 x 5 + 57015 x 5		
3136	55731	779.79	57317 x 3 + 57015 x 6	55768	957.82	57317 x 3 + 57015 x 8	55805	1135.86	57317 x 3 + 57015 x 10		
3275	55732	925.14	57317 x 4 + 57010 x 6 + 57012 x 3	55769	1124.24	57317 x 4 + 57010 x 8 + 57012 x 4	55806	1322.50	57317 x 4 + 57010 x 10 + 57012 x 5		
3385	55733	937.69	57317 x 4 + 57010 x 6 + 57013 x 3	55770	1141.15	57317 x 4 + 57010 x 8 + 57013 x 4	55807	1343.46	57317 x 4 + 57010 x 10 + 57013 x 5		
3490	55734	963.32	57317 x 4 + 57010 x 6 + 57014 x 3	55771	1175.28	57317 x 4 + 57010 x 8 + 57014 x 4	55808	1386.62	57317 x 4 + 57010 x 10 + 57014 x 5		
3598	55735	977.64	57317 x 4 + 57007 x 3 + 57014 x 6	55772	1194.58	57317 x 4 + 57007 x 4 + 57014 x 8	55809	1410.27	57317 x 4 + 57007 x 5 + 57014 x 10		
3710	55736	989.15	57317 x 4 + 57011 x 6 + 57014 x 3	55773	1209.00	57317 x 4 + 57011 x 8 + 57014 x 4	55810	1429.88	57317 x 4 + 57011 x 10 + 57014 x 5		
3818	55737	1003.06	57317 x 4 + 57007 x 3 + 57015 x 6	55774	1228.09	57317 x 4 + 57007 x 4 + 57015 x 8	55811	1452.19	57317 x 4 + 57007 x 5 + 57015 x 10		
3925	55738	1027.13	57317 x 4 + 57010 x 3 + 57014 x 6	55775	1260.36	57317 x 4 + 57010 x 4 + 57014 x 8	55812	1492.96	57317 x 4 + 57010 x 5 + 57014 x 10		
4035	55739	1040.09	57317 x 4 + 57011 x 3 + 57014 x 6	55776	1276.95	57317 x 4 + 57011 x 4 + 57014 x 8	55813	1514.02	57317 x 4 + 57011 x 5 + 57014 x 10		
4145	55740	1052.34	57317 x 4 + 57010 x 3 + 57015 x 6	55777	1293.24	57317 x 4 + 57010 x 4 + 57015 x 8	55814	1535.60	57317 x 4 + 57010 x 5 + 57015 x 10		
4255	55741	1065.41	57317 x 4 + 57011 x 3 + 57015 x 6	55778	1310.78	57317 x 4 + 57011 x 4 + 57015 x 8	55815	1557.29	57317 x 4 + 57011 x 5 + 57015 x 10		
4360	55742	1090.83	57317 x 4 + 57014 x 9	55779	1344.70	57317 x 4 + 57014 x 12	55816	1599.93	57317 x 4 + 57014 x 15		
4470	55743	1103.38	57317 x 4 + 57014 x 6 + 57015 x 3	55780	1362.24	57317 x 4 + 57014 x 8 + 57015 x 4	55817	1620.89	57317 x 4 + 57014 x 10 + 57015 x 5		
4580	55744	1116.35	57317 x 4 + 57014 x 3 + 57015 x 6	55781	1378.63	57317 x 4 + 57014 x 4 + 57015 x 8	55818	1641.95	57317 x 4 + 57014 x 5 + 57015 x 10		
4690	55745	1128.80	57317 x 4 + 57015 x 9	55782	1395.75	57317 x 4 + 57015 x 12	55819	1662.91	57317 x 4 + 57015 x 15		

Il est possible d'acquiescer les articles de cette page.



Fondo - Width: 560 mm
Altura - Height: 2.000 mm

PP | **AL** | 75°C
Polypropylene | Aluminium

Estanteria completa

Rayonnage complet
Regale, komplett
Full shelving
Estantes completa.

SIMPLE

DOBLE · DOUBLE

TRIPLE

3 Estantes - Shelf

L (mm)	Ref	€	Desglose - Breakdown
710	55820	330.34	57320 x 2 + 57007 x 3
822	55821	336.36	57320 x 2 + 57008 x 3
932	55822	349.53	57320 x 2 + 57009 x 3
1037	55823	379.62	57320 x 2 + 57010 x 3
1147	55824	392.59	57320 x 2 + 57011 x 3
1257	55825	405.25	57320 x 2 + 57012 x 3
1367	55826	417.91	57320 x 2 + 57013 x 3
1472	55827	443.43	57320 x 2 + 57014 x 3
1582	55828	455.09	57320 x 2 + 57015 x 3

4 Estantes - Shelf

Ref	€	Desglose - Breakdown
55857	377.44	57320 x 2 + 57007 x 4
55858	385.74	57320 x 2 + 57008 x 4
55859	402.86	57320 x 2 + 57009 x 4
55860	443.22	57320 x 2 + 57010 x 4
55861	460.44	57320 x 2 + 57011 x 4
55862	477.46	57320 x 2 + 57012 x 4
55863	494.16	57320 x 2 + 57013 x 4
55864	528.30	57320 x 2 + 57014 x 4
55865	545.10	57320 x 2 + 57015 x 4

5 Estantes - Shelf

Ref	€	Desglose - Breakdown
55894	424.34	57320 x 2 + 57007 x 5
55895	435.02	57320 x 2 + 57008 x 5
55896	456.30	57320 x 2 + 57009 x 5
55897	506.72	57320 x 2 + 57010 x 5
55898	528.40	57320 x 2 + 57011 x 5
55899	549.46	57320 x 2 + 57012 x 5
55900	570.52	57320 x 2 + 57013 x 5
55901	612.13	57320 x 2 + 57014 x 5
55902	633.19	57320 x 2 + 57015 x 5

L (mm)	Ref	€	Desglose - Breakdown
1719	55829	614.62	57320 x 3 + 57007 x 3 + 57010 x 3
1829	55830	628.41	57320 x 3 + 57007 x 3 + 57011 x 3
1939	55831	640.14	57320 x 3 + 57007 x 3 + 57012 x 3
2046	55832	664.83	57320 x 3 + 57010 x 6
2154	55833	679.25	57320 x 3 + 57007 x 3 + 57014 x 3
2264	55834	691.60	57320 x 3 + 57007 x 3 + 57015 x 3
2376	55835	702.08	57320 x 3 + 57010 x 3 + 57013 x 3
2481	55836	727.81	57320 x 3 + 57010 x 3 + 57014 x 3
2591	55837	741.29	57320 x 3 + 57010 x 3 + 57015 x 3
2701	55838	754.26	57320 x 3 + 57011 x 3 + 57015 x 3
2811	55839	766.82	57320 x 3 + 57013 x 3 + 57014 x 3
2916	55840	792.44	57320 x 3 + 57014 x 6
3026	55841	805.20	57320 x 3 + 57014 x 3 + 57015 x 3
3136	55842	817.65	57320 x 3 + 57015 x 6

Ref	€	Desglose - Breakdown
55866	726.04	57320 x 3 + 57007 x 4 + 57010 x 4
55867	743.06	57320 x 3 + 57007 x 4 + 57011 x 4
55868	759.35	57320 x 3 + 57007 x 4 + 57012 x 4
55869	791.92	57320 x 3 + 57010 x 8
55870	811.12	57320 x 3 + 57007 x 4 + 57014 x 4
55871	828.03	57320 x 3 + 57007 x 4 + 57015 x 4
55872	842.97	57320 x 3 + 57010 x 4 + 57013 x 4
55873	877.10	57320 x 3 + 57010 x 4 + 57014 x 4
55874	893.91	57320 x 3 + 57010 x 4 + 57015 x 4
55875	911.13	57320 x 3 + 57011 x 4 + 57015 x 4
55876	928.04	57320 x 3 + 57013 x 4 + 57014 x 4
55877	962.07	57320 x 3 + 57014 x 8
55878	978.88	57320 x 3 + 57014 x 4 + 57015 x 4
55879	995.79	57320 x 3 + 57015 x 8

Ref	€	Desglose - Breakdown
55903	836.95	57320 x 3 + 57007 x 5 + 57010 x 5
55904	858.22	57320 x 3 + 57007 x 5 + 57011 x 5
55905	879.39	57320 x 3 + 57007 x 5 + 57012 x 5
55906	919.12	57320 x 3 + 57010 x 10
55907	942.98	57320 x 3 + 57007 x 5 + 57014 x 5
55908	964.05	57320 x 3 + 57007 x 5 + 57015 x 5
55909	982.72	57320 x 3 + 57010 x 5 + 57013 x 5
55910	1.025.36	57320 x 3 + 57010 x 5 + 57014 x 5
55911	1.045.53	57320 x 3 + 57010 x 5 + 57015 x 5
55912	1.068.00	57320 x 3 + 57011 x 5 + 57015 x 5
55913	1.089.17	57320 x 3 + 57013 x 5 + 57014 x 5
55914	1.131.91	57320 x 3 + 57014 x 10
55915	1.152.66	57320 x 3 + 57014 x 5 + 57015 x 5
55916	1.173.72	57320 x 3 + 57015 x 10

L (mm)	Ref	€	Desglose - Breakdown
3275	55843	975.67	57320 x 4 + 57010 x 6 + 57012 x 3
3385	55844	988.22	57320 x 4 + 57010 x 6 + 57013 x 3
3490	55845	1.013.85	57320 x 4 + 57010 x 6 + 57014 x 3
3598	55846	1.028.16	57320 x 4 + 57007 x 3 + 57014 x 6
3710	55847	1.039.78	57320 x 4 + 57011 x 6 + 57014 x 3
3818	55848	1.053.48	57320 x 4 + 57007 x 3 + 57015 x 6
3925	55849	1.077.76	57320 x 4 + 57010 x 3 + 57014 x 6
4035	55850	1.090.52	57320 x 4 + 57011 x 3 + 57014 x 6
4145	55851	1.102.66	57320 x 4 + 57010 x 3 + 57015 x 6
4255	55852	1.116.04	57320 x 4 + 57011 x 3 + 57015 x 6
4360	55853	1.141.35	57320 x 4 + 57014 x 9
4470	55854	1.154.01	57320 x 4 + 57014 x 6 + 57015 x 3
4580	55855	1.166.67	57320 x 4 + 57014 x 3 + 57015 x 6
4690	55856	1.179.33	57320 x 4 + 57015 x 9

Ref	€	Desglose - Breakdown
55880	1.174.87	57320 x 4 + 57010 x 8 + 57012 x 4
55881	1.191.67	57320 x 4 + 57010 x 8 + 57013 x 4
55882	1.225.70	57320 x 4 + 57010 x 8 + 57014 x 4
55883	1.244.27	57320 x 4 + 57007 x 4 + 57014 x 8
55884	1.260.36	57320 x 4 + 57011 x 8 + 57014 x 4
55885	1.277.99	57320 x 4 + 57007 x 4 + 57015 x 8
55886	1.310.78	57320 x 4 + 57010 x 4 + 57014 x 8
55887	1.328.21	57320 x 4 + 57011 x 4 + 57014 x 8
55888	1.344.50	57320 x 4 + 57010 x 4 + 57015 x 8
55889	1.361.10	57320 x 4 + 57011 x 4 + 57015 x 8
55890	1.395.75	57320 x 4 + 57014 x 12
55891	1.432.66	57320 x 4 + 57014 x 8 + 57015 x 4
55892	1.428.74	57320 x 4 + 57014 x 4 + 57015 x 8
55893	1.446.28	57320 x 4 + 57015 x 12

Ref	€	Desglose - Breakdown
55917	1.373.86	57320 x 4 + 57010 x 10 + 57012 x 5
55918	1.394.92	57320 x 4 + 57010 x 10 + 57013 x 5
55919	1.436.94	57320 x 4 + 57010 x 10 + 57014 x 5
55920	1.461.42	57320 x 4 + 57007 x 5 + 57014 x 10
55921	1.480.20	57320 x 4 + 57011 x 10 + 57014 x 5
55922	1.503.44	57320 x 4 + 57007 x 5 + 57015 x 10
55923	1.543.90	57320 x 4 + 57010 x 5 + 57014 x 10
55924	1.565.59	57320 x 4 + 57011 x 5 + 57014 x 10
55925	1.586.03	57320 x 4 + 57010 x 5 + 57015 x 10
55926	1.607.61	57320 x 4 + 57011 x 5 + 57015 x 10
55927	1.650.46	57320 x 4 + 57014 x 15
55928	1.671.52	57320 x 4 + 57014 x 10 + 57015 x 5
55929	1.692.27	57320 x 4 + 57014 x 5 + 57015 x 10
55930	1.713.43	57320 x 4 + 57015 x 15

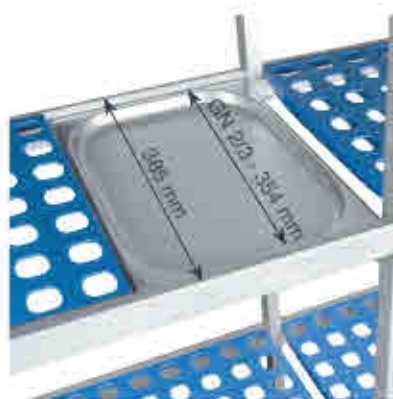

Fondo - Width: 385 mm
 Altura - Height: 1.750 mm

PP | **AL** | 75°C
 Polypropilena | Aluminium | -30°C

Estanteria abierta
 Rayonnage ouvertes
 Offenes Regale
 Open shelving
 Estantes abiertas

SIMPLE

3 Estantes - Shelf				4 Estantes - Shelf			5 Estantes - Shelf		
L (mm)	Ref	€	Desglose - Breakdown	Ref	€	Desglose - Breakdown	Ref	€	Desglose - Breakdown
682	55631	197,64	56317 x 1 + 56007 x 3	55640	238,31	56317 x 1 + 56007 x 4	55649	278,88	56317 x 1 + 56007 x 5
794	55632	204,08	56317 x 1 + 56008 x 3	55641	247,03	56317 x 1 + 56008 x 4	55650	289,88	56317 x 1 + 56008 x 5
904	55633	216,94	56317 x 1 + 56009 x 3	55642	263,84	56317 x 1 + 56009 x 4	55651	311,04	56317 x 1 + 56009 x 5
1009	55634	236,14	56317 x 1 + 56010 x 3	55643	289,57	56317 x 1 + 56010 x 4	55652	343,10	56317 x 1 + 56010 x 5
1119	55635	249,21	56317 x 1 + 56011 x 3	55644	306,79	56317 x 1 + 56011 x 4	55653	364,79	56317 x 1 + 56011 x 5
1229	55636	260,10	56317 x 1 + 56012 x 3	55645	321,31	56317 x 1 + 56012 x 4	55654	382,84	56317 x 1 + 56012 x 5
1339	55637	266,22	56317 x 1 + 56013 x 3	55646	329,72	56317 x 1 + 56013 x 4	55655	393,42	56317 x 1 + 56013 x 5
1472	55638	291,85	56317 x 1 + 56014 x 3	55647	363,85	56317 x 1 + 56014 x 4	55656	436,05	56317 x 1 + 56014 x 5
1554	55639	298,28	56317 x 1 + 56015 x 3	55648	372,46	56317 x 1 + 56015 x 4	55657	446,64	56317 x 1 + 56015 x 5



Fondo - Width: 385 mm
 Altura - Height: 2.000 mm

PP | **AL** | 75°C
 Polypropilena | Aluminium | -30°C

Estanteria abierta
 Rayonnage ouvertes
 Offenes Regale
 Open shelving
 Estantes abiertas

SIMPLE

3 Estantes - Shelf				4 Estantes - Shelf			5 Estantes - Shelf		
L (mm)	Ref	€	Desglose - Breakdown	Ref	€	Desglose - Breakdown	Ref	€	Desglose - Breakdown
682	55658	210,20	56320 x 1 + 56007 x 3	55667	250,75	56320 x 1 + 56007 x 4	55676	291,43	56320 x 1 + 56007 x 5
794	55659	216,94	56320 x 1 + 56008 x 3	55668	259,89	56320 x 1 + 56008 x 4	55677	302,54	56320 x 1 + 56008 x 5
904	55660	229,39	56320 x 1 + 56009 x 3	55669	276,60	56320 x 1 + 56009 x 4	55678	323,60	56320 x 1 + 56009 x 5
1009	55661	248,90	56320 x 1 + 56010 x 3	55670	302,22	56320 x 1 + 56010 x 4	55679	355,76	56320 x 1 + 56010 x 5
1119	55662	261,66	56320 x 1 + 56011 x 3	55671	319,45	56320 x 1 + 56011 x 4	55680	377,44	56320 x 1 + 56011 x 5
1229	55663	272,55	56320 x 1 + 56012 x 3	55672	333,04	56320 x 1 + 56012 x 4	55681	395,60	56320 x 1 + 56012 x 5
1339	55664	278,88	56320 x 1 + 56013 x 3	55673	342,38	56320 x 1 + 56013 x 4	55682	405,97	56320 x 1 + 56013 x 5
1472	55665	303,88	56320 x 1 + 56014 x 3	55674	376,51	56320 x 1 + 56014 x 4	55683	448,62	56320 x 1 + 56014 x 5
1554	55666	310,84	56320 x 1 + 56015 x 3	55675	385,02	56320 x 1 + 56015 x 4	55684	459,20	56320 x 1 + 56015 x 5

Illegale Kopieren
 - Verboten -



Fondo - Width: 560 mm
 Altura - Height: 1.750mm

PP AL 75°C
 Polypropilene Aluminium -30°C

Estanteria abierta

Rayonnage ouvertes
 Offenes Regale
 Open shelving
 Estantes abertas

SIMPLE

L (mm)	3 Estantes - Shelf			4 Estantes - Shelf			5 Estantes - Shelf		
	Ref	€	Desglose - Breakdown	Ref	€	Desglose - Breakdown	Ref	€	Desglose - Breakdown
682	55931	223,06	57317 x 1 + 57007 x 3	55940	270,37	57317 x 1 + 57007 x 4	55949	316,54	57317 x 1 + 57007 x 5
794	55932	229,39	57317 x 1 + 57008 x 3	55941	278,67	57317 x 1 + 57008 x 4	55950	327,12	57317 x 1 + 57008 x 5
904	55933	242,36	57317 x 1 + 57009 x 3	55942	295,79	57317 x 1 + 57009 x 4	55951	349,33	57317 x 1 + 57009 x 5
1009	55934	272,55	57317 x 1 + 57010 x 3	55943	336,05	57317 x 1 + 57010 x 4	55952	399,65	57317 x 1 + 57010 x 5
1119	55935	285,31	57317 x 1 + 57011 x 3	55944	353,48	57317 x 1 + 57011 x 4	55953	421,23	57317 x 1 + 57011 x 5
1229	55936	298,28	57317 x 1 + 57012 x 3	55945	369,14	57317 x 1 + 57012 x 4	55954	442,39	57317 x 1 + 57012 x 5
1339	55937	310,84	57317 x 1 + 57013 x 3	55946	386,99	57317 x 1 + 57013 x 4	55955	463,35	57317 x 1 + 57013 x 5
1472	55938	335,22	57317 x 1 + 57014 x 3	55947	421,12	57317 x 1 + 57014 x 4	55956	505,99	57317 x 1 + 57014 x 5
1554	55939	349,02	57317 x 1 + 57015 x 3	55948	437,93	57317 x 1 + 57015 x 4	55957	527,05	57317 x 1 + 57015 x 5

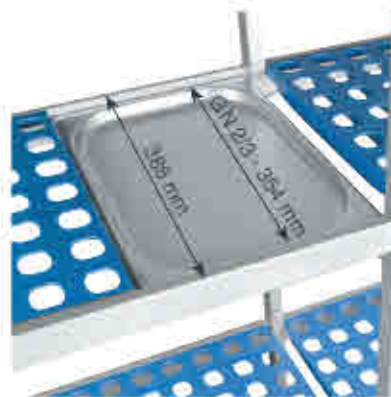

Fondo - Width: 560 mm
 Altura - Height: 2.000 mm

PP AL 75°C
 Polypropilene Aluminium -30°C

Estanteria abierta

Rayonnage ouvertes
 Offenes Regale
 Open shelving
 Estantes abertas

SIMPLE

L (mm)	3 Estantes - Shelf			4 Estantes - Shelf			5 Estantes - Shelf		
	Ref	€	Desglose - Breakdown	Ref	€	Desglose - Breakdown	Ref	€	Desglose - Breakdown
682	55958	235,72	57320 x 1 + 57007 x 3	55967	282,93	57320 x 1 + 57007 x 4	55976	329,41	57320 x 1 + 57007 x 5
794	55959	242,05	57320 x 1 + 57008 x 3	55968	291,12	57320 x 1 + 57008 x 4	55977	339,89	57320 x 1 + 57008 x 5
904	55960	255,02	57320 x 1 + 57009 x 3	55969	308,35	57320 x 1 + 57009 x 4	55978	361,05	57320 x 1 + 57009 x 5
1009	55961	285,00	57320 x 1 + 57010 x 3	55970	348,70	57320 x 1 + 57010 x 4	55979	412,30	57320 x 1 + 57010 x 5
1119	55962	298,28	57320 x 1 + 57011 x 3	55971	366,03	57320 x 1 + 57011 x 4	55980	433,78	57320 x 1 + 57011 x 5
1229	55963	310,84	57320 x 1 + 57012 x 3	55972	382,84	57320 x 1 + 57012 x 4	55981	454,84	57320 x 1 + 57012 x 5
1339	55964	323,29	57320 x 1 + 57013 x 3	55973	399,65	57320 x 1 + 57013 x 4	55982	475,90	57320 x 1 + 57013 x 5
1472	55965	349,02	57320 x 1 + 57014 x 3	55974	433,68	57320 x 1 + 57014 x 4	55983	518,44	57320 x 1 + 57014 x 5
1554	55966	361,67	57320 x 1 + 57015 x 3	55975	450,59	57320 x 1 + 57015 x 4	55984	539,60	57320 x 1 + 57015 x 5



Cestas
Racks

#CocinaConLacor

▶ CESTAS

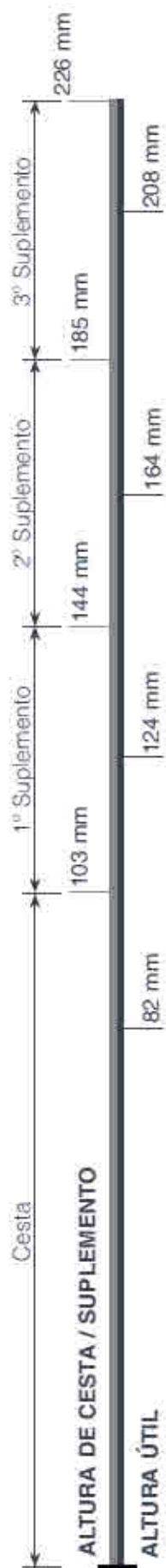



Cesta Base

Casier universel
Spülkorb
Universal open rack
Cesta base

Ref	€	cm	U.Venta
69235	30.81	35x35x12	1
69240	31.54	40x40x11	1

PP

Polypropilena



La alta calidad de sus materiales hacen que la resistencia al calor y a los impactos sea óptima, por lo que su durabilidad está garantizada. Su sistema único de apilación permite un fácil montaje, y lo que es más novedoso, el desmontaje del mismo siempre que usted lo desee. Su estructura abierta permite una mayor rapidez en el lavado y secado, debido a una mejor circulación de agua y del aire. El diseño de las asas hacen que su manejo y carga sean cómodos y sin riesgos. Además, para facilitar su manejo, está disponible un carro porta cestas útil para evitar esfuerzos en los desplazamientos. Adaptable a la mayoría de las cestas existentes en el mercado.

The high quality of the materials used in this range give total protection against heat and shocks and thus guarantees durability. The unique folding system enables racks to be constructed and dismantled at will. The open structure enables a better circulation of both water and air for an easier wash and dry. The handle design makes loading and transport easy and risk-free. As an option a dolly is available to assist in the handling of racks. This product is compatible with the majority of other dishwasher baskets on the market.

Cesta Base Universal

Casier universel
Universalspülkorb
Universal open rack
Cesta base universal



Ref	€	cm	U.Venta
69250	23.45	50x50x10,3	1

Suplemento altura abierta

Réhausse sans compart.
Ergänzung
Universal open extender
Suplem. altura abierto



Ref	€	cm	U.Venta
69251	9.75	50x50x4,5	1

Cesta base 16 compartimentos

Casier 16 compartiments
Spülkorb 16-tlg.
Rack with 16 compartments
Cesta base 16 compart.



Ref	€	cm	U.Venta
69214	28.01	50x50x10,3	1

Suplem. altura 16 compartimentos

Réhausse, 16 comp.
Ergänzung 16-tlg. Spülkorb
Extender for rack with 16 compart.
Suplem. altura 16 compart.



Ref	€	cm	U.Venta
69217	11.93	50x50x4,5	1

Cesta base 25 compartimentos

Casier 25 compartiments
Spülkorb 25-tlg.
Rack with 25 compartments
Cesta base 25 compart.



Ref	€	cm	U.Venta
69225	29.57	50x50x10,3	1

Suplem. altura 25 compartimentos

Réhausse, 25 comp.
Ergänzung 25-tlg. Spülkorb
Extender for rack with 25 compart.
Suplem. altura 25 compart.



Ref	€	cm	U.Venta
69226	12.76	50x50x4,5	1

Cesta base 36 compartimentos

Casier 36 compartiments
Spülkorb 36-tlg.
Rack with 36 compartments
Cesta base 36 compart.



Ref	€	cm	U.Venta
69236	31,02	50x50x10,3	1

Suplem. altura 36 compartimentos

Réhausse, 36 comp.
Ergänzung 36-tlg. Spülkorb
Extender for rack with 36 compart.
Suplem. altura 36 compart.



Ref	€	cm	U.Venta
69237	12,76	50x50x4,5	1

Cesta base 49 compartimentos

Casier 49 compartiments
Spülkorb 49-tlg.
Rack with 49 compartments
Cesta base 49 compart.



Ref	€	cm	U.Venta
69249	31,96	50x50x10,3	1

Suplem. altura 49 compartimentos

Réhausse, 49 comp.
Ergänzung 49-tlg. Spülkorb
Extender for rack with 49 compart.
Suplem. altura 49 compart.



Ref	€	cm	U.Venta
69248	13,59	50x50x4,5	1

Cesta para platos

Casier pour assiettes
Tellerspülkorb
Small trays and dishes rack
Cesta para pratos



Ref	€	cm	U.Venta
69202	23,55	50x50x10,3	1

Cesta para platos

Casier pour assiettes
Tellerspülkorb
Small trays and dishes rack
Cesta para pratos



Ref	€	cm	U.Venta
69234	31,33	35x35x12	1
69241	36,83	40x40x11	1

Cesta para platos / bandejas

Casier pour grands platex
Plattenspülkorb
Universal open side trays rack
Cesta Pratos/Bandejas



Ref	€	cm	U.Venta
69203	29,05	50x50x10,3	1

Soporte para platos

Support pour les plats
Tellerhalter
Plate holder
Suporte para pratos



Ref	€	cm	U.Venta
69207	9,03	31,0x9,5x7(15)	1
69213	10,48	34,5x9,5x7(17)	1

Cesta para cubiertos

Casier à couverts
Besteckspülkorb
Flatware/utensil rack
Cesta para talheres



Ref	€	cm	U.Venta
69204	23,14	50x50x10,3	1

Tapa cesta universal

Couvercle pour casier universel
Deckel für Universals Spülkorb
Standard rack's lid
Tampa cesta universal



Ref	€	cm	U.Venta
69205	18,47	50x50x2,5	1

Cesta 8 compart. Cubiertos

Panier à couverts, 8 compart.
Besteckspülkorb 8 f.g.
Cutlery rack with 8 compart.
Cesta 8 compart. talheres



Ref	€	cm	U.Venta
69208	14,53	20,5x43x13	1

Cubilete cubiertos

Petit panier à couverts
Besteckbehälter
Cutlery cube
Cesta talheres



Ref	€	cm	U.Venta
69215	4,46	12,5x12,5x13,5	6

**Carro porta-cestas**

Socle à roulettes pour casier
Transportwagen fuer Spuelkoerbe
Trolley for racks
Carro porta-cestas

Ref	€	cm	U.Venta	
69211	183,22	55x57x80	1	Con asa With handle
69212	111,64	55x57x20	1	Sin asa Without handle

A hand is shown reaching towards a white, wall-mounted hand sanitizer dispenser. The dispenser is sleek and modern, with a black top and bottom edge. The background is a blurred kitchen with wooden cabinets and a window showing greenery outside. A semi-transparent white box is overlaid on the right side of the image, containing text.

Limpeza
Cleaning

#CocinaConLacor

▶ DISPENSADORES DE JABÓN/GEL

New

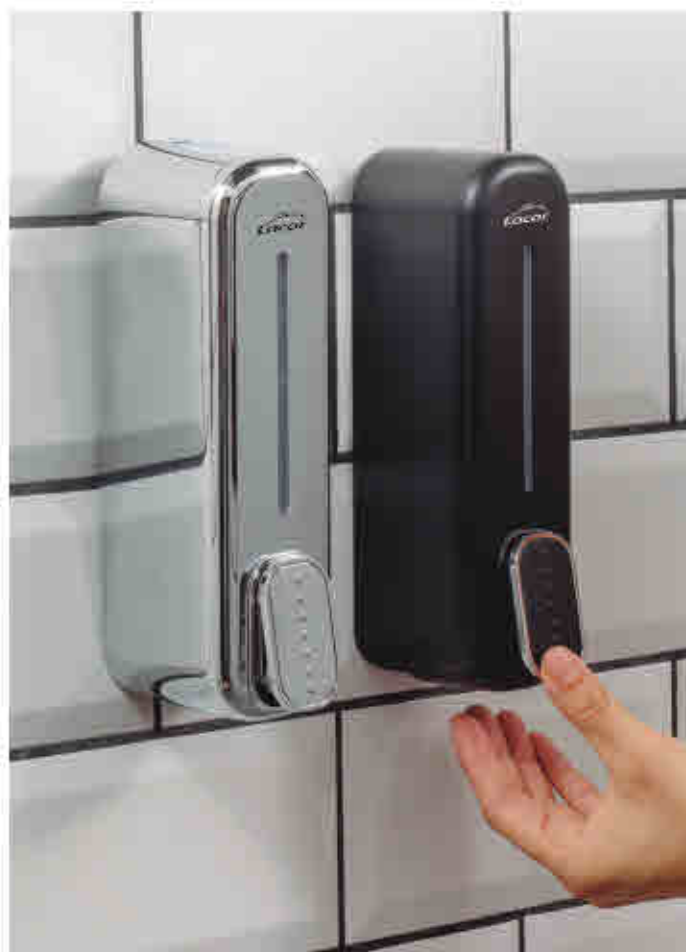

Dispensador manual de jabón y gel.

Perfecto para almacenar y dispensar geles desinfectantes, jabones, champús u otros materiales líquidos.
Tamaño compacto, ideal para oficinas, hogares, restaurantes, etc.
Ventana transparente que permite controlar la cantidad de líquido disponible.
Diseñado para colocar en la pared y ahorrar espacio.
Depósito extraíble para rellenar fácilmente.

Distributeur manuel de savon et gel.

Parfait pour accueillir et distribuer du gel, du désinfectant, du savon, du shampooing, ou tout autre élément liquide.
Taille compacte, idéale pour les bureaux, la maison, les restaurants, etc.
Fenêtre transparente qui permet de contrôler la quantité de liquide disponible.
Conçu pour être installé sur un mur et ainsi gagner de l'espace.
Réservoir extractible pour un remplissage facile.

Handspender für Seife und Gel.

ideal zum Vorhalten und Ausgeben von Desinfektionsgel, Seife, Shampoo oder anderen Flüssigkeiten.
Kompaktes Design, ideal für Büro, Haushalt, Restaurant usw.
Füllstand durch Sichtfenster erkennbar.
Platzsparende Wandmontage.
Herausnehmbarer Behälter ist leicht nachfüllbar.

Manual soap and gel dispenser.

Perfect for storing and dispensing disinfectant gel, soap, shampoo or other liquids.
Compact size, ideal for home, office, restaurants, etc.
It has a transparent window so you can see how much liquid is available.
It is designed for installing on the wall and to save space.
Removable container for easy refilling.

Dispensador manual de sabão líquido e gel

ideal para armazenar e dispensar geles desinfetantes, sabões, champôs e outros produtos líquidos.
Tamanho compacto, ideal para oficinas, lares, restaurantes, etc.
Visor transparente que permite controlar a quantidade de líquido disponível.
Concebido para colocar na parede e poupar espaço.
Depósito extraível e fácil de encher.



Fácil de rellenar
Easy to fill



ABS PE
Plastic Polyethylene

Dispensadores de jabón / gel
Distributeur de savon et gel
Seifen- und Gelspender
Soap and gel dispenser
Dispensador de sabão e gel

	Ref	€	L	Color	U.Venta
A	91520	10,27	0,350	Cromado - Chrome	1
B	91521	9,23	0,350	Negro - Black	1

ABS SAN
plastic plastic

Dispensadores de jabón / gel WHITE
Distributeur de savon et gel
Seifen- und Gelspender
Soap and gel dispenser
Dispensador de sabão e gel

	Ref	€	L	U.Venta
	91525	20,65	1,10	1



▶ DISPENSADORES AUTOMÁTICOS Y SOPORTE



Dispensador Dispenser		Soporte Support
ABS	PE	FE
Plastic	Polyethylene	Iron

Permite ubicar el dispensador de gel en cualquier lugar, sin necesidad de depender de ninguna pared o superficie vertical. (Ref. 91540)
Apto para gel hidroalcohólico y jabón líquido.
Funcionamiento con sensor, detección entre 5 - 9 cm de altura.
Opción de ajustar el caudal entre 0,5 y 2,5 ml.
Ideal para zonas de gran movimiento de gente.
Posibilidad de comprar el soporte solo o con el dosificador de gel.

Permet d'installer le distributeur de gel n'importe où, sans avoir besoin d'un mur ou d'une surface verticale. (Ref. 91540)
Apté pour du gel hydroalcoolique et du savon liquide.
Fonctionnement avec capteur, détection de 5 à 9 cm de hauteur.
Option de réglage du débit de 0,5 à 2,5 ml.
Idéal pour des zones de grand passage.
Possibilité d'acheter le support seul ou avec le flacon doseur de gel.

Der Ständer ermöglicht, Gelspender an beliebigen Orten aufzustellen, auch ohne Wände oder vertikale Flächen. (Ref. 91540)
Für keimtötendes Gel mit Alkohol und Flüssigseife.
Sensorsteuerung funktioniert ab 5-8 cm Handdistanz.
Ausgabemenge zwischen 0,5 ml und 2,5 ml einstellbar.
Ideal für stark frequentierte Bereiche.
Ständer ist separat oder mit Gelspender erhältlich.

Lets you put a gel dispenser anywhere without needing to rely on any walls or vertical surfaces. (Ref. 91540)
Can be used with hydroalcoholic gel or liquid soap.
Works using a sensor that can detect at a height of 5 cm to 9 cm.
The flow can be adjusted from 0.5 ml to 2.5 ml.
Perfect for areas with a lot of human traffic.
The support is sold separately or with the gel dispenser.

Permite situar o dispensador de gel hidroalcohólico em qualquer lugar, sem necessidade de dispor de uma parede ou superfície vertical. (Ref. 91540)
Apto para gel hidroalcohólico e sabonete líquido.
Funcionamento por sensor, com detecção entre 5 - 9 cm de altura.
Caudal regulável entre 0,5 e 2,5 ml.
Ideal para zonas de grande movimento de pessoas.
Possibilidade de comprar só o suporte ou incluir o dispensador de gel.



Posibilidad de colocar en pared
Possibility of wall mounting



Fácil de rellenar
Easy to fill



Cierre con llave
Lockable with a key

Funcionan con 4 pilas
AA (No incluidas)
Uses 4 AA batteries
(not included)

Dispensadores automáticos de jabón/gel
Distributeur automatique de savon et gel
Automatischer Seifen- und Gelspender
Automatic soap and gel dispenser
Dispensador automático de sabão e gel

	Ref.	€	ml	cm	U.Venta
A	91522	68,79	850	11x12x26	1 SILVER
B	91523	68,79	850	11x12x26	1 WHITE

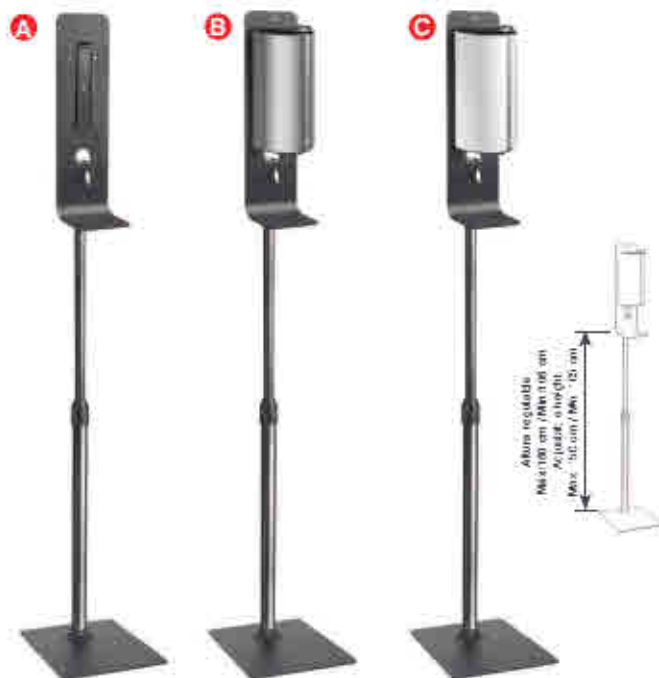

Soporte dispensador de gel
Support distributeur de gel
Gelspenderhalter
Gel dispenser holder
Suporte dispensador de gel

	Ref.	€	h (cm)	U.Venta
A	91540	61,21	160	1 Soporte - Support
B	91541	128,34	160	1 Sop. + SILVER - Support + SILVER
C	91542	128,34	160	1 Sop. + WHITE - Support + WHITE

▶ GEL HIDROALCOHÓLICO / HIGIENIZANTE

New



GEL HIGIENIZANTE
Liquid Liquid



Geles y soluciones hidroalcohólicas.

Especialmente diseñados para higienización rápida y eficaz de las manos (91515-91511-91505).

Acción suavizante y dermo protectora, confiere a las manos un tacto suave y agradable.

No requiere el empleo de agua, jabón, ni toalla.

Sin espesante. Ideales para superficies (91516-91517).

Rapidez de aplicación y secado. Efecto refrescante.

Higienizante, bactericida, fungicida y virucida de secado rápido (91516-91517).

Gel et solution hydroalcoolique.

Spécialement conçus pour une désinfection rapide et efficace des mains (91515-91511-91505)

Action adoucissante et dermo-protectrice, conférant un toucher doux et agréable aux mains

Né requièrent pas l'utilisation d'eau, ni de savon, ni de serviette

Sans épaississant. Parfaits pour surfaces (91516-91517)

Rapidité d'application et de séchage. Effet rafraîchissant.

Désinfectant, bactéricide, fongicide et virucide à séchage rapide (91516-91517)

Gel/Lösung mit Alkohol

Eigens entwickelt, um die Hände schnell und wirkungsvoll zu reinigen (91515-91511-91505)

Hautfreundlich, macht die Haut weich und geschmeidig

Ohne Wasser, Seife oder Handtuch anwendbar

Ohne Verdickungsmittel. Ideal für die Oberflächen (91516-91517)

Schnelle Anwendung. Trocknet schnell. Frischewirkung

Schnell trocknendes Desinfektionsmittel, Bakterizid, Fungizid und Viruzid (91516-91517)

Hydroalcoholic gel and solution

Specially designed to quickly and effectively hygienise your hands (91515-91511-91505)

Softening and dermo-protective action gives your hands a nice soft touch

Does not require water, soap or a towel

No thickeners. Perfect for surfaces (91516-91517)

Fast application and drying. Refreshing feeling

Meets standards (UNE EN 1500, 14476, 13727 and 13824)

Hygienising, bactericidal, fungicidal, virucidal and quick drying (91516-91517)

Gel e solução hidroalcoólico.

Especialmente concebido para uma higienização rápida e eficaz das mãos (91515-91511-91505)

Ação suavizante e dermoprotetora, confere às mãos um tacto suave e agradável

Não requer o uso de água, sabão nem toalha

Sem espessantes. Ideais para superfícies (91516-91517)

Rapidez de aplicação e secagem. Efeito refrescante

Higienizante, bactericida, fungicida e virucida de secagem rápida (91516-91517)



Gel hidroalcohólico de manos

Gel hydroalcoolique pour les mains

Gel mit Alkohol Handgel

Hydroalcoholic hand gel

Gel de mão hidroalcoólico

70%
Alcohol
Isopropílico

	Ref	€	L	U.Venta
A	91515	8,82	0,5	1
B	91511	14,42	1,0	1
C	91505	70,03	5,0	1

Higienizante de superficies

Désinfectant pour les surfaces

Desinfektionsmittel für Oberflächen

Hygienising for surfaces

Higienizante para superficies

75%
Alcohol
Isopropílico

	Ref	€	L	U.Venta
A	91517	11,00	0,5	1
B	91516	69,51	5,0	1

▶ SECADOR DE MANOS



Inox
18/10

Secador de manos con pulsador

Sèche-mains à bouton
Händetrockner mit Knopf
Hand dryer with pusher
Secador de mão com botão

Ref	€	W	cm	U.Venta
69501	299,20	2300	26x15x23	1

Ref	Tensión/Voltage	Potencia/Power	Veloc. aire/Air speed	Dist. acción/Action dist.	Dimensiones/Sizes	Peso/Weight
69501	220-240 V: 50 Hz	2300 W	19 m/s	50 - 200 mm	26x15x23 cm	4,50 Kg

Para montaje en pared (recomendable a unos 110 cm del suelo).
Ideal para instalar en baños como en cocinas o vestuarios.
Compacto, robusto y especialmente higiénico.
Tiempo de secado ajustable.
Sistema de apagado automático (tiempo máximo 30 seg).
Protección del medio ambiente evitando toallas de papel.

Pour montage sur mur (recommandé à environ 110 cm du sol).
Idéal pour installer aussi bien dans des salles de bain que dans des cuisines ou des vestiaires.
Compact, robuste et particulièrement hygiénique.
Durée de séchage réglable.
Système d'arrêt automatique (durée maximum 30 s).
Protection de l'environnement en évitant l'utilisation de serviettes en papier.

Zur Wandmontage (empfohlen ca. 110 cm über dem Boden).
Ideal für die Installation in Badezimmer wie Küchen oder Umkleiskabinen.
Kompakt, robust und besonders hygienisch.
Einstellbare Trocknungszeit.
Automatisches Abschaltssystem (maximale Zeit 30 Sekunden).
Schutz der Umwelt durch Vermeidung von Papiertüchern.

Designed for wall mounting (recommended height around 110 cm from the floor).
Perfect for installing in bathrooms, kitchens or dressing rooms.
Compact, robust and extremely hygienic.
Adjustable drying time.
Automatic shut-off system (maximum time 30 sec).
Protects the environment by not using paper towels.

Para montagem na parede (recomendado a cerca de 110 cm do solo).
Ideal para instalar em casas de banho como cozinhas ou vestiários.
Compacto, robusto e particularmente higiénico.
Tempo de secagem ajustável.
Sistema de desligamento automático (tempo máximo de 30 segundos).
Proteger o meio ambiente evitando toalhas de papel.

▶ PAPELERAS CON PEDAL

Container
Inox
PP
Polypropylene

New



Ideal para baños de hoteles, restaurantes y todo tipo de establecimientos.
Práctica, compacta y funcional. Apertura de tapa mediante pedal.
Sistema de cierre de tapa con freno; la tapa se cierra suave y silenciosamente.
Cubeta interior extraíble de polipropileno con asa. Pies antideslizantes.

Perfect for hotel bathrooms, restaurants and all kinds of businesses.
Practical, compact and functional. The lid opens using a pedal.
Cover closure system with brake. The lid closes smoothly and silently.
It has a removable polypropylene inner liner with a handle. Non-slip feet.



Papelera con pedal

Poubelle à pédale
Tret-Abfallbehälter
Pedal bin
Papeleira com pedal

Ref	€	Ø (cm)	h (cm)	L	Color	U.Venta
63306	19,92	16,8	25	3,0	GREY	1
63307	19,92	16,8	25	3,0	WHITE	1
63309	19,92	16,8	25	3,0	BLACK	1

Papelera con pedal

Poubelle à pédale
Tret-Abfallbehälter
Pedal bin
Papeleira com pedal

Ref	€	Ø (cm)	h (cm)	L	U.Venta
63303	18,99	17,0	25,5	3,0	1
63305	24,90	20,5	28,0	5,0	1
63312	36,73	25,0	40,0	12,0	1
63319	62,71	29,0	45,0	20,0	1



DISPENSADOR



Ajustable hasta 45 cm de ancho
Adjustable up to 45 cm wide



Doble cuchilla; cuchilla deslizante y cuchilla dentada
Double blade; sliding blade and serrated blade



Posibilidad de anclarlo en la pared
Possibility to anchor it on the wall



Dispensador de film o papel aluminio

Distributeur de film ou de papier d'aluminium
Folien- oder Alu-Folienspendler
Film or aluminium foil dispenser
Dispensador de filme ou folha de alumínio

Ref	€	cm	U.Venta
60704	63,08	56,5x20x16,5	1



New

Práctico e higiénico, ideal para tiendas, bares, restaurantes, panaderías, carnicerías, pescaderías, etc.

Doble cuchilla: Cuchilla deslizante para el corte del film transparente y aluminio. Cuchilla dentada para el corte del film de aluminio (incluida en el interior de la tapa).

Ambas cuchillas proporcionan un corte limpio y preciso con máxima seguridad. Cuenta con 4 tacos antideslizantes para evitar su desplazamiento a la hora de extraer el film o papel de aluminio.

Diseñado para utilizarlo en la encimera o anclado en la pared (incluye tacos y tornillos).

Pratique et hygiénique, idéal pour les magasins, les bars, les restaurants, les boulangeries, les boucheries, les poissonneries, etc.

Double lame: Lame coulissante pour couper le film transparent et l'aluminium. Lame dentelée pour couper le film d'aluminium (inclus à l'intérieur du couvercle). Les deux lames offrent une découpe propre et précise avec une sécurité maximale. Dispose de 4 pieds antidérapants pour éviter son déplacement lors de l'extraction du film alimentaire ou du papier aluminium. Conçu pour être installé sur le plan de travail ou fixé au mur (inclut des vis et des chevilles).

Praktisch und sauber, ideal für Läden, Bars, Restaurants, Bäckereien, Metzgereien, Fischverkäufer usw.

Doppelklinge: Gleitschneider zum Schneiden von transparenter Folie und Aluminium. Gezackte Klinge zum Schneiden von Aluminiumfolie (im Deckel enthalten). Beide Klingen macht einen sauberen und genauen Schnitt mit maximaler Sicherheit. Verfügt über 4 Anrutschdübel, damit der Helfer bei Entnahme der Frischhalte- oder Aluminiumfolie nicht verrutscht. Konzipiert zum Gebrauch auf der Arbeitsfläche oder an der Wand (Dübel und Schrauben im Lieferumfang enthalten).

It's practical and hygienic and perfect for shops, bars, restaurants, bakeries, butchery shops, fish mongers, etc.

Double blade: Sliding blade for cutting transparent film and aluminium. Serrated blade for cutting aluminium film (included inside the lid). Both blades provide a makes a clean and precise cut with maximum safety. It has four non-slip pads to keep it from sliding when film or aluminium foil is pulled out. It's designed to be used on a counter or anchored to a wall (screws and rawlplugs included).

Prático e higiénico, ideal para estabelecimentos comerciais, bares, restaurantes, peçarias, talhos, peixarias, etc.

Lâmina dupla: Lâmina deslizante para cortar o filme transparente e o alumínio. Lâmina serrilhada para cortar filme de alumínio (incluída dentro da tampa). Ambas as lâminas proporcionam um corte limpo e preciso, com a máxima segurança. 4 patas antidescizantes, que evitam qualquer movimento ao extrair o filme, ou o papel de alumínio. Concebido para ser utilizado em cima da bancada, ou fixo à parede (inclui tacos e parafusos).

Compatible para bobinas de film o aluminio de hasta 45 cm ancho

Compatible for film or aluminum reels up to 45 cm wide



Bobina aluminio

Rouleau aluminium
Aluminiumfolie
Aluminium foil
Bobina alumínio

Ref	€	Film (m)	Caja (cm)	Micras (µm)	U.Venta
10330	47,52	0,30x300	10x35	11	1
10430	58,31	0,40x300	10x42	11	1



Bobina film transparente

Rouleau film transparent
Frischhaltefolie
Transparent cling film
Bobina filme transparente

Ref	€	Film (m)	Caja (cm)	Micras (µm)	U.Venta
11330	12,14	0,30x300	10x33	10	1
11430	18,78	0,45x300	10x48	10	1

▶ PORTARROLLOS · LIMPIEZA

A



Inox
18/10

Portarrollos de cocina de pared

Dériveur de cuisine
Küchenrollenspender
Multiroll dispenser for kitchen
Porta-rollos cozinha de parede

	Ref	€	U.Venta
A	60701	60,53	6
B	60702	47,73	8

B



Rollos aptos para los portarrollos - Rolls suitable for multiroll dispenser

Ref	Film transparente/Transparent Film	Rollo aluminio/Aluminium foil	Rollo papel/ Paper roll
60701	Ø50x320 mm	Ø50x320 mm	Ø180x330 mm
60702	Ø48x340 mm	Ø60x340 mm	Ø170x330 mm



Base contrapeso:
Base contre-poids
Späner-Belastung
Counterweight base
Base contrapeso: **1 Kg**

Inox
18/10

Pie portarrollos

Dériveur verticale pour papier essuie-tout
Spänder für Küchenrolle
Kitchen roll dispenser stand
Pé porta-rolos

Ref	€	Ø (cm)	h (m)	U.Venta
50301	17,12	15	32,5	6



Personalización para cantidades

Personnalisation pour des quantités
Individuelle Gestaltung bei Abnahme
Customization for quantities
Personalização para quantidades
>500 Unid

Delantal de algodón

Tablier en coton
Schürze, Baumwolle
Cotton Pinalore
Avental de algodão

Ref	€	U.Venta
10004	10,38	1



Inox

Servilletero Bar

Distributeur de serviettes bar
Serviettenspender
Bar napkin holder
Guardanapo bar



Ref	€	cm	Servilleta	U.Venta
61001	11,21	8,5x12	90x125	1

Inox

Servilletero Bar

Distributeur de serviettes bar
Serviettenspender bar
Bar napkin holder
Guardanapo bar



Ref	€	cm	Servilleta	U.Venta
61002	8,09	9,5x13,5	90x125	4

Inox
18/10



Papelera sobremesa

Poubelle de table
Tisch-Abfallbehälter
Table bin
Papeteira de mesa

Ref	€	Ø (cm)	h (cm)	L	U.Venta
63302	20,75	12	16	1,20	1

Inox
18/10



Cepillo recoge-migas

Ramasse-miettes à rouleaux
Krümelbürste
Crumbs cleaner
Escova apanha-migalhas

U.Venta

Ref	€	cm	h (cm)	U.Venta
64407	12,65	9,5x16,5	4,0	1



Inox
18/10



Cepillo recogedor HIPERLUXE

Ramasse-miettes à rouleaux HIPERLUXE
Krümelbürste, HIPERLUXE
HIPERLUXE crumbs cleaner
Escova apanha-migalhas HIPERLUXE

Ref	€	cm	U.Venta
64408	42,75	14,5x17	1



Inox
18/10



Cepillo recogedor LUXE

Ramasse-miettes LUXE
Krümelbürste, LUXE
LUXE crumbs cleaner
Espátula apanha-migalhas LUXE

Ref	€	cm	U.Venta
64409	27,08	22x7	1



AL FU

Aluminium Fundido/Cast

Rasqueta Profesional para grill

Racloir Professionnel pour grill
Professioneller grillschaber
Professional grill scraper
Raspador Profesional para grill

Ref	€	cm	L Cuchilla (cm)	U.Venta
67034	60,80	42x15x12	15	1



Fabricada en una sola pieza de aluminio fundido.
Cuchillas de acero inoxidable intercambiables.
Se utiliza para raspar los residuos de los alimentos y el carbón de las planchas.
Ergonómico gracias a los dos puntos de sujeción.
Protección contra salpicaduras de residuos durante la limpieza.

Fabriquée en une seule pièce en fonte d'aluminium.
Lames en acier inoxydable interchangeable.
Utilisée pour raclez les résidus des aliments et le charbon des planches.
Ergonomique grâce aux deux points de prise en main.
Protection contre les éclaboussures de résidus pendant le nettoyage.

Made of a single piece of cast aluminium.
Interchangeable stainless steel blades.
Used to scrape food and charcoal residue from grills.
Ergonomic design with two hand-holds.
Splash guard to prevent residue from splashing upward during cleaning.

POSTES SEPARADORES BLACK

New



FE

Iron

Ideal para la gestión de colas o separación de espacios.
Estructura fabricada en hierro con recubrimiento de color negro.
Cinta extensible retráctil de 2 m de longitud.
Fácil de fijar y soltar las conexiones.

Idéal pour la gestion de files d'attente ou la séparation d'espaces.
Structure fabriquée en métal, recouverte de couleur noire.
Sangle extensible rétractable de 2 m de longueur.
Facilité de fixation et de détachement des connexions.

Idéal für die Verwaltung von Warteschlangen oder zur Trennung von Räumen.
Struktur aus schwarz beschichtetem Eisen.
2 m langes einziehbares Stretchband.
Einfaches Anbringen und Lösen von Verbindungen.

Perfect for managing queues or separating spaces.
Iron structure with black coating.
2 m long extendible retractable belt.
The connections are easy to attach and release.

Idéal para a gestão de filas e separação de espaços.
Estrutura fabricada em ferro com revestimento de cor preta.
Fita extensível retrátil de 2 m de comprimento.
Conexões fáceis de fixar e de soltar.

Ideal para gestionar colas o separación de espacios

Perfect for queue management or space separation

Dispone de 2 conexiones
Permite conectar cintas para crear áreas separadas
 2 connections for connecting belts from other posts

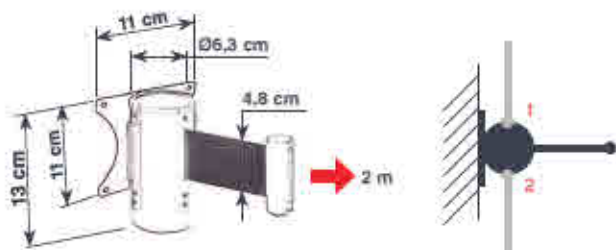

Fijación en pared
 Wall fixing



Separador pared BLACK

Séparateur mural
 Wandtrennpfosten
 Wall separator
 Separador de parede

Ref	€	metros	U.Venta	
A 91530	32,37	2	1	(Incluye R91533A) (Included)
B R91533A	1,56	-	1	(Apto para la ref. 91530 - suitable for ref.91530)

Dispone de 3 conexiones
Permite conectar cintas para crear áreas separadas
 3 connections for connecting belts from other posts

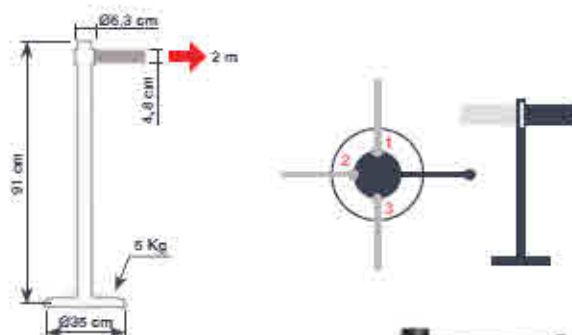

Poste separador BLACK

Poteau séparateur
 Trennpfosten
 Separator post
 Poste separador

Ref	€	metros	U.Venta
91533	49,49	2	1



► CENICEROS EXTERIORES



Cenicero pared INOX

Mural cendrier
Wand aschenbecher
Wall ash try
Cinzeiro de parede

Ref	€	cm	h (cm)	U.Venta
63341	75,53	24,5x35	14	1

Inox
18/10

Ceniceros para pared exterior.
Cerradura con llave.
Incluye material para fijación y una llave triangular.
Cajetín interior de acero galvanizado extraíble para facilitar su limpieza.

Cendrieres pour mur extérieur.
Fermeture à clé.
Comprend le matériel de fixation et une clé triangulaire.
Boîtier intérieur en acier galvanisé extraîble pour faciliter son nettoyage.

Aschenbecher für Außenwände
Mit Schlüssel verschließbar.
Material zur Befestigung an der Wand und Dreieckschlüssel im Lieferumfang enthalten.
Innenfach aus verzinktem Stahl herausnehmbar, um die Reinigung zu erleichtern.

Outdoor wall ashtray.
Lock with key.
Includes attachment elements and triangular key.
Removable galvanized steel inner box for easy cleaning.

Cinzeiros de parede para exteriores.
Fechadura com chave.
Inclui material para a sua fixação e uma chave triangular.
Compartimento interior em aço galvanizado, extível para facilitar a sua limpeza.



Cenicero pared BLACK

Mural cendrier
Wand aschenbecher
Wall ash try
Cinzeiro de parede

Ref	€	cm	h (cm)	U.Venta
63342	70,86	25x35	8,5	1

Cenicero redondo de pared

Cendrier extérieur mural rond
Wand Aschenbecher round
Wall round ash try
Cinzeiro de parede redondo

Ref	€	Ø (cm)	L	U.Venta
63331	79,06	8x46	1,70	1



Cenicero redondo de pie

Ronde cendrier
Stand Aschenbecher round
Stand round ash try
Cinzeiro de pie redondo

Ref	€	Ø (cm)	L	U.Venta
63332	126,37	8x92	1,50	1







REPOSTERÍA PASTRY

Preparación
Pastry Processing

Moldes · Aros
Moulds · Cake Rings

JARRAS MEDIDORAS



Inox
18/10



Jarra de medidas cónica

Pot mesureur
Messbecher
Measuring cup
Jarra de medidas cónica

Ref	€	L	U.Venta
57010	30,92	1,00	1

Inox
18/10



Jarra 5 litros

Pot en inox 5 L
Kanne 5 Ltr.
5 L pitcher
Jarra 5 L

Ref.	€	Ø (cm)	L	U.Venta
62750	65,16	17x22,5	5,00	1

PP



Polypropylene



Jarra medidora

Pot mesureur
Messbecher
Measuring jug
Jarra de medidas

Ref	€	ml	U.Venta
67136	4,25	500	1

SAN



Plastic



Juego 3 jarras medidoras

Ensemble de 3 pot mesureur
3-tlg. Satz Messbecher
3 piece measuring jugs
Jogo 3 jarras de medidas

Ref	€	ml	U.Venta
67131	12,97	250-500-1000	1



Vidrio borosilicato
Borosilicate glass

100% higiénica
100% hygienic



Vidrio



Glass

Microwave

Jarra medidora de cristal

Pot mesureur en verre
Messbecher aus Glas
Glass measuring jug
Jarra de medidas de vidrio

Ref	€	L	U.Venta
67133	9,44	0,5	1



PMMA



Plastic

Jarra medidora SPIN

Pot mesureur
Messbecher
Measuring jug
Jarra de medidas

Ref	€	L	U.Venta
67165	10,06	0,5	1
67161	11,41	1,0	1



Sist. de lectura rápida en milímetros y cups
Easily readable markings in millimeters and cups

Inox
18/10



Fuente honda cónica

Bassine pâtisseries
Schüssel, tief, konisch
Deep and conical dish
Bacia alta cónica

Ref	€	Ø (cm)	h (cm)	L	U.Venta
60013	10,48	13	6,1	0,55	1
60016	11,31	16	9,1	1,00	1
60020	15,67	20	11,7	2,12	1
60024	18,78	24	12,6	3,50	1
60028	23,55	28	13,4	5,25	1
60032	26,15	32	15,0	7,65	1
60036	36,62	36	16,0	11,00	1
60040	42,43	40	18,0	15,00	1

Inox



Bot cónico

Boî conique
Schüssel, konisch
Conical mixing bowl
Bacia cónica



Ref	€	Ø (cm)	h (cm)	L	U.Venta
14016	3,22	16	6,5	0,90	12
14019	4,46	20	7,5	1,40	12
14025	8,09	24	9,0	2,50	1
14029	10,89	30	11,0	4,30	1
14033	15,15	34	13,5	7,50	1

▶ CAZOS / CUCHARAS MEDIDORAS



Inox
18/10

Jgo. de 5 cucharas medidoras

Ensemble de 5 cuillères à doser
Messlöffel-Set 5 Tig.
5 piece measuring set
Jogo de 5 colheres de medidas



Ref	€	ml	U.Venta
67001	9,23	0,62/1,25/2/5/15	1

Graduadas y marcadas en ml y cups
Marked and graduated in ml and cups

New

Inox PP
Polipropileno

Juego 4 cucharas medidoras

Ensemble de 4 cuillères à doser
Messlöffel-Set 4 Tig.
Measuring cup 4 piece
Jogo de 4 colheres de medidas



Ref	€	ml	U.Venta
67037	3,53	1,25/2,5/5/15	1

Inox
18/10

Jgo. de 4 cazos de medidas

Ensemble de 4 dosettes
Mass-Pfännchen-Set 4 Tig.
Measuring cup 4 pieces
Jogo caçaroles de medidas



Ref	€	ml	U.Venta
67007	10,06	60/80/125/250	4

Graduadas y marcadas en ml y cups

Pequeña hendidura en un lado para facilitar el vertido

A small spout on one side makes pouring easy
Marked and graduated in ml and cups

New

ABS
Plastic

Juego 5 cazos medidores

Ensemble de 5 dosettes à doser
Mass-Pfännchen-Set 5 Tig.
Measuring cup 5 piece
Jogo de 5 caçaroles de medidas



Ref	€	ml	U.Venta
67036	5,29	60/80/120/180/235	1

Inox
18/10

Librador
Pelle à farine
Mehlschaufel
Ice shovel
Corredor



Ref	€	ml	L (cm)	A (cm)	U.Venta
67012	15,25	60	19,0	5,0	6
67013	17,74	110	21,5	6,0	6
67014	20,96	200	24,0	7,0	6
67016	23,34	260	25,5	8,5	6
67017	25,83	360	29,0	10,0	6
67018	27,91	470	31,0	11,0	6
67019	34,76	640	35,0	12,5	6
67020	41,60	860	38,0	14,0	6

PC
Polycarbonato

Librador
Pelle à farine
Mehlschaufel
Ice shovel
Corredor



Ref	€	ml	Mango (cm)	U.Venta
A 67021	4,98	170	12	1
B 67022	10,17	900	12	1
C 67023	14,01	1800	14	1



Cuchara medidora digital

Cuillère avec Balance Digital
Digitale Löffelwaage
Digital spoon scale
Colher de pesar Digital



Ref	€	g	L (cm)	U.Venta
62519	34,24	300 (Div.0,10 g)	28	1



Cedazo

Tamis
Mehlsieb
Sieve
Peneira

Hilos por pulgada - Wires/inch: 50		
Ref	€	Ø (cm)
68052	23,34	12
68056	28,12	15
68058	33,41	18
68050	36,62	20
68057	50,73	26
68053	61,21	30
68054	83,52	40

Hilos por pulgada - Wires/inch: 35		
Ref	€	Ø (cm)
68350	33,62	20
68357	50,63	26
68351	57,27	30
68354	85,70	40

Hilos por pulgada - Wires/inch: 25		
Ref	€	Ø (cm)
68250	33,30	20
68252	50,32	26
68253	55,92	30
68254	86,53	40

Hilos por pulgada - Wires/inch: 20		
Ref	€	Ø (cm)
68026	52,60	26
68023	58,62	30
68024	88,40	40



50 orificios/pulgada
50 eyes/inch
Cuadrado: 0,35x0,35 mm
Square: 0,35x0,35 mm



35 orificios/pulgada
35 eyes/inch
Cuadrado: 0,50x0,50 mm
Square: 0,50x0,50 mm



25 orificios/pulgada
25 eyes/inch
Cuadrado: 0,75x0,75 mm
Square: 0,75x0,75 mm



20 orificios/pulgada
20 eyes/inch
Cuadrado: 1x1 mm
Square: 1x1 mm



Cedazo 4 mallas intercambiables

Tamis à 4 mailles interchangeables
4 Austauschbare Masche-Sieb
Mesh sieve interchangeable
Peneira de 4 malha intercambiáveis

Ref	€	Ø (cm)	U.Venta
68340	28,43	20	1
68341	34,24	23	1
68342	42,54	25	1

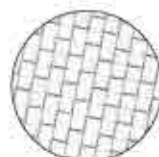

9 orificios/pulgada - 9 eyes/inch
Cuadrado - Square: 2x2 mm
Ø Varilla - Rod: 0,40 mm

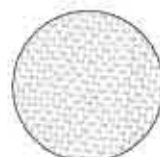

20 orificios/pulgada - 20 eyes/inch
Cuadrado - Square: 1x1 mm
Ø Varilla - Rod: 0,27 mm

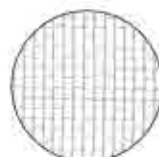

12 orificios/pulgada - 12 eyes/inch
Cuadrado - Square: 1,35x1,35 mm
Ø Varilla - Rod: 0,35 mm



40 orificios/pulgada - 40 eyes/inch
Cuadrado - Square: 0,7x0,7 mm
Ø Varilla - Rod: 0,12 mm

Inox

20 orificios/pulgada - 20 eyes/inch

Cribador de harina

Tamis
Mehlsieb
Flour sifter
Cribador de farinha

Ref	€	Ø (cm)	Kg	U.Venta
67011	9,03	10,0	0,35	5
67015	12,14	12,0	0,50	1



Se acciona con el mecanismo que incorpora en el asa en forma de gatillo.
Se puede utilizar con chocolate en polvo, levaduras, etc.

Fonctionne grâce au mécanisme intégré dans sa poignée en forme de gâchette.
Peut être utilisé avec du chocolat en poudre, des levures, etc.

Die Betätigung erfolgt über den im Griff integrierten Drückmechanismus.
Kann mit Schokoladenpulver, Hefe usw. verwendet werden.

It is activated with the trigger-shaped mechanism on the handle.
It can be used with powdered chocolate, yeast, etc.

Aciona-se com o mecanismo que incorpora na asa, em forma de gatilho.
Podá utilizar-se com chocolate em pó, leveduras, etc.

ASA

Acrylic



Cribador de harina

Tamis
Mehlsieb
Flour sifter
Cribador de farinha

Ref	€	Ø (cm)	Kg	U.Venta
67025	6,12	10	0,35	5



BATIDORES

Inox
18/10



Batidor MINI Inox

Mini fouet inox
Mini-Schneebeesen
Mini whisk
Mini.batedor inox

Ref	€	L (cm)	U.Venta
61615	4,67	15	1
61620	5,19	20	1



Batidor EXTRA 8

Fouet inox extra 8
Schneebeesen, Extra 8
Extra 8 whisk
Batedor Extra 8

Ref	€	L (cm)	U.Venta
61625	7,47	25	12
61630	7,57	30	12
61635	7,99	35	12
61640	8,82	40	12
61645	9,44	45	12
61650	10,69	50	12
61655	11,21	55	12
61660	12,14	60	12



Batidor SUPER 12

Fouet inox super 12
Schneebeesen, super 12
Super 12 whisk
Batedor Super 12

Ref	€	L (cm)	U.Venta
61626	6,85	25	12
61631	7,37	30	12
61636	7,99	35	12
61641	8,40	40	12
61646	8,72	45	12
61651	9,44	50	12



Batidor Gigante

Fouet à purées
Kesselbeesen
Big whisk
Batedor gigante

Ref	€	L (cm)	U.Venta
60610	53,74	100	1
60612	58,79	129	1



Si

Silicone



Batidor de varillas con raspador de silicona

Fouet avec grattoir en silicone
Schneebeesen mit Silikon-schaber
Whisk with built-in silicone
Batedeira de varas com raspador de silicone

Ref	€	L (cm)	U.Venta
61627	5,50	32	1



New

2 en 1
Bate y recoge toda la mezcla
del bol de forma fácil y rápida

2 in 1
Beat and scrape out the entire mixture
from the bowl quickly and easily



Batidor de varillas
Ø varilla : 2 mm
Roo whisk
Ø rood: 2 mm

Espátula
Spatula

Batidor FIBREGLASS

Fouet FIBREGLASS
FIBREGLASS Schneebeesen
FIBREGLASS Whisk
Batedores FIBREGLASS

Ref	€	L (cm)	U.Venta
61624	10,38	25	1
61629	11,93	30	1
61634	13,49	35	1
61639	14,94	40	1
61644	17,85	45	1
61649	18,76	50	1



Ergonómico
Ergonomic



Batidor silicona FIBREGLASS

Fouet en silicone FIBREGLASS
FIBREGLASS Schneebeesen, Silikon
FIBREGLASS silicone whisk
Batedores silicona FIBREGLASS

Ref	€	L (cm)	U.Venta
61524	9,44	25	1
61529	10,27	30	1
61534	11,93	35	1
61539	12,45	40	1



Ergonómico
Ergonomic



SI

250°C



Silicone

max

Batidor varilla silicona

Fouet en silicone
Rührbeesen auf Silikon
Silicone wire whisk
Batedor vareta silicone

Ref	€	L (cm)	U.Venta
61621	7,06	20	12
61622	7,78	25	12
61623	8,72	30	12

Inox

Batidor manivela

Batteur melangeur à manivelle
Schneequirl
Egg beater
Batedor de manivela

Ref	€	U.Venta
62901	16,39	6



ABS
plástico

SAN
plástico

Varillas Inox
Rods Inox

Batidor Capuccino

Batteur pour Cappuccino
Cappuccino-Mixer
Capuccino mixer
Batedor capuccino

Ref	€	W	U.Venta
69041	22,51	2,7	1



▶ RODILLOS

Inox
18/10

(A) LONGITUD TOTAL - Total length
(B) LONGITUD ZONA DE USO - Length area of use

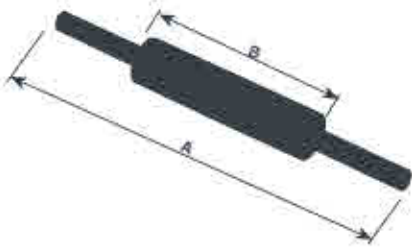

Rodillo
Rouleau pâtisier
Teigroller
Rolling pin
Rolo

Ref	€	A (cm)	B (cm)	U.Venta
67140	36,11	40	20	3
67148	40,26	48	25	4
67156	43,06	56	33	4

Rodillo
Rouleau pâtisier
Teigroller
Rolling pin
Rolo

Ref	€	A (cm)	B (cm)	U.Venta
67141	36,21	40	20	3
67149	41,81	48	25	4

PE
Polyetileno



Rodillo de amasar
Rouleau à pâtisserie
Teigroller
Rolling pin
Rolo de amasar

Ref	€	Ø (cm)	L (cm)	U.Venta
68141	30,61	4,4	43,0	1
68151	37,45	4,8	50,0	1

HAYA
Wood



Rodillo de madera de Haya
Rouleau pâtisier en hêtre
Teigroller, Buchenholz
Beechwood rolling pin
Rolo de madeira de faia

Ref	€	Ø (cm)	L (cm)	U.Venta
68142	8,30	4,4	43	1
68150	8,82	4,8	50	1

HAYA
Wood



Rodillo de madera de Haya con mango
Rouleau pâtisier en hêtre a/poignée
Teigroller, Buchenholz
Beechwood rolling pin with handle
Rolo de madeira de faia com cabo

Ref	€	A (cm)	B (cm)	U.Venta
68153	9,44	50	30	1
68154	17,85	60	40	1

HAYA PP
Wood - Polipropileno

Rodillo amasar con anillas
Rouleau hêtre avec anneau
Teigroller mit Ringen
Rolling pin with guide rings
Rolo com anilhas

Ref	€	Anillas	L (cm)	U.Venta
67142	13,18	10/6/2	38	1



Discos extraíbles.
Consigue masa de distinto grosor.
Grabado en la madera / inoxidable. Guía para medir el ancho de la masa.

Disques extraçibles.
Obtenez des masses d'épaisseurs différentes.
Gravé dans le bois / inox, un Guide pour mesurer la largeur de la masse

Austauschbare Ringe ermöglichen verschiedene Teigdicken
Im Holz / Edelstahl eingraviertes Lineal zum Messen der Teigbreite

Removable discs you can achieve a mass of different thicknesses.
There is a mass thickness measuring guide engraved in the wood / wood / stainless steel

Discos extraíveis.
Obtenha massa de distinta grossura.
Gravado na madeira / inoxidável. Guia para medir a largura da massa

Inox PP
Polipropileno

Rodillo amasar con anillas
Rouleau inox avec anneau
Teigroller mit weinring
Rolling pin with guide rings
Rolo com anilhas

Ref	€	Anillas	L (cm)	U.Venta
67143	15,70	10/6/3/2	38	1



New

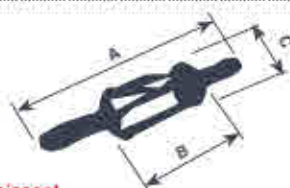
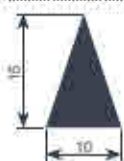

Rodillo cortador Croissant
Rouleau pour coupe Croissant
Schneidwalze für Croissantteig
Croissant dough cutter wheel
Rolo cortador de croissants

Ref	€	A (cm)	B (cm)	C (Ø cm)	U.Venta
68151	28,74	40,5	15,3	7,7	1



Rodillo picar pasta
Rouleau piqué vite pointe metal
Teig-Gitterschneider
Rofler docker metal
Rolo de picar massas

Ref	€	L (cm)	U.Venta
68213	31,33	13	6



RASQUETAS

Inox
18/10

Rasqueta
Coupe pate
Schaufel
Scraper
Raspador



	Ref	€	cm	U.Venta
A	67005	11.21	15x9	6
B	67006	10.79	15x9	6



Inox

Rasqueta
Coupe pate
Schaber
Scraper
Raspador



Escala de medición
Measurement scale

	Ref	€	cm	U.Venta
	67029	8.20	16,5x11	6



Amasa, corta, limpia y decora.
Indispensables a la hora de trabajar con masas.
Nos ayudan tanto a moverlas en el amasado como cortarlas gracias a su filo.
Gran ayuda a la hora de limpiar la superficie de trabajo eliminando los restos.

Pétrir, aplatir, nettoyer et décorer.
Indispensables lorsque l'on travaille avec la masse.
Il nous aide à la fois à se déplacer dans la pétrissage et la coupe de pointe grâce à son.
Grande aide lors du nettoyage de la surface de travail en enlevant des restes.

Kneten, schneiden und reinigen.
Unverzichtbar beim Kneten und Schneiden der Masse.
Große Hilfe beim Reinigen der Arbeitsfläche durch Entfernen der Überreste.

Knead, short, cleaning and decorate.
Indispensable when working with mass.
We help both move in the kneading and cutting edge thanks to its.
Great help when cleaning the working surface by removing debris.

Amassa, short, limpeza e decora.
Indispensáveis quando se trabalha com massa.
Nos ajudamos tanto movimento ou amassamento a corta graças à sua pontia.
Grande ajudaao limpar a superfície de trabalho remoção de detritos.



Rasqueta decoración
Grattoir à pâte
Teigschaber
Dough scrape
Raspador de masa

	Ref	€	mm	U.Venta
	68132	1.45	155x105	24



SI 230°C
Silicone max.

Rasqueta silicona
Coupe pate en Silicone
Schaufel, Silikon
Silicone scraper
Raspador silicone



	Ref	€	cm	U.Venta
	67414	7.78	9x15	1



Peine decoración
Peigne du decoration
Verzierungskamm
Decorating comb
Pente de decoração

	Ref	€	mm	U.Venta
	68136	1.25	110	24



ABS
Plástico

Estacas decoración Fondant
Outils de modelisation de Fondant
Fondant Modellierset
Fondant modeling tools
Ferramentas demodelagen Fondant

	Ref	€	Piezas	U.Venta
	68090	9.65	12	1



Juego peines decoración
Set peigne du decoration
Verzierungskamm-Set
Decorating comb set
Jogo pente de decoração

	Ref	€	Piezas	U.Venta
	68137	4.98	7	1



▶ ESPÁTULAS / PINCELES SILICONA



Para cocina o repostería.
Prácticas espátulas o lenguas de gato para rebañar boles, cazuelas, fuentes, etc.
Pinceles ideales para pincelar con aceites o salsas, marinar carnes o pescados, engrasar moldes, untar con aceite, huevo batido, almibar, etc.
No absorben olores ni sabores.

Pour la cuisine ou la pâtisserie.
Pratiques spatules ou langues de chats pour récupérer les éléments restant dans les bols, casseroles, etc.
Pinceaux parfaits pour badigeonner de l'huile ou des sauces, mariner des viandes ou des poissons, graisser des moules, étaler de l'huile, de l'œuf battu, du sirop, etc.
N'absorbent ni les odeurs ni les goûts.

Zum Kochen oder Backen.
Praktische Spachtel oder Schaber zum auskratzen von Schalen, Kasserollen, Schüsseln, etc.
Pinsel ideal zum Einstreichen mit Öl, Sauce, Marinieren von Fleisch oder Fisch.
Einfeilen von Backformen, zum Einölen, zum Bestreichen mit Ei oder Sirup usw.
Nehmen weder Geschmack noch Geruch an.

For cooking or baking.
Practical spatulas for scraping bowls, pots, dishes, etc.
Brushes ideal for brushing oils or sauces, marinating meat or fish, greasing baking tins, and basting with oil, egg, syrup, etc.
Doesn't absorb smells or tastes.

Para cozinha ou pasteleria.
Prácticas espátulas ou linguas de gato para barrar boles, caçarolas, formas e travessas, etc.
Pinceles ideais para pincelar com óleos ou molhos, marinar carnes ou peixes, untar formas, untar com óleo, ovo batido, calda, etc.
Não absorvem odores nem sabores.



Espátula Silicona
Spatule en silicone
Teigschaber
Silicone spatula
Espátula de silicone

	Ref	€	L (cm)	U.Venta
	64450	4,82	25	6
A	64451	7,78	35	6
	64450	5,08	25	6
B	64461	8,51	35	6

Espátula Silicona
Spatule en silicone
Teigschaber
Silicone spatula
Espátula de silicone

Ref	€	L (cm)	U.Venta
67434	4,05	30	12
67435	4,67	29	12



Espátula Silicona
Spatule en silicone
Teigschaber
Silicone spatula
Espátula de silicone

	Ref	€	L (cm)	U.Venta
A	64444	5,08	28	1
B	64445	5,71	30	1
C	64446	5,81	31	1

Inox
18/10
Mangon Mangon

Espátula Silicona
Spatule en silicone
Teigschaber
Silicone spatula
Espátula de silicone

Ref	€	L (cm)	U.Venta
67421	3,94	20	1
67427	3,91	26	1
67433	12,97	32	1





Utensilios de silicona GREY

Utensiles en silicone
Silikonutensilien
Silicone utensils
Utensilios de silicone

	Ref	€	L (cm)	U.Venta	
A	64463	4,46	27,5	1	Cuchara Spoon
B	64464	4,36	27,5	1	Espátula Spatula
C	64465	4,36	27,5	1	Pincel Brush



New

Fabricadas en silicona de alta calidad libre de BPA.
Núcleo metálico interior para mayor resistencia sin perder flexibilidad en los bordes.
Resistentes a altas temperaturas.
Mango ergonómico suave al tacto y antideslizante.
Diseñados en una sola pieza, sin costuras ni grietas.
No rayan ni dañan artículos de cocina con antiadherente.

Fabriquées en silicone de haute qualité sans BPA.
Noyau métallique intérieur pour une résistance accrue sans perte de flexibilité des bords.
Résistant aux hautes températures.
Poignée ergonomique, douce au toucher et antidérapante.
Conception monobloc, sans coutures ni fissures.
Ne raye pas et n'endommage pas les ustensiles de cuisine antiadhésifs.

Made of high quality BPA free silicone.
Inner metal core improves strength without losing flexibility around the edges.
Can withstand high temperatures.
Soft and non-slip ergonomic handle.
Designed in a single piece without seams or cracks.
Does not scratch cooking utensils with non-stick coating.

Pincel de Silicona

Pinceau en silicone
Silikonpinsel,
Silicon brush
Pincel de silicone

Ref	€	L (cm)	U.Venta
64441	5,81	23	1



Pincel virola Inox mango Polipropileno

Pinceau pâtisier V. inox M. Polypropylène
Fett-/Kuchenpinsel mit Stiel aus Polypropylen, schaft Edelstahl
Flat pastry brush s.steel Polypropylene handle
Pincel aro Inox cabo polietileno

Ref	€	L (cm)	Cerdas(cm)	U.Venta
64430	3,74	23,0	4,4x3,0	1
64435	4,36	24,0	4,4x3,5	1
64440	4,57	24,5	4,4x4,0	1
65044	3,60	25,0	5,0x4,5	1
65050	5,64	26,0	5,0x5,0	1



Dimensiones Reales - Real Dimensions



Pincel de silicona mango Inox

Pinceau de cuisine embout en silicone
Silikonpinsel, länger stiel
Silicone brush st. steel long handle
Pincel de silicone cabo Inox 18/10

Ref	€	L (cm)	U.Venta
A 64425	5,81	24	12
B 64431	6,23	24	12



Inox 18/10 230°C max

Pincel de Silicona Inox 18/10

Pinceau en silicone Inox 18/10
Silikonpinsel, Rostfrei 18/10
St. steel 18/10 silicon brush
Pincel silicone inox 18/10

Ref	€	L (cm)	U.Venta
A 64418	9,34	22	1
B 64422	10,58	23	1
C 64438	11,62	24	1



Set repostería (20 pcs.)

Exposant pâtisserie
Aufsteller Pastry
Pastry display
Expositor pastelería

Ref	€	L (cm)	Pieza	U.Venta
A 64424	66,09	-	Caja (20 pcs./Set/20 pcs)	1
B 64426	3,32	23,0	Pincel / Brush	12
C 64427	3,32	23,0	Espátula / Spatula	12
D 64428	3,32	23,0	Lengua gato / Spatula	12
E 64429	3,32	23,0	Batidor / Whisk	12



Preparación Rep.
Pastry Preparation

CORTAPASTAS



Inox
18/10

Perfectos para cortar todo tipo de masas de galletas, hojaldres, fondant o mazapan. Ideal para pastelería y repostería.
Permiten homogeneidad, dar el tamaño uniforme a los postres.

Parfait pour couper toutes sortes de pâte à biscuits, pâte feuilletée, fondant ou pâte d'amande. Idéal pour pâtisserie et pâtisserie.
Permettre l'homogénéité, donner une taille uniforme aux desserts.

Perfekt zum Schneiden aller Arten von Keksteig, Blätterteig, Fondant oder Marzipan. Ideal für Bäckerei und Konditorei.
Ermöglichen Sie Homogenität, geben Sie den Desserts eine einheitliche Größe.

Perfect for cutting all kinds of cookie dough, puff pastry, fondant or marzipan.
Ideal for pastry and pastry.
Allow homogeneity, give uniform size to desserts.

Perfeito para cortar todos os tipos de massa de biscoito, massa folhada, fondant ou maçaopão. Ideal para pasteleria e pastelaria.
Permitir homogeneidade, dar tamanho uniforme às sobremesas.

Caja de 9 cortapastas redondos

Boîte de 9 découpoirs ronds unis
9 TLG. Teigausstecher, rund, glatt
Set of 9 round dough cutters
Caixa de 9 corta-massas ovais redondos



Ref	€	h (cm)	U.Venta
68069	23,76	4,2	1 Liso - Plain
68070	25,94	4,2	1 Rizado - Fluted

Medidas

Sizes (cm): Ø2 / Ø3 / Ø4 / Ø5 / Ø6 / Ø7 / Ø8 / Ø9 / Ø10

Cerrado - Closed: 5,5x24 cm
Abierto - Open: 49,5x24 cm
Cuchilas - Blades: Ø5,5 cm



Inox

Cortapastas extensibles 5 ruedas

Rouleau multicoupe 5 roulettes en Inox 18% Cr.
Teigschneider, Edelstahl 18% Cr
S. steel 18% Cr dough divider expandable
Corta-massas extensível 5 rodas

Ref	€	U.Venta
68246	43,99	1

PA

40°C



Nylon

max



Caja de 9 cortapastas redondos

Boîte de 9 découpoirs ronds unis
9 TLG. Teigausstecher, rund, glatt
Set of 9 round dough cutters
Caixa de 9 corta-massas ovais redondos

Ref	€	h (cm)	U.Venta
68091	21,58	3,50	1 Liso - Plain
68092	21,58	3,50	1 Rizado - Fluted

Medidas

Sizes (cm): Ø2 / Ø3 / Ø4 / Ø5 / Ø6 / Ø7 / Ø8 / Ø9 / Ø10

Sierra sueca 3 cortes

Scie à gâteaux 3 lames
Kuchensäge 3-Messer
3 blades swedish saw
Serra.suexa 3 lâminas



Ref	€	cm	U.Venta
68515	116,62	53x23	1

- ✿ Hoja - Leaf
- ✿ Osito - Teddy bear
- ✿ Ángel - Angel
- ✿ Muñeco nieve - Snowman
- ✿ Palote - Candy cane
- ✿ Abeto - Christmas tree
- ✿ Campanilla - Bell
- ✿ Adorno - Decoration

Set 8 cortadores galletas

Set 8 emporte-pièces
8-Tig. Ausstechformen
Cookies cutters set
Set 8 cortadores de biscoito



Ref	€	Ø (cm)	Forma	U.Venta
68087	14,11	5	Navidades - Christmas	1

▶ SELLOS ESTAMPA GALLETAS

Dale un toque original
Add a touch of originality



Conjunto de 5 originales sellos de silicona intercambiables.
Mango de madera para un perfecto agarre.
Silicona de máxima calidad.
Garantiza la completa seguridad alimentaria del producto.

Set de 5 tampons en silicone originaux interchangeables.
Manche en bois pour une prise en main parfaite.
Silicone de la plus grande qualité.
Garantit une sécurité alimentaire totale du produit.

5-teiliges Stempelset mit austauschbaren Silikonaußensätzen.
Mit handlichem Holzgriff!
Sehr hochwertiges Silikon.
Garantiert die vollständige Lebensmittelsicherheit des Produkts.

Set of 5 original interchangeable silicon stamp
Wood handle for perfect grip.
Top quality silicone.
Guarantees complete food safety of the end product.

Conjunto de 5 originais carimbos de silicone intercambiáveis.
Pega de madeira para melhor sujeição.
Silicone da máxima qualidade.
Garante uma completa segurança alimentar do produto.



Incluye cortapastas
Includes cookie cutter



Sellos para galletas SWEET

Tampons pour biscuits
Keksstempel
Biscuit stamp
Carimbos para bolachas

Ref.	€	Sellos	U. Venta
68099	11,41	5	1

▶ PISTOLA GAS



Inox
18/10



Autoencendido por Piezoeléctrico
Control ajustable de llama
Llama antiretorno
Sistema seguro de bloqueo
Fácil relleno de gas butano

Auto allumage par piézoélectrique
Contrôle de flamme réglable
Flamme antiretour
Système de blocage sécurisé
Facile remplissage de gaz butane

Selbsttätige piezoelektrische Zündung
Einstellbare Flamme
Anti-Rückschlag-Flamme
Sicherheitsverriegelung
Einfache Butangas-Nachfüllung

Auto power by piezoelectric sensor
Adjustable flame control
Non-return flame
Safe stop system
Easy filling of butane gas

Autoignição piezoelétrica
Controlo de chama ajustável
Chama anti-retorno
Sistema seguro de bloqueio
Fácil de encher com gás butano



Pistola Gas repostería

Torche à caraméliser
Gasbrenner
Pastry Gas Torch
Queimadora a Gás para pastelaria

	Ref	€	Cap. (ml)	h (cm)	U.Venta
A	68981	16,29	5-6	12,50	1 - Micro
B	68982	26,35	19	17,00	1 - Mini
C	68983	35,90	65	18,00	1 - Chef
D	68988	45,75	40	16,00	1 - Profesional



Cuando el orificio de entrada de oxígeno este descubierto, la llama será más intensa

When the oxygen inlet is uncovered, the flame will be more intense

Pistola Gas repostería

Torche à caraméliser
Gasbrenner
Pastry Gas Torch
Queimadora a Gás para pastelaria

	Ref	€	Cap. (ml)	h (cm)	U.Venta
	68969	18,99	21	13,00	1



Válvula recarga gas
Refill valve

▶ SOPLETE · QUEMADOR



Adaptador para poder utilizar distintos tipos de botellas de gas
 Adaptateur pour pouvoir utiliser différents types de bouteilles de gaz
 Adapter für verschiedene Gasflaschen
 Adapter enables it to be used with different types of gas bottles
 Adaptador para poder utilizar diferentes tipos de garrafas de gás



Cabezal soplete gas + Adaptador PROFESIONAL

Torche à caraméliser + Adaptateur
 Gasbrenner-Aufsatz + Adapter
 Blow torch head + Adapter
 Queimadora a gás + Adaptador

Ref	€	W	Consumo (g/h)	U.Venta
68974	21,68	1,65	120	1

Botella de gas NO incluida · Gas of bottle NOT included

Cabezal soplete gas PROFESIONAL

Torche à caraméliser
 Gasbrenner-Aufsatz
 Blow torch head
 Queimadora a gás

Ref	€	W	Consumo (g/h)	U.Venta
68984	14,01	1,65	120	1

Botella de gas NO incluida · Gas of bottle NOT included



Soplete gas PROFESIONAL

Torche à caraméliser
 Brüllerbrenner
 Blow torch
 Queimador a gás

Ref	€	Kw	Temp.	g/h	U.Venta
68968	26,66	1,7	1300°C	123	1

Válido para gas butano, NO gas natural · Valid for butane gas, NOT natural gas



Recargable con cartuchos universales de gas tipo C200 (190g) (No incluido).
Encendido Piezoeléctrico.
Flujo ajustable.
Función de precalentamiento integrada que garantiza una configuración de llama óptima.
Sistema 360°, permite el uso en cualquier posición y siempre con llama constante.
Sistema de bloqueo de seguridad.
Mango ergonómico de polipropileno resistente a altas temperaturas y golpes.

Refillable with universal type C200 (190 g.) gas cartridges (no. included).
 Piezoelectric ignition
 Adjustable flow
 Built in pre-heating function that guarantees optimal flame configuration
 The 360° System lets you use the torch in any position and always with a constant flame.
 Safety locking system
 Ergonomic polypropylene handle that can withstand high temperatures and impacts.



Queimador eléctrico redondo
 Fer à caraméliser électrique rond
 Karamellisierer rund
 Round electric caramelizer
 Queimador eléctrico redondo

Ref	€	U.Venta
68651	98,57	1
68652	113,92	1



Incluye soporte
 Includes support



Queimador crema fundición
 Fer à caraméliser
 Karamellisierer
 Caramelizer
 Queimador leite-creme fundição

Ref	€	Ø (cm)	U.Venta
68650	16,50	10	1

Ref	Tensión/Voltage	Potencia/Power	Dimensiones/Sizes	Peso/Weight
68651	220-230 V / 50-60 Hz	650 W	Ø10 cm	1,132 Kg
68652	220-230 V / 50-60 Hz	1.000 W	Ø12 cm	1,268 Kg

DOSIFICADORES

Salado
Dâtéed



Dulce
Sweet



Diseño premiado en certámenes internacionales
International award-winning flow
Good Design 2003 International Industrial
Graphic Design Competition The Chicago Athenaeum

Ideal para rellenar, verter y decorar
Ideal for filling, pouring and decorating



Dosificador
Entonnoir à décor
Dosierer
Portionner
Dosificador

Ref.	€	L.	U.Venta
67000	75.43	2,00	1



Cono de acero inoxidable 18/10, excelente resistencia a la corrosión, los ácidos alimentarios y sales. Capacidad 2 L.
Soporte mango con sistema de gatillo para un caudal ajustable.
Base con mucha estabilidad. Fácil desmontaje para una cómoda y sencilla limpieza.
Contiene una válvula y 3 boquillas para que las cremas y salsas fluyan en menor o mayor cantidad tanto calientes como frías.

Cône en acier inoxydable 18/10, excellente résistance à la corrosion ainsi qu'aux acides et sels alimentaires. Capacité 2 L.
Support manche avec système de gâchette pour un débit ajustable.
Base d'une très grande stabilité et facile à démonter pour un nettoyage simple et pratique.
Contient une valve et 3 embouts pour que les crèmes et les sauces, aussi bien chaudes que froides, coulent en quantité plus ou moins importante.

Konus aus Edelstahl 18/10, besonders widerstandsfähig gegen Korrosion, Lebensmittel Säuren und Salze. Kapazität 2 L.
Griff mit Abzug für einen regulierbaren Durchflussmesser.
Stabile und einfach auseinandernehmbare Befestigung für eine bequeme und einfache Reinigung.
Binhaltet ein Ventil und 3 Tüllen, damit Cremes und Saucen, sowohl kalte als auch warme, in kleinerer oder größerer Menge fließen.

18/10 stainless steel cone, excellent resistance to corrosion, food acids and salts. 2 litre capacity.
Support handle with trigger system for an adjustable flow.
Base offers great stability and easy disassembly for convenient and easy cleaning.
Contains a valve and 3 nozzles so that hot and cold creams and sauces flow in greater or lesser quantities.

Cone em aço inoxidável 18/10, com excelente resistência à corrosão, aos ácidos alimentares e aos sais. Capacidade para 2 litros.
Suporte com mango com sistema de gatilho, para um caudal ajustável.
Base com grande estabilidade e fácil de desmontar, para uma limpeza fácil e cómoda.
Contém uma válvula e 3 boquilhas para posar com precisão a quantidade de cremes e molhos, quentes ou frios.

Cono Inox 18/10

Cône
Trichter
Cone
Cone Inóx 18/10

Ref.	€	L.	U.Venta
R67000	33.51	2,00	1



Soporte mango

Support
Stütze
Support
Suporte cabo

Ref.	€	U.Venta
R67001	30.19	1



Base negra

Base noire
Ständer, schwarz
Black base
Base negra

Ref.	€	U.Venta
R67002	11.83	1



Boquillas

Douille
Düse
Nozzle
Boquilhas

	Ref.	€	Ø (mm)	U.Venta
A	R67003	1.35	1	1
B	R67004	1.56	4	1
C	R67005	1.56	6	1
D	R67006	1.56	8	1





Ideal para rellenar, verter y decorar
Perfect for filling, pouring and decorating

New



Incluye soporte y un
platillo anti-goteo
Includes support
and a drip dish

Inox
18/10



Dosificador

Entonnoir à décor
Dosierer
Portionner
Dosificador

Ref	€	Ø (cm)	h (cm)	L	U.Venta
67150	49.70	19	27	2,0	1
8671508	16.08	4/6/8			1

Set 3 boquillas
Set 3 nozzles

Ideal para rellenar o decorar platos con salsas y cremas calientes y frías.
Sistema de palanca para un caudal ajustable; práctico y preciso.
Sistema antigoteo y antisalpicaduras.
Mango con diseño ergonómico que permite el manejo con una sola mano.
Fácil desmontaje para una sencilla limpieza. Apto para el lavavajillas.
Ref.: 67150: Contiene 3 boquillas de distintos diámetros (4, 6 y 8 mm) para que las cremas y salsas fluyan de la forma deseada, en menor o mayor cantidad.

Idéal pour remplir ou décorer des assiettes avec des sauces chaudes et froides.
Système de piston pour un débit ajustable ; pratique et précis.
Système anti-goutte et anti-éclaboussures.
Manche ergonomique qui permet de le manipuler d'une seule main.
Facile à démonter pour un nettoyage aisé, et apte pour le lave-vaisselle.
Ref. 67150: Contient 3 embouts de différents diamètres (4, 6 et 8 mm) pour que les crèmes et les sauces coulent de la façon souhaitée, en plus ou moins grande quantité.

Er eignet sich ideal zum Anrichten oder Servieren von Saucen und Cremes, gleich ob kalt oder warm.
Das Hebelsystem ermöglicht einen dosieren, bequemen und geraden Ausschank.
Antitropf- und Antispritzsystem.
Ergonomischer Griff für Einhandbedienung.
Zum Reinigen einfach auseinandernehmbar und spülmaschinengeeignet.
3 Aufsätze im Durchmesser von 4, 6 und 8 Millimeter für einen Ausschank von Saucen und Cremes genau nach Bedarf.

Perfect for filling or decorating dishes with hot or cold sauces and cream.
The lever system for controlling the flow is practical and precise.
Anti-drip and anti-splash system.
The ergonomic handle means it can be used with just one hand.
It's easy to disassemble for easy cleaning and it's dishwasher safe.
Ref. 67150: Includes 3 nozzles with different diameters (4, 6 and 8 mm) so cream or sauce can flow just how you want, at a higher or lower quantity.

Ideal para decorar platos e dispensar molhos e cremas, quentes ou frios.
Caudal ajustável mediante sistema de alavanca, práctico e preciso.
Sistema anti-gotejamento e anti-salpicaduras.
Mango com desenho ergonómico, que permite a manipulação com uma só mão.
Fácil de desmontar para a sua limpeza.
Apto para máquinas de lavar louça.
Ref. 67150: Inclui 3 boquillas de diferentes diâmetros (4, 6 e 8 mm), que assegurarão um fluxo adequado dos cremes e molhos, em menor ou maior quantidade.



Salado - Salty



Dulce - Sweet

Marcas de medición
en el contenedor (ml - Cup)
Measuring marks
on the container (ml - Cup)



Dispensador de repostería
Distributeur de pâtisseries
Teigspender
Batter dispenser
Distribuidor de pastelería

Ref	€	L	cm	h (cm)	U.Venta
67026	10.17	1,00	16x11	18	1

SIFONES

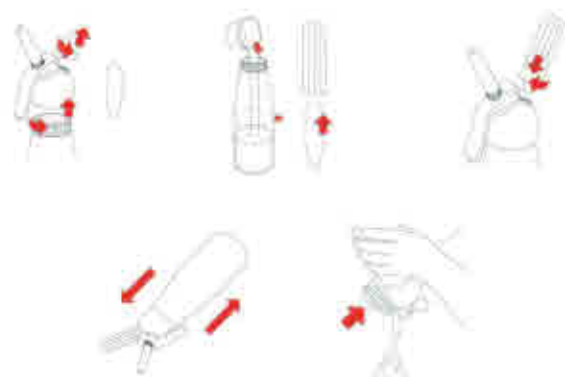

Realice en segundos purés, mousses, cremas montadas, espumas, salsas y deliciosos postres, un toque de elegancia en la cocina.
Ofrece 4 veces más volumen que el volumen líquido.
NQ debe ser empleado con líquidos calientes. **NUNCA** ponga los sifones al baño maría, puede producirse una explosión con graves consecuencias.

Réalisez en quelques secondes des purées, des mousses, des crèmes montées, des sauces et de délicieux desserts: une touche d'élegance dans la cuisine.
Contiène 4 fois plus de volume que le volume liquide.
NE JAMAIS être utilisé avec des liquides chauds. **NE JAMAIS** mettre les siphons au bain marie, car une explosion pourrait avoir lieu et provoquer de graves conséquences.

Pürees, Mousses, Schlagsahne, Schäume, Saucen und köstliche Desserts im Nu zubereiten, ein Hauch von Eleganz in der Küche.
Vervielfacht das Ausgangsvolumen der Flüssigkeit.
NICHT für Verwendung mit heißen Flüssigkeiten geeignet. Gerät **NIE** in ein Wasserbad legen. Dies kann zu einer folgenschweren Explosion führen.

Make purées, mousses, whipped creams, foams, sauces and delicious desserts in seconds. A touch of elegance in the kitchen.
Whips contain up to 4 times the liquid volume.
Should **NOT** be used with hot liquids. **NEVER** put siphons in a water bath, as this may cause an explosion with serious consequences.

Prepara em segundos purés, mousses, cremas batidas, espumas, molhos e deliciosas sobremesas, dando um toque de elegância à sua cozinha.
Proporciona 4 vezes mais volume do que o volume líquido.
NÃO utilizar com líquidos quentes. **NUNCA** coloque os sifões em banho maria, para evitar o risco de explosão com consequências graves.



APTO SOLAMENTE PARA MEZCLAS FRIAS Y TEMPLADAS (<40°C)
À UTILISER UNIQUEMENT POUR LES MELANGES FROIDS ET TREMPÉS (<40°C)
ONLY SUITABLE FOR COLD AND TEMPERED MIXTURES (<40°C)



Cargas sifón N₂O

Cartouches N₂O pour siphon
N₂O-Kiesel für Sahnereisiter
N₂O cream charger
Botijas de sifão N₂O



EXCLUSIVAMENTE PARA USO ALIMENTICIO
EXCLUSIVELY FOR FOOD USE

Ref.	€	Botellas	g	U.Venta
68402	7,16	10	8	1
68403	16,70	24	8	1

Cabezal Head: **Aluminio** / Aluminium
Botella Bottle: **Inox**

Sifón crema

Siphon à crème
Sahnereisiter
Cream whipper
Sifão creme

Ref.	€	Ø (cm)	L	U.Venta
68404	103,23	7,8x25	0,50	1
68405	118,48	9,3x32,5	1,00	1

Temperatura de uso Use temperature
min = +5°C / max = +40°C



Cabezal Head: **Plástico PBT** / PBT plastic
Botella Bottle: **Aluminio** / Aluminium

Sifón crema

Siphon à crème
Sahnereisiter
Cream whipper
Sifão creme

Ref.	€	Ø (cm)	L	U.Venta
68502	35,59	9x27	0,25	1
68500	42,23	9x31	0,50	1
68501	47,00	11x36	1,00	1

Temperatura de uso Use temperature
min = +5°C / max = +40°C



Cabezal Head: **Aluminio** / Aluminium
Botella Bottle: **Aluminio** / Aluminium

Sifón GREEN

Siphon à crème
Sahnereisiter
Cream whipper
Sifão creme

Ref.	€	Ø (cm)	L	U.Venta
68504	44,51	7,8x27,3	0,50	1
68505	48,97	9,3x32,5	1,00	1

Temperatura de uso Use temperature
min = +5°C / max = +40°C



Cabezal Head: **Aluminio** / Aluminium
Botella Bottle: **Aluminio** / Aluminium

Sifón BLACK

Siphon à crème
Sahnereisiter
Cream whipper
Sifão creme

Ref.	€	Ø (cm)	L	U.Venta
68604	44,51	7,8x27,3	0,50	1
68605	48,97	9,3x32,5	1,00	1

Temperatura de uso Use temperature
min = +5°C / max = +40°C



MANGAS REPOSTERÍA



Mangas pasteleras para decorar y personalizar tus postres preferidos. Mangas de alta calidad, soportan altas temperaturas, resistentes y reutilizables. Aptas para el lavavajillas.

Poche à douille pour décorer et personnaliser vos desserts préférés. Poche de grande qualité, supporte des températures élevées, résistante et réutilisable. Compatible avec le lave-vaisselle.

Spritzbeutel zur Dekoration und individuellen Gestaltung deiner Lieblingsnachtsische. Spritzbeutel aus Qualität, beständig auch bei hohen Temperaturen, robust und wiederverwendbar. Spülmaschinengeeignet.

Pastry bag to decorate and customise your favourite desserts. Bag of high quality withstands high temperatures and is durable and reusable. Dishwasher safe.

Manga de pastelaria para decorar e personalizar as tuas sobremesas favoritas. Manga de alta qualidade, que suporta altas temperaturas, resistente e reutilizável. Apta para a máquina de lavar louça.



SI | **PP**
Silicone | Polipropileno

Manga repostería + 5 boquillas
Poche à décorer + 5 Douilles
Spritzbeutel + 5 Tig. Tüllensortiment
Pastry bag + 5 pcs. Nozzles
Manga de pastelaria + 5 Boquillas

Ref	€	ml	h (cm)	U.Venta
68971	6,54	800	30	1



A | **B**
Inox 18/10 | EVA Plástico | PP Polipropileno

Manga repostería + 4 boquillas
Poche à décorer + 4 Douilles
Spritzbeutel + 4 Tig. Tüllensortiment
Pastry bag + 4 pcs. Nozzles
Manga de pastelaria + 4 Boquillas

Ref	€	cm	Ø (cm)	U.Venta
A 68972	6,33	20	20x30	1
B 68973	10,69	30	25x45	1

Boca - Mouth: Ø2,5 cms.
Se adaptan a cualquier tipo de boquilla
Adapts to any kind of nozzle

PA
Nylon

Manga repostería Nylon
Poches à décorer en nylon
Nylon Spritzbeutel
Nylon pastry bag
Manga de pastelaria de nylon

Ref	€	h (cm)	L	U.Venta
68930	4,46	30	0,57	6
68935	5,19	35	1,10	6
68940	5,71	40	1,45	6
68945	6,74	45	2,30	6
68950	7,47	50	2,50	6
68955	8,20	55	3,40	6
68960	9,23	60	3,50	6
68965	9,75	65	6,50	6
68970	11,72	70	7,50	6

Galga 280 = 70 micras (µm)
Se adaptan a cualquier tipo de boquilla
Adapts to any kind of nozzle

LDPE
Low Density Polyethylene

Mangas desechables
Poche à décorer jetable
Einweg Spritzbeutel
Non-returnable pastry bags
Mangas descartáveis

Ref	€	Cantidad	AxB (cm)	U.Venta
68937	12,66	100	35x21	1
68939	18,26	100	40x22	1
68954	27,29	100	55x30	1
68964	32,06	100	65x32	1

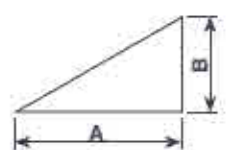

No emplear con alimentos a temperaturas superiores a 60°C
Ne pas utiliser avec des aliments à une température supérieure à 60°C.
Not for use with food at temperatures above 60°C.

BOQUILLAS



Inox
18/10

Fabricadas en acero inoxidable 18/10.
Excelente resistencia a la corrosión y a los ácidos alimentarios y sales.
Adaptables a las mangas de repostería.
Distintas formas para decorar postres.

Fabriquées en acier inoxydable 18/10.
Excellente résistance à la corrosion et aux acides et sels alimentaires.
Adaptables sur les poches à douilles de pâtisserie.
Différentes formes pour décorer les desserts.

Aus nicht rostendem 18/10-Stahl hergestellt.
Sehr korrosionsbeständig und widerstandsfähig gegen Säure aus Lebensmitteln und Salzen.
Passen auf Spritzbeutel.
Diverse Formen zur Verzierung von Desserts.

Made of 18/10 stainless steel.
Excellent resistance to corrosion and to food acids and salts.
Can be adapted to piping bags.
Different shapes for decorating desserts.

Fabricadas em aço inoxidável 18/10.
Excelente resistência à corrosão e aos ácidos e sais alimentares.
Adaptáveis às mangas de pastelaria.
Diferentes formas para decorar sobremesas.

Set de 6 boquillas redonda

Ensemble 6 douilles unies
Lochtüllensatz 6-tlg. rund
6 plain tube set
Conjunto de 6 boquillas redondas

Ref	€	Ø (mm)	U.Venta
68904	22,00	4	1
68906	22,00	6	1
68908	22,00	8	1
68910	22,00	10	1
68912	22,00	12	1
68915	22,00	15	1



Set de 6 boquillas estreita

Ensemble 6 douilles cannelées
Lochtüllensatz 6-tlg. Stern
6 star tube set
Conjunto de 6 boquillas estreita

Ref	€	Ø (mm)	U.Venta
68924	22,00	4	1
68926	22,00	6	1
68928	22,00	8	1
68900	22,00	10	1
68932	22,00	12	1
68934	22,00	15	1



Set de 6 boquillas rosa

Ensemble 6 douilles cannelées fermes
Tüllensatz 6-tlg. Stern, geschlossen
6 close star tube set
Conjunto de 6 boquillas rosa

Ref	€	Ø (mm)	U.Venta
68944	22,00	4	1
68946	22,00	6	1
68948	22,00	8	1
68980	22,00	10	1
68942	22,00	12	1
68985	22,00	15	1



Set de 6 boquillas cinta estrella

Ens. 6 douilles à bouche
Tüllensatz 6-tlg., Stern breit
6 wide log tube
Conjunto de 6 boquillas cinta estrella

Ref	€	Ø (mm)	U.Venta
68990	22,00	10	1
68918	22,00	18	1
68995	22,00	25	1



Set de 6 boquillas flor

Ensemble 6 douille fleur
Tüllensatz 6-tlg., Blume
6 flower tube
Conjunto de 6 boquillas flor

Ref	€	Ø (mm)	U.Venta
68914	22,00	4	1
68938	22,00	8	1
68952	22,00	12	1



Set de 6 boquillas lágrima

Ensemble 6 douille déchirer
Tüllensatz 6-tlg., Träne
6 tear tube
Conjunto de 6 boquillas rasgar

Ref	€	Ø (mm)	U.Venta
68901	22,00	20	1
68916	22,00	25	1



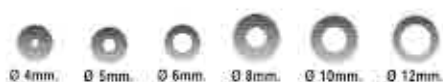

Set de 6 boquillas redonda

Ensemble 6 douilles unies
 Lochtüllensatz 6-tlg. rund
 6 plain tube set
 Conjunto de 6 boquillas redonda

Ref	€	Forma (mm)
68996	14,53	Redonda 4/5/6/8/10/12



Set de 6 boquillas estrella

Ensemble 6 douilles cannelées
 Tüllensatz 6-tlg. Stern
 6 star tube set
 Conjunto de 6 boquillas estrella

Ref	€	Forma (mm)
68997	14,53	Estrella 4/5/6/8/10/12



Set de 6 boquillas rosa

Ensemble 6 douilles cannelées fermes
 Tüllensatz 6-tlg. Stern, geschlossen
 6 closed star tube set
 Conjunto de 6 boquillas rosa

Ref	€	Forma (mm)
68993	14,53	Rosa 4/6/8/10/12/15

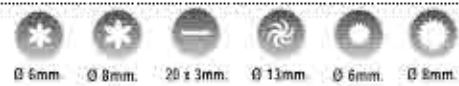

Set de 6 boq. variadas

Ens. 6 douilles variées
 Tüllensatz 6-tlg.
 6 assorted tube set
 Conjunto de 6 boquillas variadas

Ref	€	Forma (mm)
68998	14,53	Rosa 6/8
		Cinta 20x3
		Helice 5
		Estrella 6/9/13



Set de 6 boquillas variadas

Ensemble 6 douilles variées
 Tüllensatz 6-tlg. sortiert
 6 assorted tube set
 Conjunto de 6 boquillas variadas

Ref	€	Forma (mm)
68999	14,53	Rosa 6/8
		Helice 5
		Estrella 6/9/13

Set de 2 boquillas relleno

Ensemble 2 douilles petit chou
 Einfülltüllensatz 2-tlg.
 2 Bismark tube set
 Conjunto de 2 boquillas relleno

Ref	€	Forma (mm)
68992	9,55	Relleno 4/8



Crea originales flores de glas o buttercream de forma rápida y sencilla

Créez des fleurs originales avec du glaçages ou de la crème au beurré de façon rapide et simple
 Create original icing or buttercream flowers quickly and easily

Juego 6 boquillas Rusas

Ensemble 6 douilles Russes
 6-Tlg Russian Tüllensatz
 Set 6 Russian decorating nozzles
 Conjunto 6 boquillas Ruso

Ref	€	Ø (cm)	h (cm)	Unidades	U.Venta
A 68892	7,37	3,5	4,5	6	6
B 68893	12,66	3,0	6,2	6	1

A



B



Inox

Juego de boquillas decoración

Douilles assorties décoration
 Dekorations-Tüllensatz
 Decorating nozzles
 Jogo de boquillas decoração

Ref	€	Piezas	U.Venta
68991	14,21	26	1



ASA

Acrylic



Set 24 pcs. boquillas acrílicas

24 pcs. douilles assorties, acrylique
 24 tlg. Tüllensortiment, Acryl
 24 pcs. acrylic nozzles set
 Conjunto de 24 boquillas acrílicas

Ref	€	Piezas	U.Venta
68994	13,07	24	1



▶ AERÓGRAFO CON COMPRESOR

New

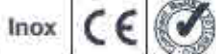

Ideal para la decoración de tartas, galletas, cupcakes, bombones, etc.
Permite obtener detalles únicos en creaciones artísticas de repostería.
El kit contiene: compresor, aerógrafo y tubo conector.
Compresor con regulador de presión de aire.
0 - 2 bares y con un caudal de 0 - 10 L/min.
Aerógrafo por gravedad de doble acción con aguja de salida de 0,3 mm.
Depósito de pintura metálico con capacidad de 7 ml.
Incluye una caja acolchada para almacenar el aerógrafo.

Ideal pour la décoration de gâteaux, biscuits, cupcakes, chocolats, etc.
Permet d'obtenir des détails uniques sur des créations artistiques de pâtisserie.
Le kit contient : compresseur, aérographe et tuyau connecteur.
Compresseur avec régulateur de pression d'air.
0 - 2 bars et avec un débit de 0 - 10 L/min.
Aérographe par gravité à double action avec aiguille de sortie de 0,3 mm.
Réservoir de peinture métallique d'une capacité de 7 ml.
Inclut une boîte matelassée pour ranger l'aérographe.

Ideal zur Dekoration von Torten, Keksen, Muffins, Pralinen usw.
Erleert kunstvolle und einzigartige Details auf Feingebäck.
Lieferumfang: Kompressor, Airbrush Spritzpistole, Verbindungsschlauch.
Kompressor mit einem einstellbaren Arbeitsdruck von
0-2 Bar und einer Durchflussmenge von 0-10 l/min.
Airbrush Spritzpistole mit Doppelfunktion und einer Düsenstärke von 0,3 mm.
7 ml Farbbehälter aus Metall.
Mit gepolsterter Aufbewahrungsbox für die Spritzpistole.

Perfect for decorating cakes, biscuits, cupcakes, bombons, etc.
Lets you get unique details on artistic bakery creations.
The set contains: Compressor, airbrush and air hose.
Compressor with air pressure regulator
0 - 2 bars with a 0 - 10 L/min flow
Double action gravity feed airbrush with a 0.3-mm needle.
Metal paint cup with a 7 ml capacity.
Includes a padded box for storing the airbrush.

Permite obtener detalles únicos en creaciones artísticas de repostería

Lets you get unique details on artistic bakery creations

Ideal para decorar tartas, bolachas, cupcakes, bombons, etc.
Permite criar pormenores únicos em trabalhos artísticos de pastelaria.
O kit inclui: compressor, aerógrafo e tubo conector.
Compressor com regulador de pressão de ar
0 - 2 bares, com um caudal de 0 - 10 l/min.
Aerógrafo por gravidade, de dupla ação, com agulha de saída de 0,3 mm.
Depósito de pintura metálico com capacidade para 7 ml.
Inclui uma caixa acolchada para guardar o aerógrafo.



Aerógrafo con compresor

Aérographe avec compresseur
 Airbrush Spritzpistole mit Kompressor
 Airbrush with compressor
 Aerógrafo com compressor

Ref.	€	W	Presión	Caudal	U. Venta
69450	88.81	20	0 - 2 bar	0 - 10 L/min	1

Ref.	Tensión Voltage	Potencia Power	Presión Pressure	Caudal air Air flow	Capacidad Capacity	Long. tubo aire Air tube length	Aerógrafo Airbrush	Med. compresor Compressor size	Peso Weight
69450	220-240 V ; 50/60 Hz	20 W	0 - 2 bar	0 - 10 L/min	7 ml	1,80 m	14,2x2,5x9	11,5x13,5x6 cm	800 g

DECORACIÓN



Cazo desmontable de acero inoxidable 18/10 de gran calidad
High quality 18/10 stainless steel collapsible pan

Preparar fácilmente coberturas para sus postres. Puede añadirle especias (canela, jengibre en polvo, pimientas, vainilla) para un chocolate más intenso.

Easy to prepare toppings for your desserts. You can add spices (cinnamon, ginger powder, peppers, vanilla) for a more intense chocolate.

Inox 18/10

Baño María chocolate

Bain Marie de chocolat
Bain Marie topf für Schokolade
Chocolate Bain Marie
Banho-Maria Chocolate



Permite fundir chocolate y mantenerlo caliente
It allows you to melt chocolate and keep it hot

Ref	€	W	U.Venta
69317	35,59	50	1

Ref	Tensión/Voltage	Potencia/Power	Temperatura/Temp.	Capacidad/Capacity	Dimensiones/Sizes	Peso/Weight
69317	230-240 V / 50-60 Hz	50 W	40-50°C	1.0 L (max)	29x22x12 cm	0,875 Kg

PE PELO

Polyethylene Polyethylene

Botella biberón con boquilla triple

Bouteille biberon avec douille triple
Dosierflasche mit Dreifachdüse
Squeeze bottle with triple nozzle
Garrafa com boquilha triplo



Polyethylene (PE)

Polyethylene (PELD)

Polyethylene low density

Ref	€	Ø (cm)	ml	U.Venta
61974	3,22	7x20	472	6
61977	3,42	7x26	708	6



SI

Silicone

Biberón decoración

Biberon à decorer
Dekorierflasche
Decorating pen
Garrafa decoração



Ref	€	Ø (cm)	ml	U.Venta
64457	7,78	5,5x16	140	1



PP

Polypropylene

SI

Silicone

Biberón decoración

Biberon à decorer
Dekorierflasche
Decorating pen
Garrafa decoração



Ref	€	Ø (cm)	ml	U.Venta
64458	7,99	5x17,5	150	6

Inox 18/10

Juego pistola repostería

Pistolet pour pâtisserie
Pistole für Tüllensätze
Cookie press cum icing set
Jogo de pistola pastelaria



Ref	€	ml	U.Venta
68989	41,40	250	1

Inox 18/10

Pistola decoración repostería

Pistolet Décoration Pâtisserie
Pistole für Tüllensätze
Pastry Decoration Gun
Pistola Decoração Pastelaria



Ref	€	ml	U.Venta
61407	28,01	250	1

Acero cromado
Cocina
200

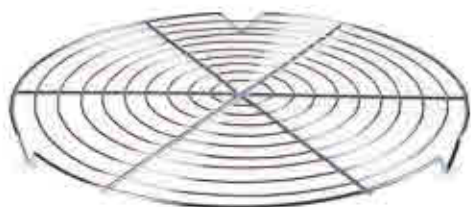

Rejilla para repostería

Grille pâtisserie
Kuchengitter rund
Pastry rack
Greilha para pasteleria

Ref	€	Ø (cm)	U.Venta
66926	5,40	32	6

Rejillas de alambre resistentes para dejar reposar los postres recién sacados del horno o cubrir de chocolate o azúcar glas. Fabricadas en acero cromado para una larga duración. Permite enfriar homogéneamente todas las partes del postre incluida la parte inferior. Protegen las superficies de la cocina de quemaduras. No se recomienda su uso en el lavavajillas.

Grilles de refroidissement en métal pour laisser reposer les desserts fraîchement sortis du four ou les napper de chocolat ou de sucre glace. Fabricées en acier chromé pour une grande durabilité. Permet de refroidir de façon homogène toutes les parties du dessert, y compris la partie inférieure. Protège les surfaces de la cuisine des brûlures. Lavage au lave-vaisselle déconseillé.

Robustes Kuchenrost zum Ablagen der ofenfrischen Backwaren oder zum Auftragen einer Schokoladenglasur oder von Puderzucker. Aus widerstandsfähigem, verchromtem Stahl! Gebäck kühlt mithilfe dieses Gitters gleichmäßig ab, auch auf der Unterseite. Schützt die Oberfläche der Küchenplatte vor Verbrennungen. Nicht im Geschirrspüler reinigen.

Resistant wire rack for cooling freshly baked desserts or covering them in chocolate or sugar glass. Made of chrome steel for a long life. Allows all parts of the dessert to cool evenly, including the bottom. Protects kitchen surfaces from burns. Dishwasher not recommended.

Greilhas de arame resistentes para deixar repousar as sobremesas que se acabam de retirar do forno ou para cobrir com chocolate ou açúcar glas. Fabricadas em aço cromado para uma longa duração. Permite amolecer de maneira homogênea todas as partes dos bolos, incluindo a parte de baixo. Protege de queimaduras as superfícies da cozinha. Não se recomenda máquina de lavar louça.

Acero cromado
Cocina
200



Rejilla rectangular para repostería

Grille rectangulaire pour pâtisserie
Kuchengitter rechteckig
Rectangular pastry rack
Greilha rectangular para pasteleria

Ref	€	cm	U.Venta
66927	7,26	43x30	6



Inox
18/10

Portatartas

Gueridon pâtisier
Kuchenplatte
Cake stand
Porta-tartes



Ref	€	Ø (cm)	U.Venta
67030	149,19	30	1

Portatartas

Gueridon pâtisserie
Kuchenplatte
Cake stand
Porta-tartes



Ref	€	cm	U.Venta
63586	27,49	33x9	4



Porción de tarta

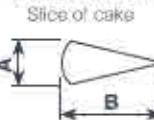

ABS
Plástico

Marcador de tartas

Marqueur à gateaux
Tortenteller
Cake marker
Marcador de bolos



Ref	€	Ø (cm)	Porciones	AxB (cm)	U.Venta
68511	7,57	27	10 / 12	8,5x13,5 / 7,5x13,5	1
68513	7,57	27	14 / 16	6x13,5 / 5,5x13,5	1

Inox
18/10

Pinza repostería

Pince à gateau
Gebäck-Tortenzange
Cake tong
Pinça pastelaria



Ref	€	L (cm)	U.Venta
62317	10,06	20	1

Inox
18/10

Pinza repostería con anillas

Pince à gateau avec anneaux
Gebäckzange
Cake tong with rings
Pinça pastelaria com anilhas



Ref	€	L (cm)	U.Venta
68008	5,08	16	6

▶ RACIONADORES HELADO



Inox
18/10



Utensilio de repostería perfecto para formar bolas de helado sin esfuerzo. Mecanismo de estilo guillotina para extraer y servir fácilmente bolas de helado.

Gran resistencia y durabilidad.

Fácil de usar y limpiar. Apto para lavavajillas.

Utensilio de pâtisserie parfait pour faire des boules de glace sans efforts. Mécanisme de style guillotine pour extraire et servir facilement les boules de glace. Grande résistance et durabilité. Facile à utiliser et à nettoyer. Apte pour le lave-vaisselle.

Form mühelos perfekte Eiskugeln. Schneidmechanismus zum einfachen Lösen und Anrichten von Eiskugeln. Sehr widerstandsfähigkeit und haltbar. Einfach zu benutzen und reinigen. Spülmaschinenfest.

A perfect confectionery utensil for making balls of ice cream effortlessly. Guillotine style mechanism for easily scooping and serving balls of ice cream. Very strong and durable. Easy to use and clean. Dishwasher safe.

Utensílio de pastelaria, ideal para formar bolas de gelado sem esforço. Mecanismo tipo guilhotina para extrair e servir facilmente bolas de gelado. Grande resistência e durabilidade. Fácil de usar e de limpar. Apto para máquinas de lavar louça.

Copa baja

Coupe à glace basse

Eiskelch

Ice cream cup

Taça de gelado



Ref.	€	Bolas/L	cm	U.Venta
67002	4,15	5,5	Ø9x12	12

Racionador Profesional

Cuillère à glace professionnel

Eisportionierer, Profi

Professional ice cream scoop

Racionador Profesional



Ref.	€	Bolas/L	Ø (mm)	U.Venta
67038	28,84	50	39	10
67043	28,84	40	44	10
67045	29,57	36	46	10
67047	29,57	30	48	10
67049	29,57	24	50	10
67052	30,61	20	53	10
67055	30,61	16	56	10
67058	30,61	13	59	10
67062	30,61	12	63	10
67065	30,61	10	66	10
67069	30,71	8	70	10
67074	30,71	7	75	10
67084	30,71	5	85	10

Racionador Helado

Cuillère à glace

Eisportionierer

Ice cream scoop

Racionador de gelado



Ref.	€	Bolas/L	Ø (mm)	U.Venta
67039	15,25	50	39	10
67044	15,25	40	44	10
67046	15,25	36	46	10
67048	15,25	30	48	10
67050	15,25	24	50	10
67053	15,56	20	53	10
67056	16,19	16	56	10
67059	16,19	13	59	10
67063	16,19	12	63	10
67066	16,50	10	66	10
67070	16,50	8	70	10

Inox
18/10



Racionador Profesional Oval

Cuillère à glace luxe ovale
Eisportionierer, Profi
Ice cream scoop luxe oval
Racionador oval Profesional

Ref	€	Bolas/L	Ø (mm)	U.Venta
67153	30,50	40	53x41	10
67158	30,50	30	58x48	10
67163	30,50	20	63x48	10

AL

Aluminium

Racionador helado Aluminio

Cuillère à glace Aluminium
Eisportionierer, Aluminium
Aluminium ice cream scoop
Racionador de gelado Aluminio



Ref	€	Bolas/L	Ø (mm)	ml	L (cm)	U.Venta
67090	8,40	50	50	12	18	1

New



Racionador Helado WHITE

Cuillère à glace
Eisportionierer
Ice cream scoop
Racionador de gelado

Ref	€	Bolas/L	Ø (mm)	U.Venta
67040	8,09	24	50	12

PA

Nylon

Fibra
de vidrio
Fiberglass

Inox



Utensile de repostería perfecto para formar bolas de helado sin esfuerzo. Diseño original, ergonómico y muy ligero. Fabricado en Nylon y fibra de vidrio. Libre de BPA. Mecanismo de estilo guillotina para extraer y servir fácilmente bolas de helado. Cuchara de 5 cm de diámetro, 24 bolas/L de capacidad. Gran resistencia y durabilidad. Fácil de usar y limpiar. Apto para lavavajillas.

Utensile de pâtisserie parfait pour faire des boules de glace sans efforts. Conception originale, ergonomique et très légère.

Fabriquée en nylon et fibre de verre. Sans BPA. Mécanisme de style guillotine pour extraire et servir facilement les boules de glace. Cuillère de 5 cm de diamètre, capacité de 24 boules/L. Grande résistance et durabilité. Facile à utiliser et à nettoyer. Apte pour le lave-vaisselle.

A perfect confectionery utensil for making balls of ice cream effortlessly. The design is original, ergonomic and very light weight. Made of Nylon and fiberglass BPA free. Guillotine style mechanism for easily scooping and serving balls of ice cream. 5 cm diameter spoon. 24 balls/L capacity. Very strong and durable. Easy to use and clean. Dishwasher safe.

New



Cucharas para servir helado. Fabricadas en acero inoxidable 18/10 de máxima calidad.

Mango ergonómico en plástico SAN, diseño antideslizante. Disponible en diferentes colores; azul, naranja, rojo, verde y transparente.

Cuillères pour servir la glace. Fabricées en acier inoxydable 18/10 de grande qualité. Manche ergonomique en plastique SAN, conception antidérapante. Disponible en différentes couleurs: bleu, orange, rouge, vert et transparent.

Servierlöffel für Eis. Aus nicht rostendem Edelstahl 18/10. Ergonomischer Griff aus SAN-Kunststoff, rutschfeste Form. Erhältlich in Blau, Orange, Rot, Grün und Transparent.

Spoons for serving ice cream. Made of 18/10 top quality stainless steel. Ergonomic SAN plastic handle, non-slip design. Available in different colours: Blue, orange, red, green and transparent.

Cuñeres para servir gelado. Fabricadas em aço inoxidável 18/10, de máx. qualidade. Mango ergonómico antiderrapante de plástico SAN. Disponível em diferentes cores: azul, laranja, vermelho, verde e transparente.

SAN

Plastic



Racionador de helado PRO

Cuillère à glace
Eisportionierer
Ice cream scoop
Racionador de gelado

	Ref	€	L (cm)	Color	U.Venta
A	67091	7,89	26,5	Azul / Blue	1
B	67092	7,89	26,5	Naranja / Orange	1
C	67093	7,89	26,5	Rojo / Red	1
D	67094	7,89	26,5	Verde / Green	1
E	67095	7,89	26,5	Transparente / Transparent	1



Moldes - Aros
Moulds - Cake Rings

#CocinaConLacor

MOLDES BLACK



Amplia gama de moldes de silicona para procesos de horneado y congelación.
Antiadherentes, flexibles, duraderos, higiénicos y fáciles de limpiar.
Soportan fuertes cambios de temperatura.
No transmiten sabores ni olores.
Permiten desmoldar fácil y perfectamente los alimentos.

Large gamme de moules en silicone pour enfournier et congeler.
 Antiadhésifs, flexibles, durables, hygiéniques et faciles à nettoyer.
 Supportent de fortes variations de température.
 Ne transmettent ni goûts ni odeurs.
 Permettent de démouler facilement et parfaitement les aliments.

Größes Angebot an Back- und Geleiformen aus Silikon.
 Mit Antihaftwirkung, flexibel, haltbar, hygienisch und leicht zu reinigen.
 Widerstandsfähig gegen abrupte Temperaturwechsel.
 Übertragen keinen Geschmack/Geruch.
 Einfaches und perfektes Ausformen möglich.

Wide range of silicone moulds for baking and freezing processes.
 Non-stick, flexible, long-lasting, hygienic and easy to clean.
 They can withstand drastic temperature changes.
 They do not transmit flavours or odours.
 Food can be de-moulded quickly and perfectly with them.

Ampla gama de moldes de silicona para levar ao forno e para congelar.
 Antiaderentes, flexíveis, duráveis, higiénicos e fáceis de limpar.
 Suportam grandes mudanças de temperatura.
 Não transmitem sabores nem cheiros.
 Permitem desmoldar fácil e perfeitamente os alimentos.

Antiadherentes, flexibles, duraderos, higiénicos y fáciles de limpiar

Non-stick, flexible, long-lasting, hygienic and easy to clean



Brioche 24 cavidades

Brioche 24 cavités
 Briocheform für 24 Madaleine
 Brochette 24 moulds
 Brochette 24 cavidades

Ref	€	Ø (mm)	h (mm)	ml
66760	86,22	79	35	84



Semiesférica 28 cavidades

Hemispher 28 cavités
 Halbkugelform für 28 Madaleine
 Half-spheres 28 moulds
 Semi-esférica 28 cavidades

Ref	€	Ø (mm)	h (mm)	ml
66761	86,22	70	35	90



Semiesférica 60 cavidades

Hemispher 60 cavités
 Halbkugelform für 60 Madaleine
 Half-spheres 60 moulds
 Semi-esférica 60 cavidades

Ref	€	Ø (mm)	h (mm)	ml
66747	84,56	42	20	10



Mini semiesférica 96 cavidades

Mini Hemispher 96 cavités
 Mini Halbkugelform für 96 Madaleine
 Mini Half-spheres 96 moulds
 Mini semi-esférica 96 cavidades

Ref	€	Ø (mm)	h (mm)	ml
66752	86,22	35	11,70	11



New



Florentina 15 cavidades

Florentina 15 cavités
Florentinerform für 15 Madaleine
Florentina 15 moulds
Florentina 15 cavidades

Ref	€	Ø (mm)	h (mm)	ml
66748	84,56	100	20	100



Florentina 40 cavidades

Florentina 40 cavités
Florentinerform für 40 Madaleine
Florentina 40 moulds
Florentina 40 cavidades

Ref	€	Ø (mm)	h (mm)	ml
66764	86,22	60	11	25



Madalena 44 cavidades

Madaleine 44 cavités
Madaleiniform für 44 Madaleine
Madaleine 44 moule
Madalena 44 cavidades

Ref	€	mm	h (mm)	ml
66763	86,22	77x44,5	18	32



Mini muffin 70 cavidades

Mini muffin 70 cavités
Mini Muffinform klein für 70 Madaleine
Mini muffin 70 moulds
Mini muffin 70 cavidades

Ref	€	Ø (mm)	h (mm)	ml
66765	86,22	45	30	40



Muffin 24 cavidades

Muffin 24 cavités
Muffinform für 24 Madaleine
Muffin 24 moulds
Muffin 24 cavidades

Ref	€	Ø (mm)	h (mm)	ml
66766	86,22	69	39	122



Tartaleta 60 cavidades

Tartalette 60 cavités
Torteileinform für 60 Madaleine
Tartel 60 moulds
Tarte 60 cavidades

Ref	€	Ø (mm)	h (mm)	ml
66767	86,22	44	10	10



Piramide 35 cavidades

Pyramide 35 cavités
Pyramidenform für 35 Madaleine
Pyramid 35 moule
Pirâmide 35 cavidades

Ref	€	mm	h (mm)	ml
66768	86,22	65x65	35	61



Mini cake 30 cavidades

Mini cake 30 cavités
Mini Kuchenform für 30 Madaleine
Mini cake 30 moulds
Mini cake 30 cavidades

Ref	€	mm	h (mm)	ml
66769	86,22	99x49	30	110

100%
Platinum
silicone

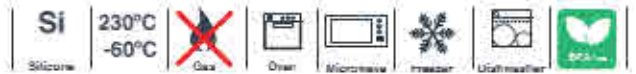

BANDEJA GASTRONORM
Uso de 3 moldes

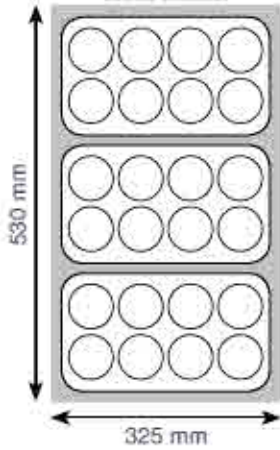

Dimensiones / Sizes

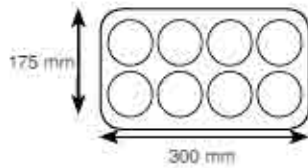

BANDEJA 60x40
Uso de 4 moldes

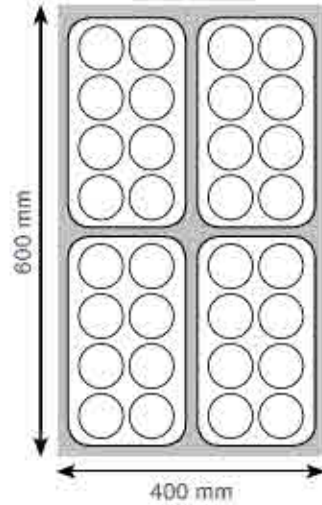

Cilindro 8 cavidades

Cylindre 8 cavités
Zylinderform für 8 Madeleine
Cylindre 8 moulds
Cilindro 8 cavidades

Ref	€	Ø (mm)	h (mm)	U.Venta
66807	13,38	60	35	1

Cilindro mediano 11 cavidades

Cylindre moyen 11 cavités
Zylinderform, mittelgross für 11 Madeleine
Medium cylindre 11 moulds
Cilindro médio 11 cavidades



Ref	€	Ø (mm)	h (mm)	U.Venta
66812	13,38	45	48	1

Cilindro grande 8 cavidades

Grand cylindre 8 cavités
Zylinderform, gross für 8 Madeleine
Large cylindre 8 moulds
Cilindro grande 8 cavidades



Ref	€	Ø (mm)	h (mm)	U.Venta
66813	13,38	55	60	1

Madalena 9 cavidades

Madeleine 9 cavités
Madeleineform 9 Madeleine
Madeleine 9 moulds
Madalena 9 cavidades



Ref	€	mm	h (mm)	U.Venta
66817	13,38	78x45	17	1

Madalena pequena 15 cavidades

Petite madeleine 15 cavités
Madeleineform, Klein, für 15 Madeleine
Small madeleine 15 moulds
Madalena pequena 15 cavidades



Ref	€	mm	h (mm)	U.Venta
66816	13,38	42x30	11,5	1

Briochelette 6 cavidades

Briochelette 6 cavités
Briocheform 6 Madeleine
Briochelette 6 moulds
Briochelette 6 cavidades



Ref	€	Ø (mm)	h (mm)	U.Venta
66819	13,38	103	20	1

Briochelette 6 cavidades

Briochelette 6 cavités
Briocheform 6 Madeleine
Briochelette 6 moulds
Briochelette 6 cavidades



Ref	€	Ø (mm)	h (mm)	U.Venta
66820	13,38	79	30	1

Semi esférica 24 cavidades

Hemispher 24 cavités
Halbkugelform 24 Madeleine
Half-spheres 24 moulds
Semi-esférica 24 cavidades



Ref	€	Ø (mm)	h (mm)	U.Venta
66800	13,38	30	17	1

Semiesférica 15 cavidades

Hemispher 15 cavités
 Halbkugelform 15 Madeleine
 Half-spheres 15 moulds
 Semi-esférica 15 cavidades



Ref.	€	Ø (mm)	h (mm)	U.Venta
66801	13,38	40	20	1

Semiesférica 6 cavidades

Hemispher 6 cavités
 Halbkugelform 6 Madeleine
 Half-spheres 6 moulds
 Semi-esférica 6 cavidades



Ref.	€	Ø (mm)	h (mm)	U.Venta
66802	13,38	70	35	1

Piramide 15 cavidades

Pyramide 15 cavités
 pyramideform 15 Madeleine
 Pyramid 15 moulds
 Pirâmide 15 cavidades



Ref.	€	mm	h (mm)	U.Venta
66821	13,38	36x36	22	1

Piramide 6 cavidades

Pyramide 6 cavités
 Pyramideform 6 Madeleine
 Pyramid 6 moulds
 Pirâmide 6 cavidades



Ref.	€	mm	h (mm)	U.Venta
66822	13,38	71x71	41	1

Ovalo 16 cavidades

Ovale 16 cavités
 Ovale Form 16 Madeleine
 Oval 16 moulds
 Oval 16 cavidades



Ref.	€	mm	h (mm)	U.Venta
66823	13,38	53x33	20	1

Muffin 6 cavidades

Muffin 6 cavités
 Muffinform 6 Madeleine
 Muffin 6 moulds
 Muffin 6 cavidades



Ref.	€	Ø (mm)	h (mm)	U.Venta
66805	13,38	70	40	1

Mini muffin 11 cavidades

Mini muffin 11 cavités
 Muffinform klein für 11 Madeleine
 Mini muffin 11 moulds
 Mini muffin 11 cavidades



Ref.	€	Ø (mm)	h (mm)	U.Venta
66804	13,38	50	28	1

Corazón 8 cavidades

Coeur 8 cavités
 Herzform 8 Madeleine
 Heart 8 moulds
 Coração 8 cavidades



Ref.	€	mm	h (mm)	U.Venta
66824	13,38	65x60	35	1

Rectángulo pequeño 20 cavidades

Petit rectangle 20 cavités
 Form rechteckig für 20 Madeleine
 Petit-four 20 moulds
 Rectángulo pequeno 20 cavidades



Ref.	€	mm	h (mm)	U.Venta
66825	13,38	49x26	11	1

Cake 12 cavidades

Cake 12 cavités
 Kuchenform 12 Madeleine
 Cake 12 moulds
 Cake 12 cavidades



Ref.	€	mm	h (mm)	U.Venta
66826	13,38	80x30	30	1

Petit four 15 cavidades

Petit four 15 cavités
Petits Fours 15 Madeleine
Petit four 15 moulds
Petit four 15 cavidades



Ref.	€	Ø (mm)	h (mm)	U.Venta
66827	13,38	40	20	1

Pomponette 24 cavidades

Pomponette 24 cavités
Pomponetteform 24 Madeleine
Pomponette 24 moulds
Pomponette 24 cavidades



Ref.	€	Ø (mm)	h (mm)	U.Venta
66828	13,38	34	16	1

Mini savarin 18 cavidades

Mini savarin 18 cavités
Savarinform 18 Madeleine
Mini savarin 18 moulds
Mini savarin 18 cavidades



Ref.	€	Ø (mm)	h (mm)	U.Venta
66808	13,38	41	12	1

Base esponjosa 3 cavidades

Base esponjosa 3 cavités
Kekform für 3 Madeleine
Sponge base 3 moulds
Base esponjosa 3 cavidades



Ref.	€	Ø (mm)	h (mm)	U.Venta
66830	13,38	103	20	1

Mini bordelais 18 cavidades

Mini bordelais 18 cavités
Mini Bordelaisform 18 Madeleine
Mini bordelais 18 moulds
Mini bordelais 18 cavidades



Ref.	€	Ø (mm)	h (mm)	U.Venta
66844	13,38	25	30	1

Molde Cake

Moule à cake
Kuchenform
Cake mould
Molde cake



Ref.	€	cm	h (cm)	U.Venta
66733	18,57	24x10	6,5	1
66742	20,34	28x10	7,0	1

Con anillo de refuerzo
With a reinforced ring

Molde savarin bajo

Moule Savarin bas
Savarinform, klein
Low Savarin mould
Molde pudim baixo



Ref.	€	Ø (cm)	h (mm)	U.Venta
66734	18,78	24	6,0	1

Con anillo de refuerzo
With a reinforced ring

Molde de flan 6 cav.

Moule à flan 6 cavités
Madeleine Backform für 6 Madeleine
Creme caramel 6 moulds
Molde de flan 6 cavidades



Ref.	€	cm	h (cm)	U.Venta
66736	18,78	29x19	5	1

Con anillo de refuerzo
With a reinforced ring

Molde savarin alto

Moule Savarin haut
Savarinform, gross
High Savarin mould
Molde pudim alto



Ref.	€	Ø (cm)	h (mm)	U.Venta
66735	20,44	23	10,50	1

Con anillo de refuerzo
With a reinforced ring

Molde redondo

Moule à manqué
Tortenform
Round cake mould
Molde redondo



Ref.	€	Ø (cm)	h (mm)	U.Venta
66737	18,26	24	4,5	1
66738	18,78	26	4,5	1

MOLDES DESMONTABLES



Molde 100% silicona antiadherente a prueba de goteo.
Base de cristal con recubrimiento antiadherente.
Perfecto para presentar en la mesa sobre la misma base.
Sistema de cierre seguro antiderrame. Ideal para pasteles y tartas delicadas.

Moule 100% silicone antiadhésif à l'épreuve de l'égouttement.
 Base en verre avec revêtement antiadhésif.
 Parfait pour une présentation à table sur la même base.
 Syst. de fermeture sûr et anti-écoulement, idéal pour les gâteaux et les tartes délicates.

Nicht tropfende Form aus 100% Silikon mit Antifaltbeschichtung.
 Glasplatte mit Antifaltbeschichtung.
 Eignet sich perfekt, um diese direkt auf der Glasplatte zu servieren.
 Sicheres Verschlusssystem mit Auslaufschutz. Ideal für leicht zerbrechliche Kuchen und Torten.

Non-stick, drip-proof 100% silicone mould.
 Glass base with non-stick, anti-scratch.
 Perfect for presenting at the table on its base.
 Secure anti-spill locking system. Ideal for delicate cakes and tarts.

Molde 100% de silicona antiadherente a prova de gotejo.
 Base de vidro com revestimento antiadherente.
 Perfecto para servir à mesa, sobre a própria base.
 Sistema de fecho seguro antiderrama. Ideal para pastéis e tartas delicadas.



Cerrar molde con pinza de sujeción
 Fermer le moule avec une pince de fixation.
 Form mit Befestigungsklemme schließen.
 Close mould with fastening clamp.
 Fechar o molde com a pinça de sujeição.



Verter masa en silicona a prueba de goteo
 Verser pâte dans silicone à l'épreuve de l'égouttement.
 Masse in abtropfendes Silikon geben.
 Pour dough in leak-proof silicone.
 Verter a massa em silicone à prova de gotejo.



Molde desmontable redondo

Moule démontable à manqué.
 Backform rund, zerlegbar.
 Round dismantlable mould.
 Molde desmontável redondo.



Ref.	€	Ø (cm)	h (cm)	L	U.Venta
66775	18,16	25	7,5	2,0	1



Se desmolda con suma facilidad, flexible

Démoulable très facilement, flexible.
 Sehr leichte Entformung, flexibel.
 Easily removed from mould, flexible.
 Desmolda-se facilmente, flexível.



Base de cristal antiadherente

Base en verre antiadhésive.
 Glasscockel Antifalt.
 Glass base non-stick.
 Base de vidro antiadherente.



Molde desmontable cake

Moule démontable à cake.
 Kuchenform, zerlegbar.
 Cake dismantlable mould.
 Molde desmontável cake.



Ref.	€	cm	h (cm)	L	U.Venta
66776	17,64	29x13	7,0	1,5	1



Molde desmontable cuadrado

Moule démontable à carré.
 Backform viereckig, zerlegbar.
 Square dismantlable mould.
 Molde desmontável quadrado.



Ref.	€	cm	h (cm)	L	U.Venta
66777	20,54	25x25	7,5	2,5	1

TAPETES · MOLDES · PLACAS HORNO



230°C
max

Set 12 moldes Muffin silicona

Set 12 moules Muffin en silicone
Set 12 Muffin formen, Silikon
Silicone 12 muffin moulds set
Conjunto 12 moldes Muffin en silicone



Ref	€	Ø (cm)	h (cm)	U.Venta
66745	4,57	7	5	1



30 macarons -> 5cm
48 macarons -> 4cm

230°C
max

Molde macarons doble

Moule macarons double
Moule Macaronsform
Macarons dual mould
Molde macarons duplo



Ref	€	cm	U.Venta
66753	10,27	39x29	1

Flexible, antiadherente y reutilizable
Flexible, non-stick and reusable



280°C
max

Tapete de silicona impreso

Tapis en silicone imprime
Bedruckte Silikonmatte
Printed silicon mat
Tapete de silicone impreso

Incluye - Includes:
1.- Tablas de conversión de temperatura (°C / °F)
2.- Peso (gr / oz)
3.- Volumen (ml / fl.oz 7 pc)
4.- Longitud (Inch / inch)
5.- Reglas laterales (cm / inch)

Ref	€	cm	U.Venta
66759	24,59	60x40	1

Flexible, antiadherente y reutilizable
Flexible, non-stick and reusable

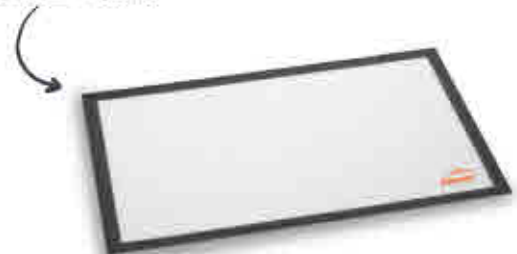

230°C
max

Tapete de silicona

Tapis en silicone
Backblech-Auflege Silikon
Silicone covering
Tapete de silicone

Ref	€	cm	U.Venta
66749	17,95	30x40	1
66731	24,90	60x40	1
66732	18,47	52x32 GN 1/1	1

Permite hornear sin necesidad de utilizar papel de horno
Lets you bake without having to use oven paper



Fibra de vidrio
250°C
max



Láminas antiadherentes

Feuilles antiadhésif
Antihalt-Blätter
Non-stick sheets
Láminas antiadherentes

Ref	€	cm	unidades	U.Venta
66746	8,09	30x40	3	1



Láminas de fibra de vidrio con recubrimiento antiadherente de gran calidad. Ideal para colocar sobre bandejas o parrillas de hornos y deshidratadores. Vida útil aproximadamente de 1000 hornados. Diseñadas para soportar temperaturas de hasta 250°C. Recortable para adaptar a cualquier recipiente. Reutilizables, para una correcta conservación se recomienda su lavado a mano. No aptas para lavavajillas.

Fibreglass sheets with non-stick coating high-quality. Ideal for placing on baking trays, oven racks and dehydrators. Can be used approximately 1,000 times. Designed to withstand temperatures up to 250°C. Can be cut to fit any container. Reusable; in order to keep the sheets in good condition, we recommend washing by hand. Non-dishwasher safe.



Molde de silicona Baguette
 Plaque à pain long en silicone
 Silikonbaguetteform
 Silicone Mould for long bread
 Molde silicone baguette

Si+Fibra
de vidrio
Silicone
+ Fiberglass

280°C
-40°C

Fabricado en fibra de vidrio, impregnado y revestido de silicona (según legislación Europea y Americana).
 Apto para el uso ultra congelación, fermentación y cocción de masa y pastas.

These molds are made of fiberglass filled and coated with silicon in accordance with European and American legislation.
 Apt for freezing at ultralow temperatures, fermentation and for the baking of doughs and pastries.

Ref	€	cm	Cavidades	U.Venta
67105	70,76	60x40	5	1

Inox



Parrilla
 Grille
 Gitter, Rost
 Grate
 Grelha

Ref	€	cm	h (cm)	U.Venta
68741	25,63	60x40	0,8	1

Inox



Parrilla
 Grille
 Gitter, Rost
 Grate
 Grelha

Ref	€	cm	Cubeta	U.Venta
66920	46,07	65X53	2/1	1
66921	17,64	53X32,5	1/1	1

AL

Aluminium



Placa horno aluminio antiadherente
 Plaque à four aluminium anti-adhésif teflon
 Backblech, Aluminium, Teflon
 Teflon non-stick coated oven aluminium tray
 Placa forno aluminio anti-adherente

Ref	€	cm	h (cm)	U.Venta
68660	30,81	60x40	1,0	1
68659	28,53	GN 1/1	1,0	1

Fe

Iron



Placa Horno acero negro
 Plaque à four tôle noire
 Backblech, Schwarzstahl
 Baking sheet black steel
 Placa de forno aço negro

Ref	€	cm	h (cm)	U.Venta
68640	31,23	60x40	1,0	1

Inox

Placa Horno
 Plaque à four
 Backblech
 Baking sheet
 Placa de forno

Ref	€	cm	h (cm)	U.Venta
68740	37,66	60x40	0,8	1
68739	29,15	GN 1/1	0,8	1

AL

Aluminium



Placa Horno
 Plaque à four
 Backblech
 Baking sheet
 Placa de forno

Ref	€	cm	h (cm)	U.Venta
68641	29,57	60x40	0,8	1
68642	23,86	GN 1/1	0,8	1

MOLDES INOX 18/10

Inox
18/10

240°C
max.



Cadena repostería

Chaîne pour pâtisserie
Kette für Konditorei
String for pastry
Corrente para pastelería



Ref	€	L (m)	U.Venta
68248	9,85	1,80	12

Flanero

Moule à flan
Pudding-/Becherförmchen
Pudding mould
Forma flan



Ref	€	Ø (cm)	h (cm)	U.Venta
60006	3,22	6	4,3	10
60007	3,74	7	5,0	10
60008	4,45	8	5,3	10

Inox



Molde cake liso

Moule à cake
Pastetenform
Cake mould plain
Molde cake liso

Ref	€	cm	h (cm)	U.Venta
65925	15,36	25x12	8,5	1
65930	18,36	30x12	8,5	1

Inox



Molde cake

Moule à cake
Pastetenform
Cake mould
Molde cake

Ref	€	cm	h (cm)	U.Venta
68726	13,59	25x12	8,5	1
68731	16,29	30x12	8,5	1
68735	19,40	35x12	8,5	1



Molde 1/2 caña desmontable redondo

Gouttière à bûche
Terrinen-/Kuchenform "Dachrinne"
Round cake mould
Molde 1/2 caña desmontável redondo

Ref	€	cm	h (cm)	U.Venta
68001	33,72	25x9	6,0	1
68002	42,23	50x9	6,0	1



Molde 1/2 caña desmontable triangular

Moule triangle "demi canne"
Terrinen-/Kuchenform "Dachrinne"
Three-cornered cake mould
Molde 1/2 caña desmontável triangular

Ref	€	cm	h (cm)	U.Venta
68003	33,51	25,5x9,4	9,4	1
68004	41,92	50,7x9,4	9,4	1

Marco rectangular

Rectangle
Rahmen, rechteckig
Rectangular frame
Molde rectangular



Ref	€	cm	h (cm)	U.Venta
68043	26,46	30x40	3,0	1
68048	26,66	31x48	3,0	1
68060	29,15	40x60	3,0	1
68041	26,66	30x40	5,0	1
68049	27,81	31x48	5,0	1
68061	30,19	40x60	5,0	1

Bandeja

Plaque
Backblech
Baking sheet
Bandeja



Ref	€	cm	h (cm)	U.Venta
68030	34,13	30x40	1,0	1
68031	34,55	31x48	1,0	1
68040	61,01	40x60	1,0	1

MOLDES ALUMINIO



Flanero

Moule à flan
Pudding-/Becherförmchen
Pudding mould
Forma flan



Ref	€	Ø (cm)	h (cm)	U.Venta
12406	1,25	6	4,9	24
12407	1,35	7	4,9	24
12408	1,56	8	5,0	24

Set 4 flaneros

Jeu 4 Moule à flan
4 Pudding-/Becherförmchen
4 pcs. pudding mould
Conjunto 4 formas flan



Ref	€	Ø (cm)	h (cm)	U.Venta
68808	11,93	8	5,2	6

Molde cake

Moule à cake
Kuchenform, konisch
Cake mould
Molde cake



Ref	€	L (cm)	h (cm)	U.Venta
68825	10,38	25	7	6
68831	12,24	30	7	6
68835	13,18	35	7	6

Molde alto

Moule à manqué
Käsekuchenform,
Pie mould
Molde alto



Ref	€	Ø (cm)	h (cm)	U.Venta
68822	8,72	22	4,7	6
68827	9,44	26	5,0	6
68829	10,89	30	5,0	6
68833	11,93	32	5,2	6

Molde rizado móvil

Moule à tarte fond mobile
Kuchenform, konisch
Fruit tart mould
Molde frizado-fundo móvil



Ref	€	Ø (cm)	h (cm)	U.Venta
68842	10,59	24	3	6
68882	14,11	28	3	6
68823	17,43	32	3	6

Molde rizado

Moule à brioche
Briocheform
Brioche mould
Molde flan frizado



Ref	€	Ø (cm)	h (cm)	U.Venta
68810	4,77	10	4,0	6
68814	6,43	14	5,5	6
68818	7,16	18	6,5	6
68821	9,75	22	10	6

Molde pizza

Moule à pizza
Pizzablech
Pizza mould
Molde pizza



Ref	€	Ø (cm)	h (cm)	U.Venta
68824	8,40	24	1,8	6
68828	9,03	28	1,8	6
68832	11,21	32	2,0	6
68836	12,66	36	2,0	6

Molde pizza perforado

Moule à pizza perforé
Pizzablech, gelocht
Perforated Pizza mould
Molde pizza perforado



Ref	€	Ø (cm)	h (cm)	U.Venta
67824	9,75	24	1,8	6
67828	10,27	28	1,8	6
67832	11,00	32	2,0	6
67836	11,62	36	2,0	6

Molde rizado

Moule à tarte fond fixe
Tortenbodenform, gewellter Rand
Tart mould
Molde frizado



Ref	€	Ø (cm)	h (cm)	U.Venta
68723	9,23	24	3,7	6
68729	10,48	28	3,7	6
68732	11,10	32	3,7	6

Molde savarin

Moule à Savarin
Reisrand/Savarinform
Savarin mould
Molde pudim



Ref	€	Ø (cm)	h (cm)	U.Venta
68724	14,53	24x6,5	5,7	6
68862	15,77	26x6,5	6,0	6
68863	15,98	28x6,5	6,0	6

▶ MOLDES ACERO CARBONO



Ideal para preparar todo tipo de postres, pudding, gelatinas o mousses, fríos o calientes.

Fabricados en acero al carbono.

Revestimiento antiadherente de gran calidad sin PFOA en el interior y el exterior. Distribuyen el calor de manera uniforme.

Asas de silicona resistentes al calor. Apto para hornos hasta 240°C.

No se recomiendan lavarlos en el lavavajillas.

Idéal pour préparer tout type de desserts, puddings, gelatines ou mousses, froids ou chauds.

Fabriqués en acier au carbone.

Revêtement antiadhésif de grande qualité sans PFOA à l'intérieur et à l'extérieur. Distribue uniformément la chaleur.

Poignées en silicone résistantes à la chaleur. Compatible avec les fours jusqu'à 240°C. Il est déconseillé de le laver au lave-vaisselle.

Idéal für alle Arten von Nachtisch, Pudding, Gelatine oder Mousse - kalt und warm. Aus Carbonstahl hergestellt.

Qualitätsvolle Antihaftbeschichtung ohne PFOA auf Innen- und Außenseite. Gleichmäßige Wärmeverteilung.

Hitzebeständige Silikongriffe. Backofenfest bis 240°C.

Vom Waschen in der Maschine wird abgeraten.

Idéal for making all types of hot or cold desserts, puddings, jellies or mousses.

Made of carbon steel.

High quality PFOA free non-stick coating on the inside and outside.

Distributes heat evenly.

Heat resistant silicone handles. Suitable for ovens up to 240°C.

Dishwasher use is not recommended.

Idéal para preparar todo o tipo de sobremesas, pudins, gelatinas ou mousses, frias ou quentes.

Fabricados em aço ao carbono.

Revestimento antiaderente de grande qualidade, sem PFOA no interior e no exterior. Distribuição uniforme do calor.

Asas de silicone resistentes ao calor. Aptos para fornos até 240°C.

Não é recomendável lavá-los na máquina de lavar louça.



Molde Cake
Moule à Cake
Kuchenform
Cake mould
Molde Cake

Ref	€	cm	h (cm)	L	U.Venta
68750	11,21	31x15,5	8,0	1,50	1



Molde redondo
Moule à manqué
Tortenform
Round cake mould
Molde redondo

Ref	€	Ø (cm)	h (cm)	L	U.Venta
68751	11,62	24	5,0	1,50	1



Molde cuadrado
Moule à carré
Quadratische Pfanne
Square cake mould
Molde cuadrado

Ref	€	cm	h (cm)	L	U.Venta
68752	11,93	23x23	5,0	2,00	1



Molde rectangular
Moule à rectangulaire
Rechteckig Pfanne
Rectangular mould
Molde rectangular

Ref	€	cm	h (cm)	L	U.Venta
68753	11,00	34x24	2,0	1,40	1



Molde Muffin (6 Cav.)

Moule à Muffin
Muffinform
Muffinmould
Moide Muffin

Ref	€	Cav. (cm)	ml	U.Venta
68754	12,14	7x3	73 (cav.)	1



Molde 12 cavidades madalenas

Plaque madeleine 12 alveoles
Muffinform 12 Madeleine
12 cups madelaine pan
Moide cavidades 12 madalenas

Ref	€	cm	h (cm)	U.Venta
68000	13,18	39,8x19,5	2,0	1



Molde 12 cavidades

Plaque à biscuits 12 alveoles
Madeleine-Backform für 12 Madeleine
12 cups muffin pan
Moide 12 cavidades

Ref	€	cm	h (cm)	U.Venta
68010	15,56	35x26,5	3,0	1



Molde cake chapa antiadherente

Moule à cake tôle anti-adh.
Back/Pastetenform, Antihalt
Cake mould rolled B.S. non s.
Moide cake chapa aderente

Ref	€	cm	h (cm)	U.Venta
68725	7,47	25x12	8,5	6
68730	7,78	30x12	8,5	6
68735	8,51	35x12	8,5	6



Molde desmontable redondo chapa antiad.

Moule rond desmontable
Tortenbodenform
Dismountable round mould
M. desmontável redondo chapa anti-aderente

Ref	€	Ø (cm)	h (cm)	U.Venta
68714	9,23	24	7	1
68716	9,75	26	7	1
68718	9,86	28	7	1

Juego 4 cornetes chapa antiadherente

Ensemble de 4 moule cornet antiadhesive
Hornförmchen 4-tlg. antihalt
4 pcs. non stick cream horn set
Jogo 4 forma de cornucópia anti-aderente

Ref	€	cm	U.Venta
68936	5,71	12	6



▶ MOLDES BOMBÓN



Molde profesional para elaborar deliciosos y originales bombones.
Fabricado en Poliestireno de alta calidad.

Se obtienen bombones perfectos y con un brillo único.

Cómodo de utilizar: Rellena el molde con chocolate fundido, retira el exceso de chocolate, deja reposar, vuelca el molde y da un pequeño golpe para que salgan los bombones.

Fácil de limpiar y resistentes al uso diario.

Superficie lisa para un mejor desplazamiento de la espátula a la hora de retirar el chocolate sobrante.

Disponibles en 10 modelos distintos.

Moule professionnel pour élaborer de délicieux et originaux chocolats.

Fabriqu  en polystyr ne de grande qualit .

Permet d'obtenir des chocolats parfaits avec une brillance unique.

Facile   utiliser : Remplir le moule de chocolat fondu, retirer l'exc s de chocolat, laisser reposer, retourner le moule et tapoter l g rement pour faire sortir les chocolats.

Facile   nettoyer et r sistant   l'usage quotidien.

Surface lisse pour un meilleur mouvement de la spatule lors du retrait du chocolat exc dentaire.

Disponibles en 10 mod les diff rents.

Professionelle Gie form zum Herstellen Ihrer eigenen leckeren Pralinen.

Aus hochwertigem Polystyrol.

Formt perfekte Pralinen mit besonders glanzvoller Oberfl che.

Leichte Anwendung: Geschmolzene Schokolade in Gie form einflie en.

Schokoladenreste entfernen, ruhen lassen, Gie form umdrehen und Pralinen durch leichtes Klopfen herausl sen.

Langlebig und leicht zu reinigen.

Dank der glatten Oberfl che lassen sich Schokoladenreste leicht mit einem Spachtel entfernen.

In 10 verschiedenen Formen erh tlich.

Professional mould for making delicious and original chocolates.

Made of high quality polystyrene.

Makes perfect chocolates with a unique shine.

Easy to use: Fill the mould with melted chocolate. Remove the excess chocolate. Let sit. Flip the mould over and tap gently to get the chocolates out.

Easy to clean and stands up to daily use.

Smooth finish so a spatula will slide easily over the surface when removing extra chocolate.

Available in 10 different models.

Molde profissional para elaborar deliciosos e originais bombons.

Fabricado em Poliestireno de alta qualidade.

Permite obter bombons perfeitos e com um brilho  nico.

F cil de utilizar: encha o molde com chocolate fundido, retire o excesso do chocolate, deixe repousar, vire o molde e d  um pequeno golpe para que os bombons se soltem.

F cil de limpar e resistente ao uso di rio.

Superf cie lisa para uma melhor desloca o da esp tula ao retirar o chocolate sobrando.

Dispon vel em 10 modelos distintos.

Dimensiones / Sizes

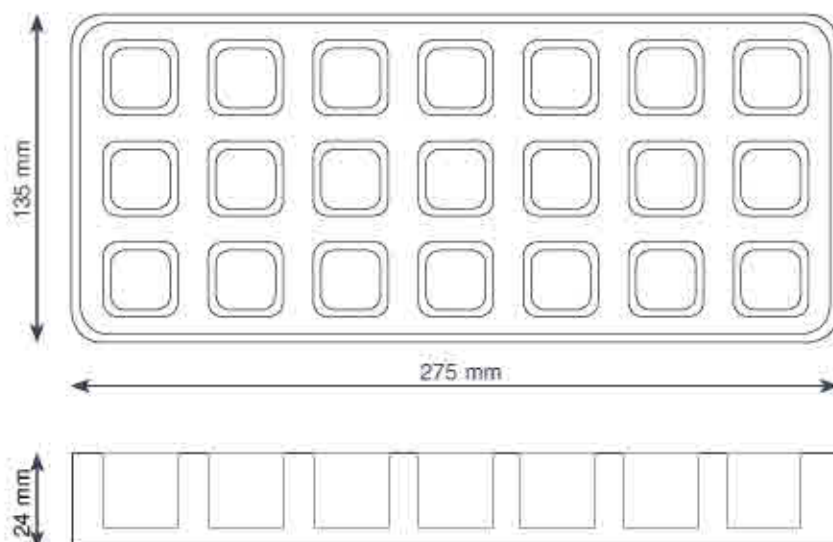



Molde bombón Semiesférica

Moule pour chocolats Hemisphere
Halbkugelform Praliniengießform
Half-sphere chocolate mould
Molde para bombons Semi-esférica

Ref	€	Ø (mm)	h (mm)	ml	U.Venta
66870	15,36	28	19	7	1



Molde bombón Corazón

Moule pour chocolats Coeur
Herzform Praliniengießform
Heart chocolate mould
Molde para bombons Coração

Ref	€	mm	h (mm)	ml	U.Venta
66871	15,36	25x20	11,5	6	1

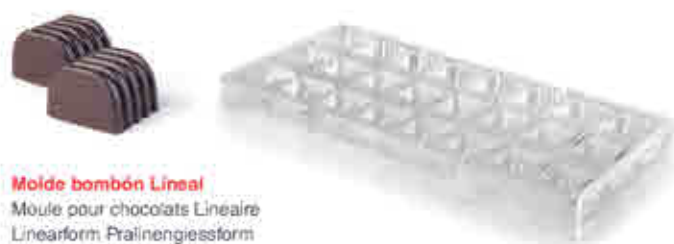

Molde bombón Lineal

Moule pour chocolats Lineaire
Linearform Praliniengießform
Linear chocolate mould
Molde para bombons Linear

Ref	€	mm	h (mm)	ml	U.Venta
66872	15,36	25,5x24,5	17	10	1



Molde bombón Oval

Moule pour chocolats Ovale
Ovalform Praliniengießform
Oval chocolate mould
Molde para bombons Oval

Ref	€	mm	h (mm)	ml	U.Venta
66873	15,36	30x18	19	8	1



Molde bombón Cuadrado

Moule pour chocolats Carree
Praliniengießform, viereckig
Square chocolate mould
Molde para bombons cuadrado

Ref	€	mm	h (mm)	ml	U.Venta
66874	15,36	25x25	17	10	1



Molde bombón Hoja

Moule pour chocolats Feuillere
Blatt Praliniengießform
Leaf chocolate mould
Molde para bombons folha

Ref	€	mm	h (mm)	ml	U.Venta
66875	15,36	32x19	12	6	1



Molde bombón rectangular

Moule pour chocolats Rectangulaire
Praliniengießform, rechteckig
Rectangular chocolate mould
Molde para bombons Rectangular

Ref	€	mm	h (mm)	ml	U.Venta
66876	15,36	25x15,5	12	6	1



Molde bombón Ondulado

Moule pour chocolats Ondulé
Onduliert Praliniengießform
Ondulated chocolate mould
Molde para bombons Ondulado

Ref	€	mm	h (mm)	ml	U.Venta
66877	15,36	32x25	12,5	7	1



Molde bombón Prisma

Moule pour chocolats Prisme
Prisma Praliniengießform
Prism chocolate mould
Molde para bombons Prisma

Ref	€	mm	h (mm)	ml	U.Venta
66878	15,36	35x16	17	8	1



Molde bombón Cónica

Moule pour chocolats Conique
Praliniengießform, Konisch
Conical chocolate mould
Molde para bombons Conica

Ref	€	Ø (mm)	h (mm)	ml	U.Venta
66879	15,36	25,5	19	6	1

Inox

Aro redondo

Cercle rond
Kuchen-/Ausstechformen, rund
Round cake ring
Aro redondo



Ref	€	Ø (cm)	h (cm)	U.Venta
68406	2,59	6	4	12
68407	2,70	7,5	4	12
68408	2,80	8	4	12
68410	2,91	10	4	12
68412	4,57	12	4	12
68414	4,25	14	4	6
68416	5,81	16	4	6
68418	6,95	18	4	6
68420	8,40	20	4	1
68422	8,51	22	4	1
68424	9,65	24	4	1

Inox

Aro redondo Entremet

Cercle rond Entremet
Kuchen-/Ausstechformen, rund, Entremet
Round cake ring Entremet
Aro redondo Entremet



Ref	€	Ø (cm)	h (cm)	U.Venta
68308	2,70	8	3,5	12
68310	2,70	10	3,5	12

Inox

Aro redondo Mousse

Cercle rond Mousse
Kuchen-/Ausstechformen, rund, Mousse
Round cake ring Mousse
Aro redondo Mousse



Ref	€	Ø (cm)	h (cm)	U.Venta
68506	2,59	6	4,5	12
68508	2,70	8	4,5	12
68509	2,80	9	4,5	12
68510	2,91	10	4,5	12
68512	3,63	12	4,5	12
68514	4,25	14	4,5	12
68516	5,91	16	4,5	6
68518	6,85	18	4,5	6
68520	7,47	20	4,5	6
68522	8,72	22	4,5	1
68524	9,03	24	4,5	1
68526	9,96	26	4,5	1

Inox 18/10

Aro tarta borde vuelto

Cercle "goutte"
Tortenring
Tart ring
Aro tarta

Ref	€	Ø (cm)	h (cm)	U.Venta
68107	3,11	8	2,2	6
68121	3,32	10	2,2	6
68120	6,54	20	2,2	1



Inox

Aro redondo Vacherin

Cercle rond Vacherin
Kuchen-/Ausstechformen, rund, Vacherin
Round cake ring Vacherin
Aro redondo Vacherin



Ref	€	Ø (cm)	h (cm)	U.Venta
68607	3,63	7	6	12
68608	3,74	8	6	12
68609	3,84	9	6	12
68610	3,94	10	6	12
68612	5,29	12	6	6
68614	6,23	14	6	6
68616	8,40	16	6	6
68618	9,44	18	6	1
68620	12,24	20	6	1
68622	13,07	22	6	1
68624	14,11	24	6	1
68626	15,04	26	6	1
68628	16,39	28	6	1

Inox

Aro repostería extensible

Cercle extensible
Kuchenform, verstellbar
Adjustable pastry ring
Aro extensible pastelería



Ref	€	Ø (cm)	h (cm)	U.Venta
68200	15,36	15-30	7,0	1

Inox 18/10

Juego aros repostería (4 pcs)

Ensemble de cercies à pâtisserie
Ausstechformen, Set
Pastry rings set
Jogo aros de pastelería



Ref	€	Forma	cm	h (mm)	U.Venta
68203	9,34	Redondo/Round	Ø7,7	5	1
		Redondo/Round	Ø10,7	5	
		Cuadrado/Square	8,2x8,2	5	
		Triángulo/Triangle	6x6	5	

Inox
18/10

Molde cuadrado

Carre pour pâtisserie
Kuchen-/Ausstech formen, viereckig
Square pastry mould
Molde quadrado



Ref	€	cm	h (cm)	U.Venta
68460	4,05	6x6	4	12
68480	4,15	8x8	4	12
68411	4,25	10x10	4	12
68441	4,57	14x14	4	6
68240	5,71	20x20	4	6



Inox
18/10

Empujador aro repostería

Poussoir inox pour cercles à pâtisserie
Andrückler für Kuchenformen
St. Steel pusher for pastry ring
Empurrador para aro de pastelaria

Ref	€	cm	U.Venta
68890	9,34	7x16,2	1



▶ AROS PERFORADOS



Innovadores aros de acero inoxidable microperforados. Disponibles en distintas formas y tamaños. Ideales para masa brisa, hojaldre y choux. Las microperforaciones permiten la circulación de aire durante la cocción, consiguiendo una cocción más rápida y homogénea.

Cercle en acier inoxydable micro-perforé innovant. Disponible en plusieurs formes et tailles. Idéal pour la pâte brisée, la pâte feuilletée et la pâte à choux. Les micro-perforations permettent la circulation d'air pendant la cuisson, obtenant ainsi une cuisson plus rapide et homogène.

Innovativer mikroperforierter Edelsstahling. In verschiedenen Formen und Größen verfügbar. Ideal für Mürbeteig, Blätterteig und Brandmasse. Die Mikroperforierungen erlauben die Luftzirkulation während des Backens und erzielen eine schnellere und gleichmäßigere Gärung.

Innovative microperforated stainless steel (art) ring. Available in various different shapes and sizes. Ideal for shortcrust, puff and choux pastry. The microperforations enable air to circulate during cooking, ensuring faster and more even cooking.

Inovador aro de aço inoxidável microperforado. Disponível em diferentes formas e tamanhos. Ideal para massa quebrada, folhados e choux. As microperforações permitem a circulação de ar durante a cocção, tornando-a mais rápida e homogênea.

Inox
18/10

Aro redondo perforado

Cercle rond perforé
Kuchen-/Ausstechformen, rund, gelocht
Perforated round cake ring
Aro redondo perforada



Ref	€	Ø (cm)	h (cm)	U.Venta
68537	2,70	7	2,0	6
68536	4,36	16	2,0	6
68538	4,77	18	2,0	6
68540	5,50	20	2,0	6
68544	6,54	24	2,0	6
68547	3,74	7	3,5	6
68546	6,64	16	3,5	6
68548	7,47	18	3,5	6
68550	8,30	20	3,5	6
68554	9,95	24	3,5	6

Inox
18/10

Aro cuadrado perforado

Cercle carré perforé
Kuchen-/Ausstechformen, viereckig, gelocht
Perforated square cake ring
Aro cuadrado perforada



Ref	€	cm	h (cm)	U.Venta
68557	3,22	7x7	2,0	6
68556	5,29	16x16	2,0	6
68560	6,54	20x20	2,0	6
68567	4,36	7x7	3,5	6
68566	8,30	16x16	3,5	6
68570	10,17	20x20	3,5	6

Inox
18/10

Aro rectangular perforado

Cercle rectangulaire perforé
Kuchen-/Ausstechformen, rechteckig, gelocht
Perforated rectangular cake ring
Aro rectangular perforada



Ref	€	cm	h (cm)	U.Venta
68590	4,57	7x20	2,0	6
68598	5,60	8x28	2,0	6
68591	6,85	7x20	3,5	6
68597	9,03	8x28	3,5	6

Inox
18/10

Aro oval perforado

Cercle oval perforé
Kuchen-/Ausstechformen, oval, gelocht
Perforated oval cake ring
Aro oval perforada



Ref	€	cm	h (cm)	U.Venta
68580	4,36	7x20	2,0	6
68588	5,50	8x28	2,0	6
68581	6,33	7x20	3,5	6
68587	8,61	8x28	3,5	6





ELÉCTRICO ELECTRIC

Eléctrico
Electric

Calentadores
Lamps



Incluye RECETARIO
RECIPE BOOK included

Diseñado para hacerte el día a día más fácil en tu cocina.
Realiza todas tus recetas de manera rápida y sin esfuerzo.
Múltiples funciones: cocer, sofreír, picar, triturar, cocer al vapor, mezclar, batir, amasar, emulsionar y pesar, solo tienes que darle la orden.
Panel de control de fácil manejo.
Incluye accesorios para elaborar todo tipo de recetas.

Conçu pour vous faciliter la tâche dans votre cuisine quotidienne.
Il réalise toutes les recettes de manière rapide et sans effort.
Multiples fonctions : cuire, sauté, hacher, broyer, cuire à la vapeur, mélanger, mixer, pétrir, émulsionner et peser, vous n'avez qu'à lui donner l'ordre.
Tableau de commande facile à manœuvrer.
Il inclut les accessoires pour élaborer tout type de recettes.

Macht das Leben in der Küche leichter.
Alle Rezepte lassen sich schnell und einfach zubereiten.
Multifunkt mit vielen Funktionen: kochen, anbraten, zerkleinern, mahlen, dampfgaren, vermischen, mixen, kneten, emulgieren und wiegen auf Knopfdruck möglich.
Übersichtliches Bedienfeld.
Mit komplettem Zubehör.

Designed to make everyday life easier in your kitchen.
Makes all your recipes quickly and effortlessly.
Multiple functions: cook, sauté, chop, shred, steam, mix, beat, knead, emulsify and weigh, you just have to give the order.
Easy-to-use control panel.
Includes accessories to make all kinds of recipes.

Concebido para tornar mais fáceis as tarefas da cozinha.
Elabora todas as tuas receitas de maneira rápida e sem esforço.
Várias funções: cozer, refogar, picar, tritura, cozer a vapor, misturar, bater, amassar, emulsionar e pesar.
Panel de controlo fácil de utilizar.
Inclui acessórios para elaborar todo o tipo de receitas.

TODO EN UNO - ALL-IN-ONE



CookingMe

Ref	€	U.Venta	
69561E	752,19	1	CookingMe + Recetario en ESPAÑOL - Recipe book in SPANISH
69561F	752,19	1	CookingMe + Recetario en FRANCÉS - Recipe book in FRENCH
69561I	752,19	1	CookingMe + Recetario en INGLÉS - Recipe book in ENGLISH

Ref	Tensión/Voltage	Potencia/Power	Velocidad/Speed	Temp./Temp.	Capacidad/capacity	Funciones/Memorias/Functions/Memories	Báscula/Scale	Dimensiones/Sizes	Peso/Weight
69561E		Motor: 1000 W Calent. Heating: 1000 W	60 - 10.000 rpm	37°C - 120°C	2,0 L	15 / 3	5 Kg (div. 1 g)	39x30x33 cm	7,80 Kg

Accesorios

Accessoires · Zubehör · Accessories · Acessórios

Recetario

Cookbook
Kochbuch
Cookbook
Livro de receitas



Ref	€	U.Venta	
R69561N	27,49	1	Español
R69561P	27,49	1	Français
R69561Q	27,49	1	Inglés

Jarra

Pitcher
Kanne
Picher
Jarra



Ref	€	L	U.Venta
R69561A	159,78	2,0	1

Tapa para jarra

Couvercle pour picher
Deckel für Kanne
Lid for picher
Tampa para jarra



Ref	€	U.Venta
R69561E	12,97	1

Vaso dosificador

Verre doseur
Dosierbecher
Measuring glass
Copo dosificador



Ref	€	ml	U.Venta
R69561W	2,18	100	1

Cestillo colador

Panier passoire vapeur
Dampfsieb
Steam strainer basket
Cesto coador



Ref	€	U.Venta
R69561C	15,56	1

Anilla fijación / bloqueo

Anneau de fixation / verrouillage
Dichtungsring / Arretierung
Fixing ring
Anilha de fixação / bloqueio



Ref	€	U.Venta
R69561Z	2,18	1

Cuchillas

Couteaux
Klinge
Blades
Lâminas



Ref	€	U.Venta
R695618	31,13	1

Amasador

Accessoire à pétrir
Knetzeinsatz
Kneader
Acessório para amassar



Ref	€	U.Venta
R69561V	25,73	1

Emulsionador

Fouet
Rühraufsatz (Schmetterlig)
Emulsifier
Batedor de borboleta



Ref	€	U.Venta
R69561T	4,25	1

NO apta para el lavavajillas
NOT dishwasher safe

NO INCLUIDA
NOT INCLUDED

Espátula

Spatule
Kelle
Spatula
Espátula



Ref	€	U.Venta
R69561S	6,43	1

Báscula

Balance
Waage
Scale
Balança



Ref	€	Kg	U.Venta
R69561F	28,01	5,0	1

Vaporera

Ensemble vapeur
Dampfeinsatz
Steam
Conjunto de vapor



Ref	€	U.Venta
R69561D	74,70	1

Accesorios aptos para la limpieza en el lavavajillas

Accessoires adaptés au nettoyage au lave-vaisselle · Zubehör angepasst für in der Spülmaschine reinigen · Accessories suitable for cleaning in the dishwasher · Acessórios adaptado para a limpeza na máquina de lavar



Pan y masas
Bread and pasta



Salsas
Sauces



Sopas
Soups



Verduras
Vegetables



Pescados
Fish



Carnes
Meats



Bebidas
Drinks



Postres
Desserts

▶ OLLA PROGRAMABLE

- Household use -



Haz todo lo que te propongas
Faites tout Do everything you want to do



Herméticamente sellada para obtener una mejora del sabor sin perder nutrientes. Pantalla LCD, táctil y en dos idiomas (Castellano e inglés). Multifunción: 20 Funciones.

Hermétiquement scellée pour obtenir une meilleure saveur sans perdre les nutriments. Écran LCD, tactile et en deux langues (Espagnol et anglais.) Multifonction: 20 fonctions.

Hermétisch abgedichtet für einen besseren Geschmack ohne Nährstoffverluste. LCD-Touch-Screen zweisprachig (Spanisch und Englisch) Multifunktion: 20 Funktionen.

Hermetically sealed to give an improved flavour without losing nutrients. LCD touch screen in two languages (Spanish and English) Multifunction: 20 function.

Hermeticamente selada, para conservar o sabor sem perder os nutrientes. Ecrã LCD, tátil e em dois idiomas (espanhol e inglês). Multifunção: 20 funções.



Potajes
Potages



Carnes
Meats



Pescados
Fish



Postres
Desserts



Yogurt
Yoghurt



Mermeladas
Jam



Olla programable
Cocotte programmable
Programmierbarer Kochtopf
Programmable cooker
Panela programável

Ref	€	W	L	U.Venta
69335	195,26	950	5,0	1

Incluye accesorios para yogur, cestillo freidora, vaso medidor, cuchara, espátula/pinza y bandeja cocción al vapor
Includes accessories for yoghurt, fryer basket, measuring cup, spoon, spatula/long and steaming pan



Ref	Tensión/Voltage	Potencia/Power	Temperatura/Temp.	Capacidad/Capacity	Dimensiones/Sizes	Peso/Weight
69335	220-230 V. 50/60 Hz	950 W	35°C -180°C	5,0 L	30x26,5x26 cm	6,50 Kg

YOGURTERAS

- Household use -



Disfruta de yogures más sanos y naturales
Enjoy healthier and more natural yoghurt



Yogurtera de vasos MULTI

Yaourtiers à pots
Joghurt-Maker mit Glasbehältern
Yoghurt maker with jars
Iogurteira de frascos

Ref	€	W	U.Venta	
69245	39,11	20	1	
69244	9,34	-	7	Set 7 tarros cristal - Set 7 glass jar
R692458	1,35	-	7	Tarro de cristal - glass jar



Incluyen **RECETARIO**
RECIPE BOOK included

Elabora deliciosos yogures caseros del sabor y textura que te apetezca.
Es muy sencillo de utilizar.
Tiempo de preparación de 8 -14 h.
Disfruta de yogures naturales y saludables generando menos residuos.
Fácil de limpiar.

Élaborez de délicieux yaourts maison avec le goût et la texture que vous préférez.
Cet appareil est très facile à utiliser.
Durée de préparation : 8 - 14 h
Savourez des yaourts naturels et sains tout en générant moins de déchets.
Appareil facile à nettoyer.

Zum Herstellen leckerer Joghurts mit Zutat und Konsistenz nach Ihrem Geschmack.
Einfache Bedienung mit nur einem Knopf.
Dauer 8 -14 Std.
Genießen Sie natürliche und gesunde Joghurts ohne viel Abfall zu produzieren.
Einfach zu reinigen.

Make delicious home-made yoghurt with the flavour and texture you want.
Because it only has one button, it's easy to use.
Preparation time 8 - 14 h
Enjoy healthier and more natural yoghurt while generating less waste.
Easy to clean.

Elabora deliciosos iogurtes caseiros, com o seu sabor e textura preferidos.
Fácil de utilizar.
Tempo de preparação máximo de 8 - 14 h
Desfruta de iogurtes naturais e saudáveis, gerando menos resíduos.
Fácil de limpar.



Filtro para yogur griego y queso fresco
Filter for greek yoghurt and fresh cheese

Yogurtera WHITE

Yaourtiers
Joghurt-Maker
Yoghurt maker
Iogurteira

Ref	€	W	U.Venta
69246	34,03	20	1



Ref	Tensión/Voltage	Potencia/Power	Temporizador/Timer	Capacidad/Capacity	Dimensiones/Sizes	Peso/Weight
69245	220-240 V; 50/60 Hz	20 W	1 - 14 h	190 ml	Ø25x12 cm	1,80 Kg
69246	220-240 V; 50/60 Hz	20 W	-	1,0 L (Filtro - Filter) 1,6 L (Pequeño - Small) 1,8 L (Grande - Big)	18x16x24 cm	0,85 Kg

▶ MÁQUINA DE HELADO

- Household use -



Dispone de un vaso medidor
y una cuchara racionador de helado
Comes with a measuring cup and
an ice cream scoop



Máquina de helado
Machine de crème glacée
Eis Maschine
Ice cream machine
Máquina de gelado

En 60 minutos obtendrá
un nutritivo helado
Nutritious ice cream in 60 minutes



Incluye **RECETARIO**
RECIPE BOOK included

Una nueva forma de hacer helado cremoso y saludable
Puedes realizar infinidad de helados de: fresa, plátano, kiwi, mango, piña, melón, etc.
Ideal para dietas especiales: sin leche, sin azúcar, sin gluten

Une nouvelle façon de faire des glaces crémeuses et saines
Vous pouvez réaliser une infinité de glaces : à la fraise, à la banane, au kiwi, à la mangue, à l'ananas, à l'orange, au melon, etc.
Idéal pour les régimes alimentaires spéciaux : sans lait, sans sucre, sans gluten

Eine neue Art cremiges und gesundes Eis herzustellen.
Sie können unzählige Eisorten herstellen: Erdbeere, Banane, Kiwi, Mango, Ananas, Orange, Melone usw.
Ideal für besondere Ernährungsweisen: ohne Milch, ohne Zucker, glutenfrei

A new way to make creamy and healthy ice cream
You can make a wide variety of ice creams: strawberry, banana, kiwi, mango, pineapple, orange, melon, etc.
Ideal for special diets: milk-free, sugar-free, gluten-free

Uma nova maneira de elaborar um gelado cremoso e saudável
Podes preparar uma grande variedade de gelados de morango, banana, kiwi, mango, ananás, laranja, melão, etc.
Ideal para dietas especiais: sem leite, sem açúcar, sem glúten

Helados 100% naturales
Disfruta de helados saludables y bajos en calorías
100% natural ice creams
Enjoy healthy, low-calorie ice creams

Ref	€	U. Venta
69315	402,86	1

Ref	Tensión/Voltage	Potencia/Power	Temperatura/Temp.	Capacidad/Capacity	Tiempo/Timer	Dimensiones/Sizes	Peso/Weight
69315	220-240 V / 50 Hz	150 W	-18°C / -35°C	1,40 L	60 min	38x29x31 cm	10,30 Kg

▶ BATIDORA VARILLAS

- Household use -



Batidora de varillas HOME
Batteur à main
Handmixer
Hand mixer
Batedor de mão

Ref	€	W	U. Venta
69384	40,57	300	1



Silenciosa, ligera y extremadamente potente para una mayor comodidad durante el uso.
Mejores resultados en menos tiempo gracias a su motor de gran potencia.
5 niveles de velocidad + función turbo. Empuñadura ergonómica con SoftTouch.

Silencieux, léger et extrêmement puissant pour une utilisation plus confortable.
Meilleurs résultats en moins de temps grâce à son moteur de grande puissance.
5 niveaux de vitesse + fonction turbo. Poignée ergonomique avec SoftTouch.

Leise, leicht und extrem leistungsstark für eine bequeme Benutzung.
Optimale Ergebnisse in kürzerer Zeit, dank seines leistungsstarken Motors.
5 Geschwindigkeiten + Turbofunktion. Ergonomischer Griff mit SoftTouch.

Silent, lightweight and extremely powerful for greater comfort during use.
Better results in less time thanks to its powerful motor.
5 speeds + turbo function. SoftTouch ergonomic handle.

Silenciosa, leve e extremamente potente para um maior conforto durante a utilização.
Melhores resultados em menos tempo graças ao seu motor de grande potência.
5 níveis de velocidade + função turbo. Cabo ergonómico com SoftTouch.

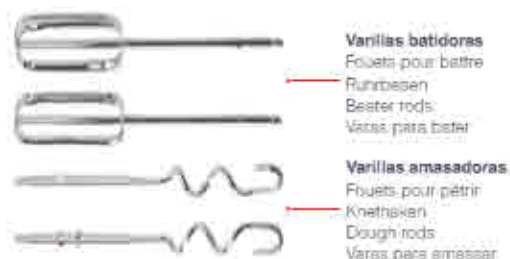

Ref	Tensión/Voltage	Potencia/Power	Velocidad/Speed	Capacidad/Capacity	Dimensiones/Sizes	Peso/Weight
69384	220-240 V; 50/60 Hz	300 W	5 + TURBO	1000 g	18x8x14 cm	1,20 Kg

BATIDORAS-AMASADORAS



Batir, mezclar y amasar productos para la preparación de alimentos. Velocidad regulable, doble movimiento de giro, rotativo y orbital. Brazo basculante para acoplar los distintos accesorios.

Batire, mélanger et pétrir des produits pour la préparation d'aliments. Vitesse réglable, double mouvement de rotation, rotatif et orbital. Bras pivotant pour fixer aisément les différents accessoires.

Schlagen, Mischen und Kneten von Produkten zur Zubereitung von Nahrungsmitteln. Regelbare Geschwindigkeit, doppelte Drehbewegung, rotatorisch und orbital. Schwenkarm um die verschiedenen Zubehörfteile einzustecken.

Beat, mix and knead products to food preparation. Adjustable speed, double twisting, rotating and orbital motion. Swing arm for connection of different accessories.

Bater, misturar e amassar produtos para a preparação de alimentos. Velocidade regulável, duplo movimento rotativo e orbital. Braço basculante para acoplar os diferentes acessórios.



Tapa transparente anti-salpicaduras con ventana
Transparent anti-splatter lid with opening

Brazo basculante de 35°
35° swing arm

1,2 Kg de cap. para el amasado
1,2 kg mixer capacity



DC  Professional use

Batidora amasadora PROFESIONAL

Batteur pétrisseur
Mix- und knetmaschine
Mixer-kneader
Batedeira amassadora

Ref	€	W	L	U.Venta
69084	758,41	300	5,0	1

AC  Household use

Batidora amasadora GOURMET

Batteur pétrisseur
Mix- und knetmaschine
Mixer-kneader
Batedeira amassadora

Ref	€	W	L	U.Venta
69388	185,51	600	4,0	1

Ref	Tensión/Voltage	Potencia/Power	Velocidad/Speed	Velocidad/Speed	Capacidad/Cap.	Dimensiones/Sizes	Peso/Weight
69084	220-240 V; 50/60 Hz	300 W	3	130 - 850 r.p.m	5,0 L	23x14,5x41 cm	19 Kg
69388	220-240 V; 50/60 Hz	600 W	6	80 - 180 r.p.m	4,0 L	35x22x30 cm	4,40 Kg

Multifuncional: 3 máquinas en una
Multifunctional: 3 machines in one

Batidora · amasadora + Picadora · Embutidos · Kibbe + Jarra batidora (1,5L)
Mixer-kneader + Chopper Sausages-Kibbe + Blender jug

3 in 1



Accesorios NO incluidos · Accessories NOT included

Accesorio Jarra
Accessoire cruche
Krugzubehör
Jug Accessory
Acessório de jarro



Ref	€	L	U.Venta	
A 69584	24,59	1,5	1	Para la batidora amasadora DELICY
B 69684	24,59	1,5	1	Para la batidora amasadora COMPLET

Accesorio Picadora/Embutidora/Kibbe
Accessoire Hachoir / Stuffer / Kibbe
Fleischwolf / Wurstfüller / Kibbe Zubehör
Chopper / Stuffer / Kibbe accessory
Acessório Picador / Stuffer / Kibbe



Ref	€	L	U.Venta
69685	51,98	1,5	1

New

Velocidades
5+PULSE
Speeds



Batidora amasadora DELICY
Batteur pétrisseur
Mix- und Knetmaschine
Mixer-kneader
Batedeira amasadora

Ref	€	W	L	U.Venta
69583	320,17	1000	5,0	1

Amasado con movimientos planetarios. Doble movimiento de giro, rotatorio y orbital.
Mecanismo de engranajes metálicos.
Brazo basculante de 35° para acoplar los distintos accesorios.
Bol de acero inoxidable 18/10 de 5 L (69583) / 6 L (69683) de capacidad.
Tapa transparente anti-salpicaduras con ventana para añadir ingredientes durante el uso.
3 accesorios para batir, mezclar y amasar.
Recubrimiento antiadherente de los accesorios mezclador y amasador para evitar que los alimentos se peguen.
Ventosas de sujeción para una perfecta estabilidad.
Accesorios no incluidos (jarra y picadora) compatibles para conseguir un robot multifuncional.

Pétrissage avec des mouvements planétaires. Double mouvement de rotation, rotatoire et orbital.
Mécanisme d'engrenages métalliques.
Bras pivotant de 35° pour fixer aisément les différents accessoires.
Bol en acier inoxydable 18/10 d'une capacité de 5 L (69583) / 6 L (69683).
Couvercle transparent anti-éclaboussures avec fenêtre pour ajouter les ingrédients pendant l'utilisation.
3 accessoires pour battre, mixer et pétrir.
Revêtement antiadhésif de l'accessoire pour mélanger et pétrir afin d'éviter que les aliments collent.
Ventouses de fixation pour une bonne stabilité.
Accessoires non inclus (bol et hachoir) compatibles pour obtenir un robot multifonctions.

Geschwindigkeitsregler für 6 Stufen und PULSE (Turbo).
Planeten-Rührsystem. Doppelte Dreh-, Rotations- und Planetarbewegung.
Mechanismus von Metallzahnradern.
Im 35° Winkel schwenkbarer Arm, um die verschiedenen Accessories anzuschließen.
Edelstahlschüssel 18/10 mit 5 l (69583) / 6 l (69683) Fassungsvermögen.
Durchsichtiger Deckel gegen Spritzer mit Fenster zur Zugabe von Zutaten.
3 Accessories zum Schlagen, Rühren und Kneten.
Zubehör zum Mixen und Kneten mit Antihaftbeschichtung – nichts bleibt kleben.
Saugnapfe für eine bessere Stabilität.
Wird durch weiteres Zubehör (Mixbehälter und Fleischwolf – nicht imbegliefert) zum Multifunktionsgerät.

Mixer with planetary motion. Twin (twisting, rotational and orbital) movement.
Mechanism of metal gears.
35° swing arm for connection of different accessories.
18/10 stainless steel bowl with 5 L (69583) / 6 L (69683) capacity.
Transparent anti-splatter lid with opening for adding ingredients during use.
3 accessories for whisking, mixing and kneading.
Non-stick coating on the mixer and kneading accessories to prevent food from sticking.
Suction pads for good stability.
Non included accessories (jug and mincer) can be added to create a multifunctional kitchen robot.

Movimento de amassar planetário. Duplo movimento de rotação e orbital.
Mecanismo de engrenagens de metal.
Braço basculante de 35° para acoplar os diferentes acessórios.
Tigela de aço inoxidável 18/10 com capacidade para 5 L (69583) / 6 L (69683).
Tampa transparente, anti-salpicaduras, com janela para acrescentar ingredientes durante a utilização.
3 acessórios para bater, misturar e amassar.
Acessórios misturador e amassador com revestimento antiaderente, para evitar que os alimentos se agarrem.
Ventosas de sujeição para maior estabilidade.
Acessórios não incluídos (jarra e picadora) compatíveis para transformar a sua batedeira amassadeira num robô multifuncional.

New

Velocidades
6+PULSE
Speeds



Batidora amasadora COMPLET
Batteur pétrisseur
Mix- und Knetmaschine
Mixer-kneader
Batedeira amasadora

Ref	€	W	L	U.Venta
69683	344,75	1500	5,0	1

Ref	Tensión/Voltage	Potencia Power	Velocidades Speeds	Veloc. Amasadora Kneading speed	Velocidad jarra Jug speed	Veloc. picadora Mincer speed	Capacidad Capacity	Dimensiones/Sizes	Peso/Weight
69583	220-240 V, 50/60 Hz	1000 W	5	128 - 540 r.p.m.	3.200 - 13.500 r.p.m.	41 - 172 r.p.m.	5,0 L	32,5x25x36,5 cm	6,35Kg
69683	220-240 V, 50/60 Hz	1500 W	6	117 - 606 r.p.m.	2.600 - 13.500 r.p.m.	37 - 195 r.p.m.	6,0 L	40x25,5x33,5 cm	7,00 Kg

Tapa transparente
anti-salpicaduras extraíble
Removable non-spatter
transparent lid

5 velocidades y Turbo
5 speeds and Turbo

Inox



Con dos pasos consigue una
batidora de varillas
With two steps you get a whisk



2 in 1

Dos electrodomésticos en uno
Two appliances in one



Bate, mezcla y amasa.
Velocidad regulable, doble movimiento
de giro, rotativo y orbital.
Brazo basculante para acoplar los
distintos accesorios.

Batte, mélanger et pétrir.
Vitesse réglable, double mouvement de
rotation, rotatif et orbital.
Bras pivotant pour fixer aisément les
différents accessoires.

Beat, mix and knead.
Adjustable speed, double twisting, rota-
ting and orbital motion.
Swing arm for connection of different
accessories.



Household use

Incluye dos juegos de varillas
para batir y amasar
Includes two sets of bars to beat
and knead

Batidora amasadora MULTI

Batteur pétrisseur
Mix- und Knetmaschine
Mixer-kneader
Batedeira amasadora

Ref	€	W	L	U.Venta
69483	202,53	400	3,50	1

Ref	Tensión/Voltage	Potencia/Power	Velocidad/Speed	Velocidad/Speed	Capacidad/Cap.	Dimensiones/Sizes	Peso/Weight
69483	220-240 V; 50/60 Hz	400 W	5 + TURBO	1.200 r.p.m.	3,50 L	33,5x22x34 cm	2,45 Kg

Ideal para elaborar batidos y cócteles
Ideal for making smoothies and cocktails



Professional use

Batidora

Batteur
Mixer
Blender
Batedeira

Ref	€	U.Venta
69111	242,88	1

Ref	Tensión/Voltage	Potencia/Power	Velocidad/Speed	Capacidad/Capacity	Dimensiones/Sizes	Peso/Weight
69111	220-240 V / 50-60 Hz	400 W	10.000 - 15.000 r.p.m.	0,60 L	21x15x51 cm	6,20 Kg

BATIDORAS BRISK

Professional use



Fabricado en materiales altamente resistentes y de máxima calidad. El mango ergonómico ofrece mayor seguridad y control de la batidora. Indicado para trabajar en ollas de hasta 10 litros de capacidad. Los brazos trituradores, batidores y cuchillas, fabricados en acero inoxidable. Colocación y desmontaje sencillo e instantáneo, sin necesidad de utilizar herramientas. Prepara purés, cremas y todo tipo de salsas.

Fabriqu  avec des mat riaux hautement r sistants et d'une qualit  maximale. Le manche ergonomique offre une s curit  et un contr le accru du mixeur. Indiqu  pour travailler dans des marmites de jusqu'  10 litres de capacit . Accessoires pour hacher, mixer, couper, fabriqu s en acier inoxydable. Installation et d montage simple et instantan , sans utilisation d'outils suppl mentaires. Permet de pr parer des pur es, des cr mes et tout type de sauces.

Aus strapazierf higen und hochwertigen Materialien hergestellt. Ergonomischer Griff f r sicheren Halt und Handhabung des Mixers. Eignet sich zur Arbeit mit bis zu 10 Liter gro en T pfen. H cksler, P rierstab und Messer aus Edelstahl. Aufs tze lassen sich einfach und schnell ohne Einsatz von Werkzeugen einsetzen und entfernen. Zur Bereitung von P rees, Cremes und alle m glichen Saucen.

Made from highly resistant materials of the highest quality. The ergonomic handle provides greater safety and control of the blender. Suitable for working in pots up to 10 litres. The shredders, beaters and blades are made of stainless steel. Fitting and removing is simple and instant, without using tools. Prepare soups, pur es and all kinds of sauces.

Fabricada com materiais altamente resistentes e de m xima qualidade. O mango ergon mico oferece maior seguran a e controle da batidoira. Indicado para panelas de at  10 litros de capacidade. Bra o triturador, batedor e l minas de a o inoxid vel. Coloca o e desmontagem f cil e instant nea, sem necessidade de utilizar ferramentas. Prepara pur es, cremes e todo o tipo de molhos.

R pida - Eficiente - Robusta
Fast - Efficient - Robust



Regulador de velocidad variable
R gulateur de vitesse variable
Variable speed controller



Bot n de uso continuo
Bouton d'utilisation continue
Continuous use button



Brazo de f cil desmontaje en acero inoxidable
Braz en acier inoxydable facilement d montable.
Easy to remove arm made of stainless steel



Cuchilla de gran calidad para un  ptimo trabajo
Lame de grande qualit  pour un travail optimal
High-quality blade for optimum work

Serie 220

Batidora para uso discontinuo · Mixeur pour une utilisation discontinue · Mixer für diskontinuierliche Verwendung · Blender for discontinuous use
Batedeira para uso discontinuo

Velocidad Fija · Fixed Speed



Batidor Profesional Velocidad Fija
Mixer Professionnelle Vitesse Fixe
Profi-mixer, Festdrehzahl
Professional immersion blender fixed speed
Batedeira Profissional Velocidade Fixa

Ref	€	W	U.Venta
69722	198,79	220	1



Velocidad Variable · Variable Speed



Batidor Profesional Velocidad Variable
Mixer Professionnelle vitesse variable
Profi-mixer, variable Geschwindigkeit
Professional immersion blender variable speed
Batedeira Profissional Velocidade variável

Ref	€	W	U.Venta
69723	212,58	220	1



Ref	Tensión/Voltage	Potencia/Power	Velocidad/Speed	Capacidad/Capacity	L. Brazo/Arm length	Peso/Weight
69722	220-240 V, 50/60 Hz	220 W	20.000 r.p.m	10 L	16 cm	1,50 Kg
69723	220-240 V, 50/60 Hz	220 W	4.000 - 20.000 r.p.m	10 L	16 cm	1,50 Kg

Accesorios

Accessoires · Zubehör · Accessories · Acessórios

Brazo triturador

Pied mixeur
Rohr
Shaft tube
Pé triturador



Ref	€	L (cm)	U.Venta
69816	101,05	16	1

Brazo batidor

Fouet mélangeur
Rührbesen
Whisk
Pé amassadora



Ref	€	L (cm)	U.Venta
69815	141,31	18,5	1

Para serie 220 · For 220 series



Set llaves desmontaje cuchillas
Outil démontage lame set
Schlüsselsatz zum Wechseln der Messer
Blade disassembly tool set
Set ferrament desmontagem lâmina



Ref	€	U.Venta
R69722f	9,34	1

Incluye tacos y tornillos
para su instalación
Includes studs and screws
for installation



Inox
18/10

Soporte batidora BRISK

Support mélangeur
Standmixer
Blender stand
Suporte para batedeira

Ref	€	L (cm)	h (cm)	ØVarilla (mm)	U.Venta
A 69801	7,37	7	5,5	5,0	1 Individual
B 69803	13,90	28	5,5	5,0	1 Triple

Serie 350

Batidora para uso continuo - Mixeur pour une utilisation continue - Mixer für kontinuierlichen Gebrauch | Blender for continuous use
Batedeira para uso continuo

Velocidad Fija - Fixed Speed



Batidor Profesional Velocidad Fija

Mixer Professionnelle Vitesse Fixe
Profi-mixer, Festdrehzahl
Professional immersion blender fixed speed
Batedeira Profissional Velocidade Fixa

	Ref	€	Brazo (cm)	U. Venta
A	69761	255,12	20	1
B	69762	265,81	25	1
C	69763	276,39	30	1
D	69764	292,37	40	1
E	69765	313,53	50	1



Velocidad Variable - Variable Speed



Batidor Profesional Velocidad Variable

Mixer Professionnelle vitesse variable
Profi-mixer, variable Geschwindigkeit
Professional immersion blender variable speed
Batedeira Profissional Velocidade variável

	Ref	€	Brazo (cm)	U. Venta
A	69771	269,02	20	1
B	69772	279,61	25	1
C	69773	290,29	30	1
D	69774	306,06	40	1
E	69775	327,33	50	1



	Ref	Tensión/Voltage	Potencia/Power	Velocidad/Speed	Capacidad/Capacity	L. Brazo/Arm length	Composición/Comp	Peso/Weight
Velocidad Fija - Fixed Speed	69761	220-240 V / 50-60 Hz	350 W	16.000 r.p.m	15 L	20 cm	69735: Motor/Motor 69820: Brazo/Arm	2,95 Kg
	69762	220-240 V / 50-60 Hz	350 W	16.000 r.p.m	20 L	25 cm	69735: Motor/Motor 69825: Brazo/Arm	3,00 Kg
	69763	220-240 V / 50-60 Hz	350 W	16.000 r.p.m	30 L	30 cm	69735: Motor/Motor 69830: Brazo/Arm	3,80 Kg
	69764	220-240 V / 50-60 Hz	350 W	16.000 r.p.m	80 L	40 cm	69735: Motor/Motor 69840: Brazo/Arm	4,00 Kg
	69765	220-240 V / 50-60 Hz	350 W	16.000 r.p.m	120 L	50 cm	69735: Motor/Motor 69850: Brazo/Arm	4,20 Kg
Velocidad Variable - Variable Speed	69771	220-240 V / 50-60 Hz	350 W	4.000 - 16.000 r.p.m	15 L	20 cm	69736: Motor/Motor 69820: Brazo/Arm	2,95 Kg
	69772	220-240 V / 50-60 Hz	350 W	4.000 - 16.000 r.p.m	20 L	25 cm	69736: Motor/Motor 69825: Brazo/Arm	3,00 Kg
	69773	220-240 V / 50-60 Hz	350 W	4.000 - 16.000 r.p.m	30 L	30 cm	69738: Motor/Motor 69830: Brazo/Arm	3,80 Kg
	69774	220-240 V / 50-60 Hz	350 W	4.000 - 16.000 r.p.m	80 L	40 cm	69738: Motor/Motor 69840: Brazo/Arm	4,00 Kg
	69775	220-240 V / 50-60 Hz	350 W	4.000 - 16.000 r.p.m	120 L	50 cm	69738: Motor/Motor 69850: Brazo/Arm	4,20 Kg

Serie 500

Batidora para uso continuo e intensivo - Mixeur pour une utilisation continue et intensive - Mixer für kontinuierlichen und intensiven Gebrauch
Blender for continuous and intensive use - Batedeira para uso contínuo e intensivo

Velocidad Fija - Fixed Speed



Batidor Profesional Velocidad Fija

Mixer Professionnelle Vitesse Fixe
Profi-mixer, Festdrehzahl
Professional immersion blender fixed speed
Batedeira Profissional Velocidade Fixa

	Ref	€	Brazo (cm)	U. Venta
A	69781	269,65	20	1
B	69782	280,23	25	1
C	69783	290,92	30	1
D	69784	306,79	40	1
E	69785	327,95	50	1



Velocidad Variable - Variable Speed



Batidor Profesional Velocidad Variable

Mixer Professionnelle vitesse variable
Profi-mixer, variable Geschwindigkeit
Professional immersion blender variable speed
Batedeira Profissional Velocidade variável

	Ref	€	Brazo (cm)	U. Venta
A	69791	281,89	20	1
B	69792	292,47	25	1
C	69793	303,05	30	1
D	69794	318,93	40	1
E	69795	340,20	50	1



	Ref	Tensión/Voltage	Potencia/Power	Velocidad/Speed	Capacidad/Capacity	L. Brazo/Arm length	Composición/Comp.	Peso/Weight
Velocidad Fija - Fixed Speed	69781	220-240 V / 50-60 Hz	500 W	16.000 r.p.m	30 L	20 cm	69750: Motor/Motor 69820: Brazo/Arm	3,55 Kg
	69782	220-240 V / 50-60 Hz	500 W	16.000 r.p.m	40 L	25 cm	69750: Motor/Motor 69825: Brazo/Arm	3,60 Kg
	69783	220-240 V / 50-60 Hz	500 W	16.000 r.p.m	60 L	30 cm	69750: Motor/Motor 69830: Brazo/Arm	4,40 Kg
	69784	220-240 V / 50-60 Hz	500 W	16.000 r.p.m	100 L	40 cm	69750: Motor/Motor 69840: Brazo/Arm	4,60 Kg
	69785	220-240 V / 50-60 Hz	500 W	16.000 r.p.m	140 L	50 cm	69750: Motor/Motor 69850: Brazo/Arm	4,80 Kg
Velocidad Variable - Variable Speed	69791	220-240 V / 50-60 Hz	500 W	4.000 - 16.000 r.p.m	30 L	20 cm	69751: Motor/Motor 69820: Brazo/Arm	3,55 Kg
	69792	220-240 V / 50-60 Hz	500 W	4.000 - 16.000 r.p.m	40 L	25 cm	69751: Motor/Motor 69825: Brazo/Arm	3,60 Kg
	69793	220-240 V / 50-60 Hz	500 W	4.000 - 16.000 r.p.m	60 L	30 cm	69751: Motor/Motor 69830: Brazo/Arm	4,40 Kg
	69794	220-240 V / 50-60 Hz	500 W	4.000 - 16.000 r.p.m	100 L	40 cm	69751: Motor/Motor 69840: Brazo/Arm	4,60 Kg
	69795	220-240 V / 50-60 Hz	500 W	4.000 - 16.000 r.p.m	140 L	50 cm	69751: Motor/Motor 69850: Brazo/Arm	4,80 Kg

Accesorios

Accessoires · Zubehör · Accessories · Acessórios

Serie 350



Motor batidor Profesional SÉRIE 350

Moteur mixer Professionnelle SÉRIE 350

Professioneller Mixer Motor, SÉRIE 350

Professional immersion blender motor, SÉRIE 350

Motor bateadeira Profissional SÉRIE 350

	Ref	€	W	U.Venta	
A	69735	143,80	350	1	Velocidad Fija · Fixed Speed
B	69736	157,49	350	1	Velocidad Variable · Variable Speed

Serie 500



Motor batidor Profesional SÉRIE 500

Moteur mixer Professionnelle SÉRIE 500

Professioneller Mixer Motor, SÉRIE 500

Professional immersion blender motor SÉRIE 500

Motor bateadeira Profissional SÉRIE 500

	Ref	€	W	U.Venta	
A	69750	158,12	500	1	Velocidad Fija · Fixed Speed
B	69751	170,36	500	1	Velocidad Variable · Variable Speed

Braço triturador

Pied mixeur

Rohr

Shaft tube

Pé triturador

	Ref	€	L (cm)	A (cm)	U.Venta
A	69820	111,53	20	12,5	1
B	69825	122,11	25	15,8	1
C	69830	132,70	30	19,2	1
D	69840	148,57	40	25,8	1
E	69850	169,84	50	32,5	1
F	69824	153,97	25	-	1



Para serie 350 / 500 For 350/500 series



Incluye tacos y tornillos para su instalación
Includes studs and screws for installation



Inox 18/10

Soporte batidora BRISK

Support mélangeur

Aufhängeleiste für Mixer

Blender stand

Suporte para bateadeira

Set llaves desmontaje cuchillas

Outil démontage lame set

Schüsselsatz zum Wechseln der Messer

Blade disassembly tool set

Set ferrament desmontagem lâmina

Ref	€	U.Venta
R69735F	9,23	1



	Ref	€	L (cm)	h (cm)	ØVarilla (mm)	U.Venta
A	69801	7,37	7	5,5	5,0	1 Individual
B	69803	13,90	28	5,5	5,0	1 Triple

BATIDOR BAMIX

Professional use



bamix



Accesorios

Accessoires · Zubehör · Accessories · Acessórios

Grupo pulverizador

Broyeur
Mahlinheit
Pulverizing unit
Conjunto pulverizador



Ref	€	ml	U.Venta
61674	40,67	250	1



Batidora BAMIX

Mixer
Mixer
Mixer
Batedeira

Ref	€	cuchillas	U.Venta
61672	284,28	4	1
61673	443,95	4	1

Grupo cortador 5 cuchillas

Combiné râpeur
Schneide-/Zubereitungseinheit
Cutting/preparing unit
Conjunto cortador 5 láminas



Ref	€	ml	U.Venta
61675	167,04	500	1

Ref	Tensión/Voltage	Potencia/Power	Velocidad/Speed	Inmersión/Inmersion	Altura/Height
61672	220-240 V / 50-60 Hz	200 W	14.000 - 18.000 r.p.m.	25 cm	39,5 cm
61673	220-240 V / 50-60 Hz	350 W	18.000 - 22.000 r.p.m.	35 cm	49,5 cm

BATIDORA PRO

Household use



Resultados más finos y uniformes

Finer and more even blending



Regulador de velocidad
Speed regulator



TURBO
Máxima potencia
Maximum power



Fácil montaje / desmontaje
Easy assembly / disassembly



Cuchillas afiladas
Sharp blades



Antisalpicaduras
Anti-splash housing



Mango ergonómico
Ergonomic handle



Batidora PRO

Mixer
Mixer
Mixer
Batedeira

Ref	€	W	U.Venta
A 61682	59,09	1000	1
B 61683	66,09	1000	1

Picadora incluida Mincer included

Ref	Tensión/Voltage	Potencia/Power	Velocidad/Speed	Vaso/Glass	Picadora/Mincer	Dimensiones/Sizes	Peso/Weight
61682	220-240 V, 50/60 Hz	1000 W	13.050 - 15.950 r.p.m.	800 ml (28 oz)	-	Ø6,3 x 41,2 cm	0,805 Kg
61683	220-240 V, 50/60 Hz	1000 W	13.050 - 15.950 r.p.m.	800 ml (28 oz)	500 ml	Ø6,3 x 41,2 cm	1,200 Kg



FUNCIÓN SELF-SPEED. Permite regular la velocidad de giro de la cuchilla. 4 cuchillas de acero inoxidable de gran durabilidad: dos rectas y dos curvas para un óptimo rendimiento.

Pie batidor de 21 cm de longitud y fabricado en acero inoxidable 18/10. El sistema de anclaje tipo rosca disminuye las vibraciones durante el uso. Incluye vaso mezclador con base antideslizante de 800ml, marcado en ml/cups y libre de BPA.

Accesorios aptos para el lavavajillas.

FONCTION SELF-SPEED: Permet de régler la vitesse de rotation de la lame. 4 lames en acier inoxydable d'une grande durabilité: deux droites et deux courbées pour un rendement optimal.

Pied mixeur de 21 cm de longueur fabriqué en acier inoxydable 18/10. Le système d'ancrage de type fileté réduit les vibrations pendant l'utilisation. Inclut un verre mélangeur avec une base antidérapante de 800 ml, avec des marques en ml/cups et sans bisphénol A.

Accessoires aptes pour le lave-vaisselle.

SELF-SPEED-FUNKTION: Ermöglicht das Drehmoment der Klinge zu regulieren. 4 Edelstahlklingen: zwei gerade und zwei gekrümmte Klingen sorgen für optimale Ergebnisse.

Länge des Mix-Sockels: 21 cm. Material: Edelstahl 18/10. Die Schraubfestigung verringert Vibrationen während des Betriebs. 800 ml Mixbehälter mit rutschfester Basis und Füllstandsanzeigen in ml/Tassen. BPA-frei. Waschmaschinen taugliches Zubehör.

SELF-SPEED FUNCTION: Enables you to control the speed at which the blade rotates. 4 highly durable stainless steel blades: two straight and two curved for optimum performance.

21cm blending arm made of 18/10 stainless steel. The screw-type attachment system reduces vibrations during use. Includes 800ml BPA-free mixing beaker with anti-slip base and fill-level indicators in ml/cups. Dishwasher-safe accessories.

FUNÇÃO "SELF-SPEED" Permite regular a velocidade de rotação da lâmina. 4 lâminas de aço inoxidável, de grande resistência. Duas lâminas retas e duas curvas, para um ótimo rendimento.

Base de bateleira com 21 cm de comprimento, fabricada em aço inoxidável 18/10. O sistema de fixação de tipo rosca reduz as vibrações durante a sua utilização. Inclui vaso misturador com base antideslizante de 800 ml, com escala de ml/cups e livre de BPA.

Accesórios aptos para a máquina de lavar louça.

Accesorios

Accessoires · Zubehör · Accessories · Acessórios

Picadora

Hachoir
Fleischwolf
Mincer
Picadora

Ref	€	ml	U.Venta
R61682A	10,79	500	1

Incluida en la Ref.: 61683. Included in Ref.: 61683.



Batidor varillas

Fouet multibrins
Schneebehrer
Wire whisk
Batedeira varetas

Ref	€	L (cm)	U.Venta
R61682B	6,33	20	1



BATIDORA MIX

Household use



Resultados más finos y uniformes

Finer and more even blending



Regulador de velocidad
Speed regulator



TURBO
Máxima potencia
Maximum power



Fácil montaje/desmontaje
Easy assembly / disassembly



Cuchillas afiladas
Sharp blades



Antisalpicaduras
Anti-splash housing



SOFT TOUCH
Mango ergonómico
Ergonomic handle



Dispone de una ruleta de fácil manejo para ajustar la velocidad y obtener la textura deseada.
4 cuchillas de acero inoxidable de gran durabilidad: dos rectas y dos curvas para un óptimo rendimiento. Sistema anti-salpicaduras.
Pie batidor de 21cm de acero inoxidable desmontable de fácil colocación que facilita su almacenamiento y limpieza.
Incluye un recipiente mezclador de 800 ml (marcado en ml /oz), libre de BPA. Vaso apto para el lavavajillas.

Disposé d'une roulette facile à utiliser pour ajuster la vitesse et obtenir la texture souhaitée.
4 lames en acier inoxydable d'une grande durabilité: deux droites et deux courbes pour un rendement optimal. Système anti-éclaboussures.
Piec mixeur de 21 cm en acier inoxydable démontable facile à installer qui facilite le rangement et le nettoyage.
Inclut un récipient pour mélanger de 800 ml (avec marques en ml /oz), sans bisphénol A.
Bot apte pour le lave-vaisselle.

Benutzerfreundlicher Drehregler zum Einstellen der Drehzahl und zum Erhalt der gewünschten Konsistenz.
Zwei gerade und zwei gekrümmte Edelstahlklingen sorgen für optimale Ergebnisse.
21 cm großer Mixstab aus Edelstahl lässt sich leicht anbringen und wieder anbringen und ist daher leicht zu reinigen und zu verstauen.
Inkl. 800 ml großer Mixbehälter (Markierung in ml /oz), ohne BPA.
Gefäß ist spülmaschinengeeignet.

It has an easy-to-use wheel to adjust the speed and obtain the desired texture.
4 highly durable stainless steel blades: two straight and two curved for optimum performance.
Anti-splash system.
The 21cm stainless steel blender stick is easy to attach and removable for easy storage and cleaning.
Includes an 800ml BPA-free mixing bowl (marked in ml/oz).
The glass is dishwasher safe.

Dispõe uma roleta fácil de utilizar, para ajustar a velocidade e conseguir a textura desejada.
4 lâminas de aço inoxidável - duas retas e duas curvas para um rendimento ótimo - de grande durabilidade. Sistema anti-salpicaduras.
Acessório batedor de 21 cm, em aço inoxidável, desmontável e de fácil colocação, para facilitar a sua armazenagem e limpeza.
Inclui um recipiente misturador de 800 ml (ml/oz), livre de BPA.
Copo apto para a máquina de lavar louça.

Accesorios

Accessoires · Zubehör · Accessories · Acessórios



Batidora MIX
Mixer
Mixer
Mixer
Batedeira



Picadora
Hachoir
Fleischwolf
Mincer
Picadora

Ref	€	ml	U.Venta
R61679A	10,58	800	1



Batidor varillas
Fouet multibrins
Schneebesen
Wire whisk
Batedeira varetas

Ref	€	L (cm)	U.Venta
000,00	5,50	23	1

Ref	€	W	U.Venta
61679	52,91	700	1

Ref	Tensión/Voltage	Potencia/Power	Velocidad/Speed	Cap. contenedor/Container cap.	Dimensiones/Sizes	Peso/Weight
61679	220-240 V, 50/60 Hz	700 W	13.000 - 15.300 r.p.m.	800 ml (28 oz)	06,5 x 41 cm	0,930 Kg

BATIDORAS LACOR

- Household use -



Cuchillas exclusivas de alto rendimiento
Exclusive high performance blades

Batidora LACOR

Mixeur
Mixer
Blender
Batedeira

Ref	€	W	U.Venta
61681	65,05	700	1



Permite montar, batir, mezclar, triturar y picar todo tipo de frutas y verduras, así como picar hielo.

Prepara salsas, batidos, papillas y cremas gracias a sus 4 cuchillas intercambiables (incluye llave para cambiar las cuchillas).

2 velocidades: SLOW/TURBO. Profundidad del brazo: 23 cm.

Incluye un recipiente mezclador de 500 ml, libre de BPA.

Permet de monter, battre, mélanger, triturer et émincer tout type de fruits et légumes, ainsi que de piler la glace.

Prépare des sauces, des smoothies, des bouillies et des crèmes grâce à ses 4 lames interchangeables (inclut une clé pour changer les lames).

2 vitesses: SLOW/TURBO. Profondeur du bras: 23 cm.

Inclut un récipient pour mélanger de 500 ml, sans BPA.

Zum Schlagen, Mischen, Zerkleinern und Zerkhacken von Obst und Gemüse aller Art und auch zum Zerkhacken von Eis.

Zum Bereiten von Saucen, Shakes, Babybrei und Cremes, mit 4 austauschbaren Schneidauisätzen (Schlüssel zum Wechseln imbegriffen).

2 Geschwindigkeitsstufen: Slow/Turbo. Länge Mixstab: 23 cm.

Inkl. 500 ml großem Mixbehälter, ohne BPA.

It enables assembly, beating, mixing, crushing, and chopping of all type of fruits, vegetables, and ice.

Prepares sauces, smoothies, mashes, and creams with its 4 interchangeable blades (includes wrench to change blades).

2 speeds: SLOW/TURBO. Arm Depth: 23 cm.

Includes a mixing container of 500 ml, BPA free.

Permite montar, bater, misturar, triturar e picar todo o tipo de frutas e verduras, bem como picar gelo.

Para preparar molhos, batidos, papas e cremas, graças às suas 4 lâminas intercambiáveis (inclui chave para substituir as lâminas).

2 velocidades: SLOW/TURBO. Profundidade do braço: 23 cm.

Inclui um recipiente misturador de 500 ml, sem BPA.

Accesorios

Accessoires - Zubehör - Accessories - Acessórios



Cuchillas exclusivas de alto rendimiento
Exclusive high performance blades

Batidora Picadora LACOR

Mixeur hacheur
Mixer und Fleischwolf
Blender chopper
Batedeira picadora

Ref	€	W	U.Venta
61671	74,39	700	1

Picadora

Hachoir
Fleischwolf
Mincer
Picadora

Ref	€	ml	U.Venta
R61671A	10,69	750	1

Incluida en la Ref.: 61671 - Incluída in Ref.: 61671



Soporte pared

Support mural
Wandhalterung
Wall support
Suporte de parede

Ref	€	U.Venta
R61671F	0,93	1



Ref	Tensión/Voltage	Potencia/Power	Velocidad/Speed	Capacidad/Capacity	Velocidad/Speed	L.brazo/Shaft long	Peso/Weight
61681	220-240 V; 50/60 Hz	700 W	9.000 - 16.000 r.p.m.	500 ml (blender)	SLOW / TURBO	23 cm	1,10 Kg
61671	220-240 V; 50/60 Hz	700 W	9.000 - 16.000 r.p.m.	750 ml (mincer) / 500 ml (blender)	SLOW / TURBO	23 cm	1,45 Kg

PICADORA DE CRISTAL

New



Gran potencia y capacidad

Great power and capacity



Picadora de cristal

Hachoir en verre
Fließschwiff, glas
Glass mincer
Picadora de vidro

Ref	€	W	L	U.Venta
69073	59.97	300	20	1

Ref	Tensión/Voltage	Potencia/Power	Nºcuchillas/Blades	Øcuchillas/Blades	Capacidad/Cap.	Dimensiones/Sizes	Peso/Weight
69073	220-240 V ; 50/60 Hz	300 W	4	12 cm	2.0 L	21x17,5x27 cm	2,10 Kg



Picadora eléctrica compacta que pica todo tipo de alimentos, como verduras, frutas, jengibre, ajo, cebolla, frutos secos y hierbas.

Cabezal de acero inoxidable y recipiente de cristal de alta calidad.

Cuchillas ultra-resistentes.

Gracias a los engranajes metálicos permite un uso continuo.

Corta con precisión y homogéneamente.

2 velocidades; la más veloz para un corte rápido y la más lenta para un corte más controlado.

Base antideslizante para facilitar la tarea y evitar desplazamientos.

Fácil de desmontar y limpiar. Contenedor y cuchillas aptos para el lavavajillas.

Hachoir électrique compacte qui hache/émince tout type d'aliments tels que les légumes, les fruits, le gingembre, l'ail, l'oignon, les fruits secs et les herbes.

Tête en acier inoxydable et récipient en verre de grande qualité.

Lames ultrarésistantes en acier inoxydable.

Utilisation continue prolongée grâce à ses engranages métalliques.

Coupe avec précision et de façon homogène.

2 vitesses : la plus rapide pour une coupe rapide et la plus lente pour une coupe plus contrôlée.

Base antidérapante pour faciliter la tâche et éviter tout déplacement.

Facile à démonter et à nettoyer. Conteneur et lames aptes pour le lave-vaisselle.

Kompakter Multizerkleinerer zum Zerkleinern von Gemüse, Obst, Ingwer, Knoblauch, Zwiebeln, Dörrobst und Kräutern.

Edestahlkopf und hochwertige Glasschale.

Scharfe, äußerst widerstandsfähigen Klingen.

Dauerinsatz durch Metallzahnrad möglich.

Schneidet präzise und gleichmäßig.

2 Schnittstufen: einmal schnell und einmal langsamer und kontrolliert.

Müheslos und sicheres Arbeiten dank rutschfester Standfläche.

Teile einfach abnehmbar und zu reinigen. Behälter und Klingen sind spülmaschinengeeignet.

Compact electric mincer that processes all kinds of food, such as vegetables,

fruit, ginger, garlic, onions, dried fruit and herbs.

Stainless steel head and high-quality glass container.

High-strength blades.

Its metal gears mean it can withstand longer continuous use.

High precision, even cutting.

2 speeds: fast for rapid cutting and slow for more controlled cutting.

Non-slip base for easier use with no movement.

Easy to disassemble for cleaning. Dishwasher-proof container and blades.

Picadora eléctrica compacta, para picar todo o tipo de alimentos, como verduras, frutas, gengibre, alho, cebola, frutos secos e ervas aromáticas.

Cabeça em aço inoxidável e recipiente de vidro de alta qualidade.

Lâminas ultra-resistentes.

As suas engrenagens metálicas permitem uma utilização contínua prolongada.

Corte homogéneo e de granos precisão.

2 velocidades: rápida para um corte mais rápido, e lenta para um corte mais controlado.

Base antiderrapante para facilitar o trabalho.

Fácil de desmontar e limpar. Recipiente e lâminas aptos para máquinas de lavar louça.



PICADORAS DE CARNE



Picadoras estables y resistentes.
Engranajes interiores y exteriores metálicos para una mayor resistencia.
Incluyen 3 discos perforados de acero inoxidable.
Incluyen 4 accesorios extra (Kibbe incluido).
Totalmente desmontables para facilitar su limpieza.

Machine stable et résistante.
Engrenages intérieurs et extérieurs métalliques pour une plus grande résistance.
Inclut 3 disques perforés en acier inoxydable.
Inclut 4 accessoires supplémentaires (kibbeh inclus).
Totalement démontable pour faciliter son nettoyage.

Stabile und beanspruchbare Klinge.
Innere und äußere Metallgetriebe für eine höhere Widerstandsfähigkeit.
3 perforierte Edelstahlcheiben.
Dazu gehören 4 Zubehörteile (inkl. Kibbeh).
Für eine einfache Reinigung, komplett auseinandernehmbar.

Stable and resistant choppers.
Interior and exterior metal gear teeth for improved resistance.
Includes 3 stainless steel perforated discs.
Includes 4 extra accessories (Kibbeh included).
Can be fully disassembled for easy cleaning.

Máquinas de picar carne estables e resistentes.
Engranagens interiores e exteriores metálicas para uma maior resistência.
Inclui 3 discos perfurados de aço inoxidável.
Inclui 4 acessórios extras (Kibbe inclusivo).
Totalmente desmontável para facilitar a sua limpeza.

Obtenga un tamaño de carne homogéneo

Get a size of homogeneous flesh

Accesorios

Accessoires · Accessories



Productividad
2 kg/min
 Productivity



AL **FU** **Inox**
 Aluminium **Porcelana** **Stainless Steel**

Professional use

Picadora de carne PRO

Machoir pour viande
 Fleischwolf
 Meal mincer
 Picadora de carne

Ref	€	W	U.Venta
69368	512.94	550	1

Ref	Tensión/Voltage	Potencia/Power	Par motor/Motor torque	Velocidad/Speed	Capacidad/Capacity	Dimensiones/Sizes	Peso/Weight
69368	220-240 V; 50 Hz	550 W	1,27 Nm	240 r.p.m	2 Kg/min	53,5x26x35 cm	11,0 Kg

Accesorios

Accessoires · Accessories



Productividad
1 kg/min
Productivity



Accesorios

Accessoires · Accessories



Productividad
1 kg/min
Productivity



AL **FU** **Inox**
Aluminium Fundido Cast Steel/Inox

Semiprofessional use

Picadora de carne
Hachoir pour viande
Fleischwolf
Meat mincer
Picadora de carne

Ref	€	W	U.Venta
69068	201,28	800	1

AL **FU**
Aluminium Fundido Cast

Semiprofessional use

Picadora de carne CHOP
Hachoir pour viande
Fleischwolf
Meat mincer
Picadora de carne

Ref	€	W	U.Venta
69369	100,95	300	1

Ref	Tensión/Voltage	Potencia/Power	Par motor/Motor torque	Capacidad/Capacity	Dimensiones/Sizes	Peso/Weight
69068	220-240 V; 50 Hz	800 W	0,25 Nm	1 Kg/min	35x18x36 cm	5,09 Kg
69369	220-240 V; 50/60 Hz	300 W	0,14 Nm	1 Kg/min	38,6x16,6x34,2 cm	3,70 Kg

CORTADORAS

New

2 entradas para los diferentes tipos de verduras
2 openings for different types of vegetables



Cortador de verduras para uso profesional

Construida totalmente en aluminio anodizado de alta resistencia

Cuerpo superior abatible para facilitar la limpieza, el mantenimiento y la colocación de los discos de corte

2 entradas para los diferentes tipos de verduras; entrada semicircular con palanca para alimentos voluminosos (patatas, tomates, cebollas, etc.) y entrada redonda con empujador para verduras y hortalizas más pequeñas (pepinos, calabacín, zanahorias, etc.)

Incluye 5 cuchillas; dos discos de corte (2 y 4 mm) y tres discos para rallar (3, 5 y 7 mm)

Funcionamiento continuo. Transmisión por correa.

2 sistemas de seguridad; tornillo de bloqueo de tapa y un sensor electromagnético (al abrir la tapa se apaga la máquina)

4 patas de goma para una mejor estabilidad

Coupe-légumes à usage professionnel

Entièrement fabriqué en aluminium anodisé d'une grande résistance

Corps supérieur rabattable pour faciliter le nettoyage, l'entretien et l'installation des disques de coupe

2 entrées pour les différents types de légumes : entrée semi circulaire avec levier pour aliments volumineux (pommes de terre, tomates, oignons, etc.) et entrée ronde avec poussoir pour légumes classiques et plus petits (courgettes, carottes, etc.)

Inclut 5 lames : deux disques pour couper (2 et 4 mm) et trois disques pour râper (3, 5 et 7 mm)

Funcionamiento continuo. Transmisión por correa

2 sistemas de seguridad : una vis de bloqueo del couvercle y un captador electro magnético (el aparato se apaga al abrir el couvercle)

4 pieds en caoutchouc pour une meilleure stabilité

Professioneller Gemüseschneider

Konstruktion aus 100 % hochfestem eloxiertem Aluminium

Klappbares Oberteil für einfache Reinigung, Pflege und Einsatz der Schneidescheiben

2 Öffnungen für unterschiedliche Gemüsearten: halbkreisförmige Öffnung mit Hebel für größere Stücke (Kartoffeln, Tomaten, Zwiebeln usw.) und runde Öffnung mit Stößel für kleinere Stücke (Gurken, Zucchini, Möhren usw.)

Beinhaltet 5 Schneider: zwei Schneidescheibe (2 und 4 mm) und drei Reibescheiben (3,5 und 7 mm)

Kontinuierlicher Betrieb. Riemenantrieb

2 Schutzsysteme: Fixierschraube für den Deckel und ein elektromagnetischer Sensor (beim Öffnen des Deckels schaltet sich das Gerät ab)

4 Gummifüße für festeren Stand

Vegetable slicer for professional use

Manufactured entirely in high strength anodized aluminium

Removable upper body for easy cleaning, maintenance, and placement of slicing discs

2 openings for different types of vegetables: semicircular opening with lever for larger foods (potatoes, tomatoes, onions, etc.) and round opening with pusher for smaller vegetables (cucumbers, zucchini, carrots, etc.)

Includes 5 blades: two slicing discs (2 and 4 mm) and three grating discs (3, 5 and 7 mm)

Continuous operation Belt drive

2 safety systems: cover locking screw and an electromagnetic sensor (when the cover is opened the machine turns off)

4 rubber bases for improved stability

Cortador de verduras para uso profesional

Fabricado totalmente em alumínio anodizado de alta resistência

Corpo superior rebatível, para facilitar a limpeza, a manutenção e a colocação dos discos de corte

2 entradas para os diferentes tipos de verduras: uma entrada semicircular com alavanca para alimentos voluminosos (batatas, tomates, cebolas, etc.) e uma entrada redonda com empurrador para verduras e hortaliças mais pequenas (pepinos, courgetes, cenouras, etc.)

Inclui 5 lâminas; dois discos de corte (2 e 4 mm) e três discos para ralar (3, 5 e 7 mm)

Funcionamento contínuo. Transmissão por correa.

2 sistemas de segurança; parafuso de bloqueio da tampa e um sensor eletromagnético (ao abrir a tampa a máquina desliga-se)

4 patas de borracha para maior estabilidade

Producción
100-300kg/h
Production



Cortadora de vegetales PROFESIONAL

Coupe-légumes PROFESSIONNEL

PROFESSIONELLER Gemüseschneider

PROFESSIONAL vegetable slicer

Cortadora de verduras PROFISSIONAL

Ref	€	W	U.Venta
69500	1.192,61	550	1

Ref	Tensión/Voltage	Potencia/Power	Nºdiscos/Discs	Veloc. discos Discs speed	Orif. redondo Round hole size	Orif. semicircular Semicircular hole	Dimensiones/Sizes	Peso/Weight
69500	220-240 V ; 50 Hz	550 W	5	270 r.p.m.	Ø 6 cm	17x7,5 cm	57x23x51 cm	22,5 Kg

Accesorios

Accessoires - Zubehör - Accessories - Acessórios

Disco rallador 3 mm

Disque à râper 3 mm
3 mm Reibe Scheibe
3 mm grater disc
Disco de ralador de 3 mm



Ref	€	mm	U.Venta
69503	39,74	3	1

Disco rallador 5 mm

Disque à râper 5 mm
5 mm Reibe Scheibe
5 mm grater disc
Disco de ralador de 5 mm



Ref	€	mm	U.Venta
69505	39,74	5	1

Disco rallador 7 mm

Disque à râper 7 mm
7 mm Reibe Scheibe
7 mm grater disc
Disco de ralador de 7 mm



Ref	€	mm	U.Venta
69507	39,74	7	1

Disco cortador 2 mm

Disque de coupe 2 mm
2 mm Schneidscheibe
2 mm cutter disc
Disco de corte de 2 mm



Ref	€	mm	U.Venta
69512	39,74	2	1

Disco cortador 4 mm

Disque de coupe 4 mm
4 mm Schneidscheibe
4 mm cutter disc
Disco de corte de 4 mm



Ref	€	mm	U.Venta
69514	39,74	4	1

Discos opcionales (NO incluidos)

Disques en option (NON inclus) · Optionale Discs (NICHT im Lieferumfang enthalten) · Optional discs (NOT included) · Discos opcionais (NÃO incluídos)

Disco cortador 8 mm

Disque de coupe 8 mm
8 mm Schneidscheibe
8 mm cutter disc
Disco de corte de 8 mm



Ref	€	mm	U.Venta
69518	79,37	8	1

Disco cortador 10 mm

Disque de coupe 10 mm
10 mm Schneidscheibe
10 mm cutter disc
Disco de corte de 10 mm



Ref	€	mm	U.Venta
69510	79,37	10	1



DC Professional use

Cortadora de fiambre

Trancheuse de charcuterie
Aufschnittmaschine
Cold meat cutter
Cortadora de fiambre

Ref	€	U.Venta
69125	568,03	1
69130	970,37	1

Estructura de aluminio
Aluminium frame



AC Household use

Cortadora de fiambre HOME

Trancheuse de charcuterie
Aufschnittmaschine
Cold meat cutter
Cortadora de fiambre

Ref	€	U.Venta
69118	101,57	1



Ref	Tensión/Voltage	Potencia/Power	Cuchilla/Blade	Esp. corte/Slice thick.	Dimensiones/Sizes	Peso/Weight
69125	220-240 V; 50/60 Hz	150 W	Ø250 mm / 10"	0 - 11 mm	48x39x36 cm	15,0 Kg
69130	220-240 V; 50/60 Hz	250 W	Ø300 mm / 12"	0 - 13 mm	60x58x44 cm	24,3 Kg
69118	220-240 V; 50/60 Hz	150 W	Ø190 mm / 7,5"	0 - 15 mm	37,3x27,9x27,5 cm	4,51 Kg

Incluye un destornillador para desmontar la cuchilla y una práctica piedra afiladora
Screwdriver for removing the blade and a practical sharpening stone included



Regulador del grosor de corte
(Ajustable de 0 a 8 mm)
Adjustable slicing thickness
(from 0 to 8 mm)



Potente, silencioso e higiénico
Corta sin esfuerzo y con una gran precisión
Powerful, quiet and clean
Effortless and high precision cutting

Incluye dos cuchillas
LISA y DENTADA
Includes two blades
SMOOTH and SERRATED



DC Professional use

Cortador de Kebab

Couteau à Kebab
Kebab-Schneider
Kebab cutter
Cortador de Kebab

Ref	€	W	U.Venta
69230	167,56	80	1

Ref	Tensión/Voltage	Potencia/Power	Velocidad/Speed	Cuchilla/Blade	Esp. corte/Thickness	Dimensiones/Sizes	Peso/Weight
69230	220-240 V; 50/60 Hz	80 W	2.800 r.p.m.	Ø100 mm	0 - 8 mm	19,9x11,4x18,4 cm	1,20 Kg



5 cortes con 5 colores para tus vegetales, frutas, quesos, nueces y chocolate

5 coupes avec 5 couleurs pour vos légumes, fruits, fromages, noix et chocolat
 5 Schneiden mit 5 Farben für ihr Gemüse, Obst, Käse, Nüsse und Schokolade
 5 cuts and 5 colours for your vegetables, fruit, cheeses, walnuts and chocolate
 5 cortes com 5 cores para os seus vegetais, frutas, queijos, nozes e chocolate



Household use

Corta vegetales
 Hachoir légumes
 Gemüseschneider
 Vegetables cutter
 Corta vegetales

5 cuchillas de colores
 5 colored blades



Ref € U.Venta
 69115 65,36 1

Ref	Tensión/Voltage	Potencia/Power	Cuchillas/Blades	Dimensiones/Sizes	Peso/Weight
69115	220-240 V; 50/60 Hz	150 W	5	24,5x22,5x19,5 cm	1,89 Kg



Jarra batidora
 Blender jug



Conj. batidor / montador
 Blending / whipping unit



Molinillo + Tapa
 Grinder + Lid



Discos corte
 Cutting disc



Conj. exprimidor
 Juicer attachment



Cortador mini
 Mini cutter



Conj. licuadora
 Smoothie unit



Corte con cuchilla
 Cutting with blades

Disfruta de una experiencia única
 en la cocina
 Enjoy a unique experience in the
 kitchen

8 funciones en 1
 8 functions in 1



Household use

Robot Multifunción
 Robot Multifonctions
 Multifunktions-Roboter
 Multifunction Robot
 Robô Multifuncionalis



Ref € U.Venta
 69079 158,53 1

Ref	Tensión/Voltage	Potencia/Power	Velocidades/Speeds	Capacidad/Capacity	Dimensiones/Sizes	Peso/Weight
69079	220-240 V; 50 Hz	800 W	10	1,50 L	24x22x40 cm	6,50 Kg

▶ DESHIDRATADORES



Una forma natural y sencilla de conservar frutas, verduras, setas, carnes, pescados, etc. con todos sus nutrientes durante más tiempo.

Extrae el agua, impidiendo su descomposición por microorganismos, conservándolos sin perder sus valores.

Calentamiento, el aire circula por su interior de manera uniforme, penetrando por los orificios de las bandejas.

Accesorio adicional para deshidratar salsas y realizar galletas.

Une façon naturelle et simple de conserver les fruits, les légumes, les champignons, les viandes, les poissons, etc. en gardant tous leurs nutriments pendant plus longtemps.

Extrait l'eau, empêchant ainsi leur décomposition due à des microorganismes, en les conservant sans perdre leurs valeurs.

Chauffe, l'air circule uniformément, en pénétrant par les orifices des plateaux.

Accessoire supplémentaire pour déshydrater des sauces et réaliser des biscuits.

Obst, Gemüse, Pilze, Fisch, Fleisch usw. kann so auf einfache und natürliche Weise haltbar gemacht werden. Nahrungsmittel.

Temperatur kann bis auf 70°C geregelt werden.

Rundum-Beheizung: Gleichmäßige Hitzeverteilung durch selbstrotierende Aufsätze mit luftdurchlässigen Böden.

Zubehör zur Trocknung von Saucen und Bereitung von Keksen.

A natural and easy way to preserve fruits, vegetables, mushrooms, meats, fish, etc. with all their nutrients for more time.

Extracts water from foods, preventing spoilage due to microorganisms and preserving them without losing their values.

Heating, the air circulates evenly through its interior, penetrating through the holes in the trays.

Additional accessory for dehydrating sauces and making biscuits.

Uma forma simples e natural de conservar frutas, verduras, cogumelos, carnes, peixes, etc., com todos os nutrientes durante mais tempo.

Extra a água dos alimentos, impedindo assim a sua decomposição devido aos microorganismos, e conservando-os sem que percam as suas qualidades.

Aquecimento, o ar circula no seu interior de maneira uniforme, penetrando nos orifícios das bandejas.

Accessório adicional para desidratar molhos e elaborar bolachas.



Tiempo recomendado
35 h
Recommended time

Professional use

6 bandejas desmontables
6 removable trays

Deshidratador de alimentos PRO

Dehydrateur des aliments

Obsttrockner, elektrisch

Food dehydrator

Desidratador de alimentos

Ref	€	W	U.Venta
69523	169,11	800	1



Láminas antiadherentes

Feuilles antiadhésif

Antihalt-Blätter

Non-stick sheets

Lâminas antiaderentes

Ref	€	cm	Unidades	U.Venta
66746	8,09	30x40	3	1

Soporta hasta 250°C
Supports up to 250°C



Reutilizables, para su conservación se recomienda su lavado a mano.
Vida útil aproximadamente de 1000 hornados.

Recortable.

Reusable, for its good condition, we recommend washing by hand.
Can be used approximately 1,000 times.

Can be cut.

Ref	Tensión/Voltage	Potencia/Power	Temperatura/Temp.	Capacidad/Capacity	Dimensiones/Sizes	Peso/Weight
69523	220-240 V, 50/60 Hz	800 W	29°C - 73°C (max)	6 bandejas / Trays	36x47x26 cm	5,50 Kg

Incluye **RECETARIO**
RECIPE BOOK Included

5 bandejas desmontables
5 removable trays



Tempo recomendado
48 h (max)
Recommended time



Semiprofessional use

Deshidratador giratorio TERRA

Déshydrateur tournant
Drehdehydrator
Rotating dehydrator
Desidratador giratório

Sistema de giro 360° automático
360° automatic rotation system

Ref	€	W	U.Venta
69223	107,38	500	1

5 bandejas desmontables
5 removable trays



Tempo recomendado
35 h (max)
Recommended time



Household use

Deshidratador de alimentos

Déshydrateur des aliments
Obstrockner, elektrisch
Food dehydrator
Desidratador de alimentos

Ref	€	W	U.Venta
69123	63,29	250	1

Ref	Tensión/Voltage	Potencia/Power	Temperatura/Temp.	Capacidad/Capacity	Dimensiones/Sizes	Peso/Weight
69223	220-240 V; 50/60 Hz	500 W	70°C (max)	5 bandejas / Trays	Ø33x22 cm	2,80 Kg
69123	220-240 V; 50/60 Hz	250 W	70°C (max)	5 bandejas / Trays (13x14)	Ø32x27 cm	2,45 Kg

► COCEDOR DE VAPOR



Cocedor al vapor

Cuiseur vapeur
Dampfkochgerät
Steam cooker
Painela de coção a vapor

Ref	€	W	U.Venta
69121	76,36	1000	1

Ref	Tensión/Voltage	Potencia/Power	Temperatura/Temp.	Capacidad/Capacity	Dimensiones/Sizes	Peso/Weight
69121	220-240 V; 50-/60 Hz	1000 W	100°C (max)	12 L	41x35x26,57 cm	3,16 Kg



Household use

Una forma muy saludable de cocinar los alimentos.
Mantiene todos los nutrientes, aromas y sabores de los alimentos.
Se pueden preparar varios alimentos simultáneamente sin que se mezclen sus sabores.

Une façon très saine de cuisiner les aliments.
Conserve tous les nutriments, les arômes et les saveurs des aliments.
Plusieurs aliments peuvent être préparés simultanément sans aucun mélange de saveurs.

Für eine äußers gesunde Zubereitung von Lebensmitteln
Nährstoffe, Geschmack und Aroma der Lebensmittel bleiben erhalten
Zubereitung mehrerer Lebensmittel gleichzeitig möglich, ohne
Geschmacksübertragung.

A very healthy way of cooking food.
Retains all the nutrients, aromas and flavours of food.
You can prepare several foods simultaneously without mixing their flavours.

Uma forma saudável de cozinhar os alimentos.
Conserva todos os nutrientes, aromas e sabores dos alimentos.
Permite preparar vários alimentos simultaneamente, sem que os seus sabores se misturem.

Numeración en bandejas
Numbering in trays



Cubeta para cocinar arroz
Container for cooking rice

Especial para todo tipo de frituras
Essential for all types of fried dishes



Destinada a un uso intensivo en restaurantes, bares, hoteles, etc.
Especial para todo tipo de frituras, permite freír gran cantidad de alimento.
Fabricada en acero inoxidable, exterior e interior, garantiza una gran durabilidad y resistencia.

Termostato de temperatura regulable.

Termostato de seguridad con rearme manual.

Mango termo resistente.

Sistema de fijación de la cesta para escurrir el aceite.

Indicador máximo-mínimo de nivel de aceite.

Panel extraíble para facilitar el mantenimiento y la limpieza.

Destinée à un usage intensif dans les restaurants, les bars, les hôtels, etc.
Spécial pour tout type de friture, permet de frire de grandes quantités d'aliments.
Fabriquée en acier inoxydable, extérieur et intérieur, elle garantit une grande durabilité et résistance.

Thermostat de température réglable.

Thermostat de sécurité avec réinitialisation manuelle.

Manche résistant à chaleur.

Système de fixation du panier pour égoutter l'huile.

Indicateur maximum-minimum du niveau d'huile.

Panneau extractible pour faciliter l'entretien et le nettoyage.

Für die intensive Nutzung in Restaurants, Bars, Hotels usw. konzipiert.

Für alle Frittierarten geeignet. Design für das Frittieren großer Mengen von Lebensmitteln.

Innen und außen aus rostfreiem Stahl, um eine lange Haltbarkeit und Beständigkeit zu gewährleisten.

Thermostat zur Temperaturregelung. Sicherheitsthermostat mit manueller Rücksetzung.

Wärmebeständiger Griff.

Korbbelegungs-system zum Abtropfen des Öls.

Ölstandsanzeige Max-Min.

Entnehmbare Schaltkasten zur Erleichterung der Wartung und Reinigung.

Intended for heavy-duty use in restaurants, bars, hotels, etc.

Essential for all types of fried dishes, it can fry a large amount of food.

Made of stainless steel, exterior and interior, guarantees great durability and resistance.

Adjustable temperature thermostat.

Safety thermostat with manual reset.

Heat resistant handle.

System for hanging the basket to drain the oil.

Minimum maximum oil level indicator.

Removable panel for easy maintenance and cleaning.

Destinada a um uso intensivo em restaurantes, bares, hotéis, etc.

Especial para todo o tipo de fritos, permite fritar uma grande quantidade de alimentos.

Exterior e interior em aço inoxidável, de grande durabilidade e resistência.

Termostato de temperatura regulável.

Termostato de segurança com rearme manual.

Mangó termoresistente.

Sistema de fixação do cesto para escorrer o óleo.

Indicador máximo/mínimo do nível de óleo.

Panel extraível para facilitar a manutenção e a limpeza.



Resistencia
Resistance



Resistencia
Resistance

Freidora PROFESIONAL

Friteuse

Friteuse

Fryer

Fritadeira

Ref	€	W	L	U.Venta	
69169	234,37	2500	6,0	1	Simple - Simple
69466	366,76	2500x2	6,0x2	1	Doble - Double

Ref	Tensión/Voltage	Potencia/Power	Temperat./Temp.	Capac./Capacity	Cont./Container	Cestillo/Basket	Dimensiones/Sizes	Peso/Weight
69169	220-240 V; 50/60 Hz	2500 W	50°C - 190°C	6,0 L	32,5 x 26,5 x 15 cm	24 x 20 x 10,5 cm	27 x 41 x 31 cm	5,50 Kg
69466	220-240 V; 50/60 Hz	2500 W x 2	50°C - 190°C	6,0 L x 2	32,5 x 26,5 x 15 cm	24 x 20 x 10,5 cm	55 x 41 x 31 cm	10,0 Kg



· *Semiprofessional use* ·

Fritadora

Friteuse
Friteuse
Fryer
Fritadeira

Ref	€	W	L	U.Venta	
69135	93,89	2000	3,50	1	Simple Simple
69170	188,10	2000x2	3,50x2	1	Doble Double

Ref	Tensión/Voltage	Potencia/Power	Temperatura/Temp.	Capacidad/Capacity	Dimensiones/Sizes	Peso/Weight
69135	220-240 V; 50/60 Hz	2000 W	190°C	3,50 L	41x22x21 cm	2,70 Kg
69170	220-240 V; 50/60 Hz	4000 W	190°C	3,50 x 2 L	41x39,5x21 cm	6,60 Kg



Dimensiones reducidas para unas prestaciones de gama alta, una pequeña gran fritadora

Dimensions réduites pour des prestations haut de gamme, une petite grande friteuse.
Kleine Abmessungen bei hoher Leistung, eine kleine großartige Friteuse.
Smaller dimensions for high-end features, a small but powerful fryer.
Dimensões reduzidas para umas prestações de gama alta, uma pequena grande fritadeira.

Ventana en la tapa
Window in the lid



Cubeta extraíble
Removable tray



Las paredes exteriores se mantendrán frías en todo momento.
The external walls will be kept cool at all times.

· *Household use* ·

Fritadora

Friteuse
Friteuse
Fryer
Fritadeira

Ref	€	W	L	U.Venta
69199	106,24	2800	2,5	1

Ref	Tensión/Voltage	Potencia/Power	Temperat./Temp.	Temp./Timer	Capacidad/Capacity	Cestillo/Basket	Dimensiones/Sizes	Peso/Weight
69199	220-240 V; 50/60 Hz	2800 W	130-190°C	0-30 min	2,50 L	18x17x10 cm	34x29x25 cm	3,90 Kg

▶ FREIDORAS CON GRIFO

Professional use



Destinada a un uso intensivo en restaurantes, bares, hoteles, etc.
Especial para todo tipo de frituras, permite freír gran cantidad de alimento.
Fabricada en acero inoxidable, exterior e interior, garantiza una gran durabilidad y resistencia.
Termostato de temperatura regulable.
Termostato de seguridad con rearme manual.
Mango termo resistente.
Sistema de fijación de la cesta para escurrir el aceite.
Indicador máximo-mínimo de nivel de aceite.
Gracias a su grifo incorporado, permite extraer fácilmente el aceite del contenedor.
Panel extraíble para facilitar el mantenimiento y la limpieza.

Destinée à un usage intensif dans les restaurants, les bars, les hôtels, etc.
Spécial pour tout type de friture, permet de frire de grandes quantités d'aliments.
Fabriquée en acier inoxydable, extérieur et intérieur, elle garantit une grande durabilité et résistance.
Thermostat de température réglable.
Thermostat de sécurité avec réinitialisation manuelle.
Manche résistant à chaleur.
Système de fixation du panier pour égoutter l'huile.
Indicateur maximum-minimum du niveau d'huile.
Grâce à son robinet intégré, elle permet d'extraire facilement l'huile du conteneur.
Panneau extractible pour faciliter l'entretien et la nettoyage.

Für die intensive Nutzung in Restaurants, Bars, Hotels usw. konzipiert. Für alle Fritierarten geeignet. Design für das Fritieren großer Mengen von Lebensmitteln. Innen und außen aus rostfreiem Stahl, um eine lange Haltbarkeit und Beständigkeit zu gewährleisten.
Thermostat zur Temperaturregelung. Sicherheitsthermostat mit manueller Rücksetzung.
Wärmebeständiger Griff.
Korbbelegungs-system zum Abtropfen des Öls.
Ölstandsanzeige Max.-Min.
Dank dem eingebauten Ablasshahn lässt sich das Öl leicht aus dem Behälter entfernen.
Entnehmbare Schallkasten zur Erleichterung der Wartung und Reinigung.

Intended for heavy-duty use in restaurants, bars, hotels, etc.
Essential for all types of fried dishes, it can fry a large amount of food.
Made of stainless steel, exterior and interior, guarantees great durability and resistance.
Adjustable temperature thermostat.
Safety thermostat with manual reset.
Heat resistant handle.
System for hanging the basket to drain the oil.
Minimum-maximum oil level indicator.
Thanks to its built-in tap, it allows easy extraction of oil from the container.
Removable panel for easy maintenance and cleaning.

Destinada a um uso intensivo em restaurantes, bares, hotéis, etc.
Especial para todo o tipo de fritos, permite fritar uma grande quantidade de alimentos.
Exterior e interior em aço inoxidável, de grande durabilidade e resistência.
Termostato de temperatura regulável.
Termostato de segurança com rearme manual.
Mango termorresistente.
Sistema de fixação do cesto para escoar o óleo.
Indicador máximo/mínimo do nível de óleo.
A torneira incorporada permite extrair facilmente o óleo do recipiente da fritadeira.
Painel extraível para facilitar a manutenção e a limpeza.



Resistencia
Resistance

Cerrado
Closed

Abierto
Open



Resistencia
Resistance

Freidora con grifo PROFESIONAL

Friteuse avec robinet
Friteuse mit Wasserhahn
Fryer with tap
Fritadeira com torneira

Ref	€	W	L	U. Venta
69468	248,48	3250	8,0	1 Simple - Simple
69469	473,93	3250x2	8,0x2	1 Doble - Double

Ref	Tensión/Voltage	Potencia/Power	Temperat./Temp.	Capac./Capacity	Cont./Container	Cestillo/Basket	Dimensiones/Sizes	Peso/Weight
69468	220-240 V; 50/60 Hz	3250 W	50°C - 190°C	8,0 L	24x30x20 cm	18,5x24x14 cm	27x41x42 cm	7,00 Kg
69469	220-240 V; 50/60 Hz	3250 W x 2	50°C - 190°C	8,0 L x 2	24x30x20 cm	18,5x24x14 cm	55x41x42 cm	14,0 Kg



Semiprofessional use

Freidora con grifo

Friteuse avec robinet
Friteuse mit Ablaufhahn
Fryer with tap
Fritadeira com torneira

Ref	€	W	L	U.Venta
69134	165,59	2500	4,0	1

Ref	Tensión/Voltage	Potencia/Power	Temperatura/Temp.	Capacidad/Capacity	Dimensiones/Sizes	Peso/Weight
69134	220-240 V; 50/60 Hz	2500 W	~190°C	4,00 L	44,3x24,7x27,5 cm	2,94 Kg

► FREIDORA DE AIRE

Household use



Cestillo/Basket
16,7x16,6x8,7 cm



Ideal para todas aquellas personas preocupadas por una dieta saludable. Permite preparar deliciosas y sanas recetas sin apenas aceite. Reduce el consumo de grasas conservando los nutrientes y sabores de los alimentos.

Funciona por aire caliente que reparte el aceite por todos los alimentos consiguiendo una cocción homogénea.

Sistema rotativo que distribuye el aire por todo el interior conservando el sabor de los alimentos.

Cocina en poco tiempo y no produce malos olores ni humos.

Idéale pour tous ceux qui souhaitent avoir un régime alimentaire sain. Permet de préparer des recettes délicieuses et saines presque sans huile. Réduit la consommation de graisses en conservant les nutriments et les saveurs des aliments.

Fonctionne avec de l'air chaud qui distribue l'huile à travers tous les aliments, obtenant ainsi une cuisson homogène.

Système rotatif qui distribue l'air à travers tout l'intérieur, conservant ainsi la saveur des aliments.

Cuisine rapidement et ne produit ni mauvaises odeurs ni fumées.

Das ideale Küchengerät für gesundheitsbewusste Genießer. Schon mit ganz wenig Öl kreieren Sie gesunde und leckere Rezepte. Reduziert den Fettverbrauch und bewahrt die Nährstoffe und den Geschmack der Lebensmittel.

Arbeitet mit Heißluft-Zirkulation, die das Öl gleichmäßig im Innern verteilt und alles gut durchkocht.

Die heiße Luft zirkuliert im Innern des Geräts und erhält den vollen Geschmack. Kocht schnell und geruchlos, raucht nicht.

Ideal for all those who are concerned about a healthy diet.

Enables you to prepare delicious and healthy recipes with hardly any oil. Reduces the consumption of fats, conserving the nutrients and flavours of food.

Works thanks to hot air that spreads the oil across the food to achieve even cooking. Rotating system that distributes air throughout the interior, preserving the taste of food.

Cooks quickly and does not give off unpleasant odours or fumes.

Idéal para todas as pessoas que querem seguir uma dieta saudável. Permite preparar receitas deliciosas e saudáveis praticamente sem utilizar óleo. Reduz o consumo de gorduras conservando os nutrientes e os sabores dos alimentos. Funciona utilizando ar quente, que distribui o óleo por todos os alimentos, conseguindo uma cocção homogénea.

Sistema rotativo que distribui o ar pelo interior do recipiente, conservando o sabor dos alimentos.

Cozinha em pouco tempo, e não produz fumo nem maus cheiros.



Freidora de aire

Friteuse à air chaud
Heißluft Friteuse
Air fryer
Fritadeira de ar

Ref	€	W	L	U.Venta
69311	161,54	1500	2,0	1

Ref	Tensión/Voltage	Potencia/Power	Temperatura/Temp.	Capacidad/Capacity	Temporiz./Timer	Dimensiones/Sizes	Peso/Weight
69311	220-240 V; 50/60 Hz	1500 W	80 - 200°C	2,00 L	0 - 30 min	38,5x25,5x33,39 cm	4,75 Kg

HORNO

Household use

Sencillo e intuitivo
Easy to use and intuitive



Fabricado en acero inoxidable de alta calidad.
Adecuado para cocinas pequeñas gracias a su tamaño compacto.
Versátil: Hasta 6 funciones para preparar todo tipo de recetas.

Fabricado en acier inoxydable de grande qualité.
Adapté pour de petites cuisines grâce à son format compact.
Versatile : Jusqu'à 6 fonctions pour préparer tout type de recettes.

Hergestellt aus hochwertigem rostfreiem Stahl.
Geignet für kleine Küchen dank seiner kompakten Größe.
Vielseitig: Bis zu 6 Funktionen, um alle Arten von Rezepten zuzubereiten.

Made of high-quality stainless steel.
Suitable for small kitchens thanks to its compact size.
Versatile: Up to 6 functions for preparing all kinds of recipes.

Fabricado em aço inoxidável de alta qualidade.
O seu tamanho compacto torna-o adequado para cozinhas pequenas.
Versátil: 6 funções, para preparar todo o tipo de receitas.

Horno - Grill

Four - Grill
Ofen - Grill
Oven - Grill
Forno - Grill

Ref	€	W	L	U.Venta
69326	141,52	1500	26	1
69342	206,05	2000	42	1



Pincho mariposa
Butterfly skewer

Pinza bandeja
Tray tong

Mango pincho mariposa
Handle of butterfly skewer

Parrilla
Wire rack

Bandeja horno
Oven tray

Ref	Tensión/Voltage	Potencia/Power	Temperatura/Temp.	Capacidad/Capacity	Dim. interior/Int. size	Dimensiones/Sizes	Peso/Weight
69326	220-240 V; 50/60 Hz	1500 W	100 - 250 °C	26 L	36,5x31x22 cm	51x37x30 cm	7,65 Kg
69342	220-240 V; 50/60 Hz	2000 W	100 - 250 °C	42 L	40,5x33,5x28 cm	41,5x55x36 cm	10 Kg

MICROONDAS

Professional use



Diseñado para uso intensivo, reduciendo el tiempo de calentamiento un 60%.
Materiales robustos y mayores medidas de seguridad. Mayor protección del usuario a radiaciones.
Base de cerámica plana, sin plato de vidrio. Posibilidad de calentar platos grandes.
Cavidad interior de acero inoxidable (más higiénico). Calentamiento homogéneo.

Conçu pour un usage intensif, réduisant le temps de chauffe de 60%.
Matériaux robustes et mesures de sécurité accrues. Protection plus importante de l'utilisateur vis-à-vis des radiations.
Base en céramique plate, sans plateau en verre. Possibilité de chauffer de grandes assiettes.
Cavité intérieure en acier inoxydable (plus hygiénique). Chauffe homogène.

Für eine intensive Benutzung ausgelegt, die Aufwärmzeit ist um 60% reduziert.
Robuste Materialien und bessere Sicherheitsmaßnahmen. Bessere Schutz vor Wärmestrahlung.
Glatte Keramikboden, ohne Glasplatte. Es können große Teller erwärmt werden.
Innenausr aus Edelsahl (hygienischer). Gleichmäßige Erwärmung.

Designed for intensive use, reduces heating time by 60%.
Robust materials and greater safety measures. Greater protection against heat for the user.
Flat ceramic base with no glass plate. It can heat large dishes.
Inside cavity made of stainless steel (more hygienic). Even heating.

Concebido para um uso intensivo, reduzindo em 60% o tempo de aquecimento.
Materiais robustos e medidas de segurança, para uma maior proteção do usuário contra as radiações.
Base cerâmica plana, sem prato de vidro. Permite aquecer pratos de grandes dimensões.
Cavidade interior em aço inoxidável (mais higiénico). Aquecimento homogéneo.



Horno microondas Profesional

Four à micro ondes Professionnel
Mikrowelle Professional
Professional microwave oven
Microondas Profissional

Ref	€	W	L	U.Venta
69325	541,26	1000	25	1

Ref	Tensión/Voltage	Potencia/Power	Capacidad/Capacity	Dimensiones/Sizes	Peso/Weight
69325	220-240 V / 50 Hz	1000 W	25 L	51x43x31 cm	14,60 Kg



Household use

Horno microondas con plato giratorio + Grill

Four micro-ondes avec plateau tournant + Grill

Mikrowelle mit Drehteller + Grill

Microwave oven with turntable + Grill

Microondas com prato giratório + Grill

	Ref	€	L	U.Venta
A	69323	226,59	23	1
B	69324	246,51	25	1
C	69330	296,83	30	1

Ref	Tensión/Voltage	Potencia/Power	Pot. Grill/Grill power	Capacidad/Capacity	Plato/Plateau	D. int/Int. size	Dimensiones/Sizes	Peso/Weight
69323	220-240 V; 50 Hz	800 W	1000 W	23 L	Ø27 cm	33x32x20,5 cm	51x42x28 cm	15,5 Kg
69324	220-240 V; 50 Hz	900 W	1000 W	25 L	Ø31,5 cm	35,5x33x21 cm	51x43x30 cm	14,3 Kg
69330	220-240 V; 50 Hz	900 W	1000 W	30 L	Ø31,5 cm	33x35,5x22,5 cm	52x40x32,5 cm	15,6 Kg



Plato giratorio de Ø24,5 cm
Rotating plate Ø24.5 cm

Panel de control analógico
Analogue control panel



Plato giratorio, asegura un reparto y un calentamiento uniforme.
Gran potencia y capacidad interior, calienta en segundos o cocina en minutos.
Incluye la función descongelar.

Plato giratório, assegura uma distribuição e um aquecimento uniforme.
Grande potência e capacidade interior, aquece em segundos e cozinha em minutos.
Inclui a função descongelar.

Drehteller, gewährleistet gleichmäßige Erwärmung und Verteilung.
Große Leistung und Innenkapazität, erwärmt in wenigen Sekunden und kocht in wenigen Minuten. Einschließlich Auftaufunktion.

Turntable ensures even distribution and heating.
Great power and interior capacity, heats in seconds and cooks in minutes.
Includes defrost function.

Plato giratório, assegura uma distribuição e um aquecimento uniforme.
Grande potência e capacidade interior.
Aquece em segundos e cozinha em poucos minutos. Inclui a função descongelar.

Household use

Microondas WHITE

Micro-ondes

Mikrowelle

Microwave

Microondas

Ref	€	W	L	U.Venta
69322	132,07	700	20	1

Ref	Tensión/Voltage	Potencia/Power	Grill	Temporizador/Timer	Capacidad/Capacity	Plato/Plate	D. interiores/Sizes int.	Dimensiones/Sizes	Peso/Weight
69322	220-240 V; 50 Hz	700 W	NO	30 min	20 L	Ø24,5 cm	31,5x29,7x19,8 cm	45,2x26,2x33,9 cm	10,5 Kg

▶ PLACAS DE INDUCCIÓN

Professional use



Placas de inducción rápidas, eficaces, seguras, fiables y de gran capacidad de calentamiento.

Sus diseños portátiles y compactos resultan ideales para su uso en cualquier lugar.

Botones táctiles, intuitivos y fáciles de utilizar con un toque suave. 40% ahorro de tiempo y energía respecto a otras placas convencionales.

Plaques à induction rapides, efficaces, sûres, fiables et d'une grande capacité de chauffe.

Sa conception portable et compacte est idéale pour une utilisation n'importe où.

40% de gain de temps et d'économies d'énergie par rapport à d'autres plaques conventionnelles.

Schnelles, sicheres, zuverlässiges Induktionskochfeld mit hervorragender Heizleistung.

Aufgrund seines tragbaren und kompakten Designs ist es überall einsetzbar.

40 % Zeit- und Energieersparnis verglichen mit anderen herkömmlichen Kochfeldern.

Fast, efficient, safe, reliable induction hob with high heating capacity.

Its portable and compact design is ideal for use anywhere.

40% saving in time and energy compared to other conventional hobs.

Placa de indução rápida, eficaz, segura, fiável e de grande potência.

O seu design portátil e compacto permite a sua utilização em qualquer lugar.

Botões tácteis, intuitivos e fáceis de utilizar, com um suave toque.

Poupança de 40% em tempo e energia, em comparação com as placas convencionais.

Superficie de calentamiento
Heating surface

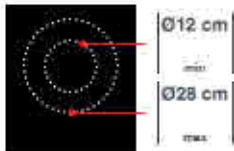

Superficie de calentamiento
Heating surface

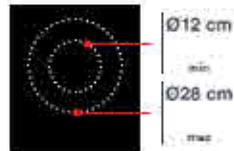

IPX3

proof

Placa Inducción Profesional

Plaque Induction Professionnelle

Prof-Induktionsplatte

Professional induction cooktop

Placa de indução Profissional

Ref	€	W	U.Venta
69132	374,75	3500	1

Placa Inducción Profesional

Plaque Induction Professionnelle

Prof-Induktionsplatte

Professional induction cooktop

Placa de indução Profissional

Ref	€	W	U.Venta
69337	316,85	2700	1

Ref	Tensión/Voltage	Potencia/Power	Niveles Pot./P. levels	Temperatura/Temp.	Reloj/Timer	Dimensiones/Sizes	Peso/Weight
69132	220-240 V; 50/60 Hz	3500 W	17	35°C - 240°C	0 - 180 min	34x43x12 cm	7,35 Kg
69337	220-240 V; 50/60 Hz	2700 W	10	60°C - 240°C	0 - 180 min	30x39x10 cm	5,40 Kg

Superficie de calentamiento
Heating surface

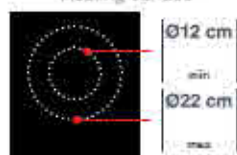

Posibilidad de encastrar
Encastrable option

Superficie de calentamiento
Heating surface



Placa de Inducción

Table de cuisine à induction
Induktionskochfeld
Induction Cooker
Placa de indução

Ref	€	W	U.Venta
69032	242,57	2000	1



Placa de Inducción SLIM

Table de cuisine à Induktion
Induktionskochfeld
Induction cooker
Placa de indução

Ref	€	W	U.Venta
69332	137,57	2000	1

Ref	Tensión/Voltage	Potencia/Power	Niveles Pot. /P. levels	Reloj/Timer	Dimensiones/Sizes	Peso/Weight
69032	220-240 V, 50/60 Hz	2000 W	6	0 - 180 min	31x36x7,5 cm	2,90 Kg
69332	220-240 V, 50/60 Hz	2000 W	8	0 - 180 min	30x37x4,5 cm	2,67 Kg

Superficie de calentamiento
Heating surface



Posibilidad de encastrar
Encastrable option

Superficie de calentamiento
Heating surface

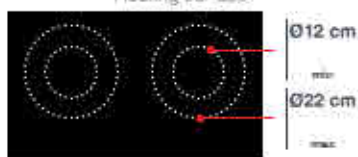

Posibilidad de encastrar
Encastrable option



Placa Inducción doble

Plaque induction double
Induktionskochfeld doppelt
Double induction cooktop
Placa de indução dupla

Ref	€	W	U.Venta
69033	397,16	1800+1300	1



Placa Inducción DUAL

Plaque induction
Induktionskochfeld doppelt
Induction cooktop
Placa de indução

Ref	€	W	U.Venta
69333	234,68	2000+1500	1

Ref	Tensión/Voltage	Potencia/Power	Niveles Pot. /P. levels	Reloj/Timer	Dimensiones/Sizes	Peso/Weight
69033	220-240 V, 50/60 Hz	1800 W +1300 W	8	0 - 99 min	29x51x9 cm	4,50 Kg
69333	220-240 V, 50/60 Hz	2000 W + 1500 W	7	0 - 180 min	60x34x7,5 cm	5,20 Kg

Professional use



Inox

Placa Inducción Wok Profesional

Plaque à induction wok Professionnelle
Induktionskochplatte Wok Professional
Induction cooktop wok Professional
Placa indução wok Profissional

Ref	€	W	U. Venta
69138	389,17	3500	1

Cuerpo fabricado en 3 capas: acero inoxidable 18/10, aluminio, acero inoxidable 18%. La capa exterior, es de acero inoxidable con componentes ferríticos, lo que la convierte totalmente compatible con las cocinas de inducción. El mango fabricado en acero inoxidable 18/10 y recubierto con un protector térmico de silicona

Body manufactured in a 3-layered: 18/19 stainless steel, aluminium, 18% stainless steel. Exterior layer of stainless-steel with ferritic materials, making it completely compatible with induction cookers. The grip are made in 18/10 stainless steel and covered in a silicon heat protection.



Wok Trimetal

Wok Trimetal
Wok, Trimetal
Trimetal wok
Wok Trimetal

Ref	€	Ø (cm)	L
53836	151,48	36	5,50



Ref	Tensión/Voltage	Potencia/Power	Temperatura/Temp	Tiempo/Timer	Dimensiones/Sizes	Peso/Weight
69138	220-240 V, 50/60 Hz	3500 W	60°C - 240°C	0 - 180 min	34x44,5x12,5 cm	7,50 Kg

▶ PLACA VITROCERÁMICA

Superficie de calentamiento
Heating surface



Placa vitrocerámica VITRO

Plaque vitrocéramique
Keramikkochfeld
Ceramic hob
Placa vitrocerámica

Ref	€	W	U. Venta
69232	97,63	2000	1



Household use

Placa vitrocerámica rápida, eficaz, segura, fiable y de gran capacidad de calentamiento.

Su diseño portátil y compacto resulta ideal para su uso en cualquier lugar. Botones táctiles, intuitivos y fáciles de utilizar con un toque suave. Indicadores luminosos. Regulable en potencia y temperatura. Temporizador de 240 minutos con avisador acústico y auto desconexión. Dispone de función de bloqueo de seguridad para niños.

Plaque vitrocéramique rapide, efficace, sûre, fiable et d'une grande capacité de chauffe. Sa conception portable et compacte est idéale pour une utilisation n'importe où. Boutons tactiles, intuitifs et faciles à utiliser avec un toucher doux. Indicateurs lumineux. Réglable en puissance et en température. Minuteur de 240 minutes avec alerte sonore et arrêt automatique. Dispose d'une fonction de blocage de sécurité pour les enfants.

Schnelles, sicheres, zuverlässiges Keramikkochfeld mit hervorragender Heizleistung. Aufgrund seines tragbaren und kompakten Designs ist es überall einsetzbar. Intuitive, bedienereundliche Soft-Touch-Tastfelder. Leuchtanzeigen. Regulierbare Leistung und Temperatur. Zeitschaltuhr bis 240 Minuten mit akustischem Warnsignal und automatischer Abschaltung. Kindersicherungsfunktion.

Fast, efficient, safe, reliable ceramic hob with high heating capacity. Its portable and compact design is ideal for use anywhere. Intuitive and easy to use soft touch buttons. Luminous indicators. Adjustable power and temperature. 240-minute timer with audible warning and auto-off. Includes a child safety lock function.

Placa vitrocerámica rápida, eficaz, segura, fiable y de gran potencia. O seu design portátil e compacto permite a súa utilización en calquera lugar. Botões táctiles, intuitivos e fáciles de utilizar, con un suave toque. Indicadores luminosos. Potencia e temperatura reguláveis. Temporizador de 240 minutos con avisador acústico e desconexión automática. Función de bloqueo de segurança à prova de crianças.



Ref	Tensión/Voltage	Potencia/Power	Temperatura/Temp.	Temporizador/Timer	Ø cocción/Cooking Ø	Dimensiones/Sizes	Peso/Weight
69232	220-240 V; 50/60 Hz	2000 W (8 levels)	60°C - 600°C (8 levels)	0 - 240 min (8 levels)	10 cm / 20 cm	39x32x5,5 cm	2,60 Kg

PLACAS GRILL

Professional use



Raspar los residuos de los alimentos y el carbón de las planchas
Used to scrape food and charcoal residue from grills.

Una sola pieza
de aluminio fundido
A single piece of cast aluminium



AL

Aluminium

Rasqueta Profesional para grill

Racloir Professionnel pour grill
Professioneller grillschaber
Professional grill scraper
Raspador Profesional para grill

Ref	€	cm	L Cuchilla (cm)	U.Venta
67034	60,80	42x15x12	15	1



Fabricada en acero inoxidable.
Protector de salpicaduras.
Placa con superficie lisa de acero laminado y rectificado, calentamiento uniforme.
Control de temperatura por termostato hasta 300°C.
Depósito recoge grasas.
Especialmente indicada para bares, restaurantes, hoteles, etc.
Para hacer a la plancha carnes, pescados, verduras, hortalizas, crepes, huevos...

Fabriquée en acier inoxydable.
Protection contre les éclaboussures.
Plaque avec surface lisse en acier laminé et rectifié, chauffe uniforme.
Contrôle de température par thermostat jusqu'à 300°C.
Réservoir ramasse-grasses.
Spécialement indiquée pour les bars, restaurants, hôtels, etc.
Pour faire à la plancha des viandes, poissons, légumes, crêpes, œufs

Aus rostieren: Stahl hergestellt.
Spritzschutz.
Ebene Grillplatte aus laminiertem, plangeschliffenem Edelstahl, gleichmäßige Erwärmung.
Temperaturregelung mit Thermostat bis 300 °C.
Fettauffangbehälter.
Besonders für Gaststätten, Restaurants, Hotels, usw. geeignet.
Zum Grillen von Fleisch, Fisch, Gemüse, Crêpes, Eier usw.

Made in stainless steel.
Splash guard.
Laminated steel, flat surface griddle with uniform heating.
Thermostat temperature control up to 300°C.
Oil collector.
Especially made for bars, restaurants, hotels, etc.
To cook meat, fish, vegetables, crepes and eggs on the griddle.

Fabricada em aço inoxidável.
Inclui protetor contra salpicaduras.
Placa com superfície lisa de aço laminado e retificado, de aquecimento uniforme.
Controlo de temperatura por termostato até 300 °C.
Depósito para recolha de gorduras.
Especialmente indicada para bares, restaurantes, hotéis, etc.
Para grelhar carnes, peixes, verduras, hortaliças, crepes, ovos, etc.



Placa grill PROFESIONAL

Grill Professionnel
Prof-Grill
Professional grill plate
Grelhador Profissional

Ref	€	W	Área cocción	U.Venta
69379	331,69	3000	40x40 cm	1
69179	681,22	6000	61x40 cm	1



Ref	Tensión/Voltage	Potencia/Power	Temperat./Temp.	Zona trabajo/Working zone	Superf. placa/Grill surface	Dimensiones/Sizes	Peso/Weight
69379	220-240 V; 50/60 Hz	3000 W	300°C	1	40x40 cm	641x51x26 cm	27 Kg
69179	220-240 V; 50/60 Hz	6000 W	300°C	2	61x40 cm	61,5x51x26 cm	37 Kg



Estructura de acero inoxidable
Stainless steel structure

Techo móvil
Mobile roof



Professional use

Estructura de acero inoxidable.
Ideal para calentar, asar, tostar o gratinar directamente los alimentos.
Placa de calentamiento y techo móvil, ajusta a la posición deseada.

Structure en acier inoxydable
Idéale pour chauffer, rôti, griller ou gratiner directement les aliments.
Plaque de chauffe et toit mobile avec réglage de la position souhaitée

Struktur aus rostfreiem Stahl
Ideal zum direkten Aufwärmen, Braten, Rosten oder Grillieren von Lebensmitteln
Bewegliche Heizplatte und Abdeckung zum Einstellen der gewünschten Position

Stainless steel structure
Ideal for directly heating, roasting, toasting or browning food
Movable heating plate and roof, adjusting the desired position

Estrutura de aço inoxidável
Ideal para aquecer, assar, tostar ou gratinar diretamente os alimentos.
Placa de aquecimento e cobertura móvel, ajustável à posição desejada

Salamandra Profesional

Salamandre Professionnelle
Professioneller Grill
Professional salamander grill
Salamandra Profissional

Ref	€	W	U.Venta
69197	1.047,36	4000	1

Ref	Tensión/Voltage	Potencia/Power	Temperatura/Temp.	Plancha/Grill	Dimensiones/Sizes	Peso/Weight
69197	220-240 V, 50/60 Hz	4000 W	50°C - 300°C	59x32 cm	60x45x50 cm	49 Kg



Regulador de temperatura desmontable
Régulateur de température démontable
Abnehmbarer Temperaturregler
Detachable temperature controller
Regulador de temperatura desmontable



Doble zona de cocción
Double espace de cuisson
Zwei Garbereiche
Dual cooking area
Dupla zona de coqção



Bandeja recoge grasas
Plateau recueille-graisse
Fettzufangwanne
Grease tray
Bandeja para recolher as gorduras



Asas aislantes de calor
Poignées isolantes de chaleur
Wärmeisolierende Griffe
Heat-insulating handles
Asas isolantes do calor



Household use

Placa de aluminio fundido antiadherente de gran calidad, libre de PFOA.
Doble zona de cocción para cocinar todo tipo de alimentos:
* Grill: Ideal para asar carnes, pescados, marisco, hamburguesas o verduras.
* Lisa: Ideal para preparar tortitas, huevos, tostadas o verduras.
Alcanzan rápidamente la temperatura indicada.
Garantizan una cocción uniforme por toda la superficie.
Regulador de temperatura desmontable.
La ranura central hace que la grasa se deposite en la bandeja recoge-grasas.
Las asas con recubrimiento aislante de calor proporcionan seguridad.

High-quality, non-stick, PFOA-free cast aluminium plate
Dual cooking area for cooking all kinds of food
* Grill: Ideal for grilling meat, fish, seafood, hamburgers or vegetables
* Smooth: Ideal for making pancakes, eggs, toast or vegetables
Quickly reaches the specified temperature
Ensures even cooking across the entire surface
Detachable temperature controller
Fat runs down the central groove and is gathered in the grease tray
Handles with heat-insulating coating for added safety

Plancha & Grill

Plancha & Grill
Grillplatte
Grill plate
Prancha & Grelhador

Ref	€	W	U.Venta
59227	72,11	2000	1

Ref	Tensión/Voltage	Potencia/Power	Temperatura/Temp.	Parilla/Grill	Dimensiones/Sizes	Peso/Weight
69227	220-240 V, 50/60 Hz	2000 W	0 - 230°C	52x30 cm	61x32,5x6 cm	3,20 Kg



Ranura central recoge-grasas
Central groove for gathered the grease



300°C
max Household use

Plancha grill TEPPANYAKI

Grill, Electrique TEPPANYAKI
Elektro-Grill, TEPPANYAKI
TEPPANYAKI Electric Grill
Grillador Eléctrica TEPPANYAKI

Ref	€	W	U.Venta
69133	323,49	1280	1

Ref	Tensión/Voltage	Potencia/Power	Temperatura/Temp.	Parrilla/Grill	Dimensiones/Sizes	Peso/Weight
69133	220-240 V, 50/60 Hz	1280 W	300°C (max)	43x27 cm	60x34x8 cm	5,50 Kg



Calentamiento por infrarrojos y rápido.
Dos zonas independientes de cocción y zona de calentamiento.
6 niveles de potencia.
La placa de cocción se puede meterse en el lavavajillas.
Permite el uso de útiles de cocina metálicos.
Mejora el rendimiento eléctrico 15% en comparación con otros grillas de aluminio fundido.

Chauffe par infrarouges et rapide.
Deux zones indépendantes de cuisson et zone de chauffe.
6 niveaux de puissance.
La plaque de cuisson peut être lavée au lave-vaisselle.
Permet l'utilisation d'accessoires de cuisine métalliques.
Améliore le rendement électrique de 15% par rapport à d'autres grilles en fonte d'aluminium.

Schnelle Infrarot-Erwärmung.
Zwei unabhängige Kochfelder und Erwärmungsfeld.
6 Leistungsstufen.
Die Kochplatte kann im Geschirrfür gewaschen werden.
Es kann Kochgeschirr aus Metall verwendet werden.
Verbesserte elektrische Leistung um 15% im Vergleich zu anderen Grills aus Aluminiumguss.

Fast infrared heating system.
Two independent cooking areas and heating area.
6 power levels.
The cooking plate is dishwasher friendly.
Allows the use of metal kitchen utensils.
Improves energy performance by 15% in comparison with other cast aluminium grills.

Aquecimento por infravermelhos e rápido.
Duas zonas independentes de coção e zona de aquecimento.
6 níveis de potência.
A placa de coção pode limpar-se na máquina de lavar loiça.
Permite o uso de utensílios de cozinha metálicos.
Melhora o rendimento elétrico em 15%, em comparação com outras grelhadores de alumínio fundido.

GRILL ABATIBLE

Professional use



Placa superior regulable en altura
Height adjustable top plate



Estructura de acero inoxidable
Stainless steel structure

Plancha Grill

Grill
Grill
Grill
Grillbar

Ref	€	W	U.Venta
69166	399,13	2200	1 SIMPLE
69167	522,92	4400	1 DOBLE DOUBLE

Ideal para preparar carnes, pescados, verduras, bocadillos, etc.
Doble placa ondulada. Placa superior regulable en altura.
Bandeja recoge grasas y mango aislante térmico.

Ideal for preparing meats, fish, vegetables, sandwiches, etc.
Double ribbed plate. Height adjustable top plate.
Grease tray and thermal insulation handle.



Ref	Tensión/Voltage	Tensión/Voltage	Potencia/Power	Temp./Temp.	Temp./Temp.	Dimensiones/Sizes	Peso/Weight
69166	SIMPLE	220-240 V, 50/60 Hz	2200 W	300°C / 572°F (max)	50°C / 122°F (min)	31x31x20 cm	25 Kg
69167	DOBLE DOUBLE	220-240 V, 50/60 Hz	4400 W	300°C / 572°F (max)	50°C / 122°F (min)	57x31x20 cm	35 Kg



Abatible a 180°
Opens 180°



Regulación en altura
Height-adjustable



Bandeja recoge grasas
Drip tray



Incluye espátula
Includes spatula

Cocina de forma más sana, sin apenas aceite
Cook more healthily with hardly any oil



Grill abatible PRO

Grill rabattable
Klappgrill
Contact grill
Grelhador rebatível

Ref	€	W	U.Venta
69574	231,78	2000	1



Grill de gran calidad y robusto para uso profesional.
Placas extraíbles de aluminio fundido antiadherente de gran calidad, libre de PFOA.
Doble zona de cocción:
* Grill (27x22 cm): Ideal para asar carnes, pescados, marisco, hamburguesas o verduras.
* Lisa (27x22 cm): Ideal para preparar tortitas, huevos, tostadas o verduras.
Alcanza rápidamente la temperatura indicada. Garantiza una cocción uniforme por toda la superficie.
Regulación en altura.
Regulador de potencia y temporizador de 30 minutos.
Fácil extracción (botón) y colocación de las placas para facilitar su limpieza.
Bandeja recoge grasas. Base antideslizante.
Incluye espátula para la limpieza de las placas.

Grill de grande qualitat i robuste a úsage professional.
Plaquas extraïbles en fons d'alumini antiadhèsit de gran qualitat, sense PFOA.
Doble espai de cuissó.
* Grill (27x22 cm): Ideal per grillar carnes, peixos, mariscs, hamburgueses o verdures.
* Lisa (27x22 cm): Ideal per preparar pastes, galetes, ous, tostats o verdures.
Atenint ràpidament la temperatura indicada. Garantint una cuissó uniforme sobre tota la superfície.
Règlage en altura.
Règlageur de potència i minuteria de 30 minuts.
Fàcil extracció (botó) i instal·lació de les plaques per facilitar el neteig.
Platau ramasse greix. Base antideslizant.
Inclou una spatula per al neteig de les plaques.

Hochwertiger und beständiger Grill für Gewerbe.
Ernehbare Grillplatten aus gegossenem Aluminium mit hochwertiger Anti-Haftbeschichtung ohne PFOA.
Doppelkochbereich (52x30 cm) für die Zubereitung jede Art von Mehlzaken.
* Grillgitter (27x22 cm): Ideal zum Grillen von Fleisch, Fisch, Meeresfrüchten, Burger oder Gemüse.
* Grillplatte (27x22 cm): Ideal für die Herstellung von Pfannkuchen, Eiern, Toast oder Gemüse.
Erreicht schnell die angegebene Temperatur. Sorgt für gleichmäßiges Garen auf der gesamten Oberfläche.
Höhenverstellbar.
Leistungs- und Temperaturregler (max. 30 min).
Grillplatten lassen sich einfach per Knopfdruck entnehmen und reinigen.
Mit Fettwanne. Rutschfester Sockel.
Reinigungsschaber für Grillplatten inbegriffen.

Robust, high quality grill for commercial use.
High quality, non-stick, PFOA free, cast aluminium grill plates.
Dual cooking area.
* Grill (27x22 cm): Ideal for grilling meat, fish, sea food, hamburgers or vegetables.
* Smooth (27x22 cm): Ideal for making pancakes, eggs, toast or vegetables.
Quickly reaches the specified temperature. Ensures even cooking across the entire surface.
Height adjustable.
30-minute timer and power regulator.
Grill plates are easy to remove (button) and replace, making them easy to clean.
Drip tray. Non-slip base.
Includes spatula for cleaning the grill plates.

Grill robusto e de grande qualificação, para uso profissional.
Placas extraíveis de alumínio fundido, com revestimento antiaderente de grande qualificação, sem PFOA.
Dupla zona de cocção.
* Grill (24,5x30 cm): Ideal para assar carnes, pescados, mariscos, hambúrgueses e verduras.
* Lisa (24,5x30 cm): Ideal para preparar tortitas, ovos, toasts ou verduras.
Alcança rapidamente a temperatura indicada. Garantia uma cocção uniforme em toda a superfície.
Regulação em altura.
Regulador de potência e temporizador de 30 minutos.
Fácil extração (botão) e colocação das placas, para facilitar a sua limpeza.
Bandeja recolhadora de gorduras. Base antiderrapante.
Inclui espátula para a limpeza das placas.

Ref	Tensión/Voltage	Potencia/Power	Temperatura/Temp.	Temporizador/Timer	Parrilla/Grill	Dimensiones/Sizes	Peso/Weight
69574	220-240 V, 50/60 Hz	2000 W	0 - 230 °C	0 - 30 min	27x22 cm	38x35x17 cm	6,0 Kg

CREPERAS · GOFRERA

· Semiprofessional use ·

Placa de aluminio antiadherente de Ø30 cm
Non-stick aluminium plate Ø30 cm



Inox · Professional use ·

Placa crepera

Plaque crêpière
Crêpes-Kochplatte
Crepe maker
Placa crepeira

Ref	€	W	U.Venta
69196	420.81	3000	1



Crea crepes dulces y salados, pancakes y tortitas de una manera sencilla y cómoda.

Rapidez, potencia y un calentamiento uniforme.

Placa de aluminio antiadherente de Ø30 cm, perfecta para hacer crepes de gran tamaño.

Incluye rastrillo de madera para extender la masa y conseguir un grosor homogéneo y espátula para voltear el crepe.

Faites des crêpes sucrées et salées, des pancakes et des petites galettes de façon simple et pratique.

Rapidité, puissance et une chauffe uniforme.

Plaque en aluminium antiadhésive de Ø30 cm, parfaite pour faire de grandes crêpes.

Inclut râtelier en bois pour étaler la pâte et obtenir une épaisseur homogène, et une spatule pour retourner la crêpe.

Placa de aluminio antiadherente de Ø30 cm
Non-stick aluminium plate Ø30 cm

Incluye rastrillo y espátula de madera
Includes a wooden scraper and spatula



Crepera BLACK

Crêpière
Crêpesplatte
Crepe maker
Crepeira

Ref	€	W	U.Venta
69122	46.07	1000	1

Süße und salzige Crêpes, Pancakes und Bütenen auf einfache und bequeme Weise zubereiten.

Schnelligkeit und Leistung bei gleichmäßiger Wärmeverteilung.

Anti-Haftbeschichtung aus Aluminium mit Ø30 cm, perfekt für große Crêpes.

Inklusive Holzspachtel, um den Teig zu verteilen und eine gleichmäßige Dicke zu erzielen, und Kelle, um die Crêpes zu wenden.

Make sweet and savoury crêpes, pancakes and pikelets easily and conveniently.

Speed, power and uniform heating.

Non-stick aluminium plate Ø30 cm, perfect for making large crêpes.

Includes a wooden scraper for spreading the batter to achieve uniform thickness and a spatula to flip the crêpe.

Para fazer crepes doces e salgados, panquecas e tortitas de maneira fácil e cómoda.

Rapidez, potência e aquecimento uniforme.

Placa de alumínio antiaderente de Ø30 cm, ideal para fazer crepes de tamanho grande.

Inclui utensílio de madeira para espalhar a massa e conseguir uma espessura homogênea, e uma espátula para virar os crepes.

Incluye rastrillo y espátula de madera
Includes a wooden scraper and spatula

Placa de aluminio antiadherente de Ø30 cm
Non-stick aluminium plate Ø30 cm



Crepera WHITE

Crêpière
Crêpesplatte
Crepe maker
Crepeira

Ref	€	W	U.Venta
69222	63.50	1000	1

Ref	Tensión/Voltage	Potencia/Power	Temperatura/Temp.	Placa/Grill	Dimensiones/Sizes	Peso/Weight
69196	220-240 V, 50/60 Hz	3000 W	60 °C - 250 °C	35 cm	45x49x22,5 cm	2,3 Kg
69122	220-240 V, 50/60 Hz	1000 W	200 °C (max)	Ø30 cm	40x36x11 cm	2,12 Kg
69222	220-240 V, 50/60 Hz	1000 W	240 °C (max)	Ø30 cm	40x38x8 cm	1,72 Kg



Inox
18/10

Gofres
Gaufrier
Wandwaffleisen
Waffle maker
Maquina de fazer gofres

Ref	€	W	U.Venta
69349	260,83	1000	1



Ø18 cm del gofre
Waffle Ø18 cm



Fabricada en acero inoxidable de la máxima calidad.
Placas de calentamiento con recubrimiento antiadherente.
Rápida de calentar, alcanza fácilmente la temperatura máxima de 300°C.
Obtendrás gofres crujientes de forma sencilla y rápida.

Fabricado en acier inoxydable de la plus grande qualité.
Plaques de chauffe avec revêtement anti adhésif.
Rapide à chauffer, il atteint facilement la température maximale de 300°C.
Vous obtiendrez des gaufres croustillants de façon simple et rapide.

Aus hochwertigem, rostfreiem Stahl hergestellt.
Heizplatten mit Antihaftbeschichtung.
Schnelle Erhitzung, erreicht schnell die maximale Temperatur von 300 °C.
Zur schnellen und einfachen Zubereitung von knusprigen Waffeln.

Made in top quality stainless steel.
Heating griddle with non-stick coating.
Fast heating, easily reaching maximum temperatures of 300°C.
Make crunchy waffles easily and quickly.

Fabricada em aço inoxidável da melhor qualidade.
Placas de aquecimento com revestimento antiaderente.
Aquece rapidamente, alcançando facilmente a temperatura máxima de 300 °C.
Para conseguir gofres estaladiços de forma simples e rápida.

Ref	Tensión/Voltage	Potencia/Power	Temperat./Temp.	Tiempo/Timer	Placa Gofre/Waffle plate	Dimensiones/Sizes	Peso/Weight
69349	220-240 V; 50/60 Hz	1000 W	50°C - 300°C	5 min.	Ø18 cm	26x44x26 cm	7 Kg

Prepara fácilmente coberturas para sus postres.
Puede añadirle especias (canela, jengibre en polvo, pimientas, vainilla) para un chocolate más intenso.

Easily prepare toppings for your desserts.
You can add spices (cinnamon, ginger powder, peppers, vanilla) for a more intense chocolate.



Inox
18/10

Baño María chocolate
Bain Marie de chocolat
Bain Marie topf für Schokolade
Chocolate Bain Marie
Banho-Maria Chocolate

Ref	€	W	U.Venta
69317	35,59	70	1

Permite fundir chocolate y mantenerlo caliente.
It allows you to melt chocolate and keep it hot.

Household use



Inox
18/10

Fuente de chocolate
Fontaine chocolat
Schokoladen Fontäne
Chocolate fountain
Fonte chocolate

Ref	€	W	Torre/Tower	U.Venta
A 69318	52,60	35	18 cm	1
B 69319	87,88	80	38 cm	1

Ref	Tensión/Voltage	Potencia/Power	Temperatura/Temp.	Capacidad/Capacity	Torre/Tower	Dimensiones/Sizes	Peso/Weight
69317	220-240 V; 50/60 Hz	70 W	40°C - 50°C	1,00 L (max)	-	29x22x12 cm	0,875 Kg
69318	220-240 V; 50/60 Hz	35 W	40°C - 50°C	0,50 L (max)	18 cms (Height)	Ø16x30 cm	1,15 Kg
69319	220-240 V; 50/60 Hz	80 W	40°C - 50°C	1,80 L (max)	38 cms (Height)	Ø23x54,5 cm	2,05 Kg

▶ QUEMADOR

Professional use



Quegador redondo
Fer à caraméliser rond
Brenner, rund
Round caramelizer
Queimador redondo

Ref	€	W	U.Venta
68651	98,67	650	1
68652	113,92	1000	1

Ref	Tensión/Voltage	Potencia/Power	Dimensiones/Sizes	Peso/Weight
68651	220-240 V; 50/60 Hz	650 W	Ø10 cm	1.132 Kg
68652	220-240 V; 50/60 Hz	1000 W	Ø12 cm	1.268 Kg



Idéal para elaboraciones de cocina y repostería que requieran caramelizar de forma rápida y homogénea (crema catalana, crème brûlée, arroz con leche, etc.)
Deja una fina capa dorada y crujiente.
Fabricado en acero inoxidable con mango de plástico de excelente calidad.

Idéal pour des préparations de cuisine et de pâtisserie qui requièrent une caramélisation rapide et homogène (crème catalana, crème brûlée, riz au lait, etc.)
Laisse une fine couche dorée et croustillante.
Fabriqué en acier inoxydable avec une poignée en plastique d'excellente qualité.

Idéal für Küchengerichte und Desserts, die ein schnelles und homogenes Karamellisieren erfordern (Katalanische Sahne, Crème brûlée, Milchreis usw.)
Bildet einen dünnen und knusprigen Überzug.
Aus Edelstahl mit hochwertigem Kunststoffgriff.

Idéal for cooking and pastry making that requires quick and even caramelizing.
(Catalan cream, crème brûlée, rice pudding, etc.)
It leaves a thin golden and crunchy layer.
Made of stainless steel with excellent quality plastic handle.

Idéal para elaborações de cozinha e pastelaria, que necessitam uma caramelização rápida e homogénea (creme catalão, creme brûlée, pudim de arroz, etc.)
Cria uma capa fina dourada e estaladiça.
Feito de aço inoxidável com cabo de plástico de excelente qualidade.

▶ AERÓGRAFO CON COMPRESOR



New



Professional use

Aerógrafo con compresor
Aérographe avec compresseur
Airbrush Spritzpistole mit Kompressor
Airbrush with compressor
Aerógrafo com compressor

Ref	€	W	Presión	Caudal	U.Venta
69450	88,81	20	0 - 2 bar	0 - 10 L/min	1

Ref	Tensión Voltage	Potencia Power	Presión Pressure	Caudal air Air flow	Capacidad Capacity	Long. tubo aire Air tube length	Aerógrafo Airbrush	Med. compresor Compressor size	Peso Weight
69450	220-240 V; 50/60 Hz	20 W	0 - 2 bar	0 - 10 L/min	7 ml	1,80 m	14,2x2,5x9	11,5x13,5x6 cm	800 g

Permite obtener detalles únicos en creaciones artísticas de repostería.
Aerógrafo por gravedad de doble acción con aguja de salida de 0,3 mm.
Incluye una caja acolchada para almacenar el aerógrafo.

Let's you get unique details on artistic bakery creations.
Double action gravity feed airbrush with a 0.3 mm needle.
Includes a padded box for storing the airbrush.



Tubo conector (1,8 m)
Manguera textil flexible con dos conexiones que traslada el aire del compresor al aerógrafo.
Flexible cloth hose with two connections that carries air from the compressor to the airbrush.

Aerógrafo
Genera un fino chorro de pintura para recubrir superficies o realizar dibujos mediante la palanca.
Deposito de 7 ml.
Creates a fine spray of paint for covering surfaces or making drawings by lever.
7 ml tank.

PLACAS CALENTAMIENTO

Professional use



Calentador BUFFET 3x GN 1/3

Chauffé
Warmer
Warmer
Aquecedor

Ref.	€	W	U.Venta
69445	84,87	300	1



Placa calentamiento

Plaque pour Chauffante
Warmhalteplatte
Warming Plate
Placa aquecimento

Ref.	€	W	U.Venta
69045	80,41	300	1



Placa calentamiento Vitrocerámica

Plaque vitrocéramique chaleur
Glaskeramikheizplatte
Hob heating plate
Placa aquecimento vitrocerâmica

Ref.	€	W	U.Venta
69145	177,83	230	1



Platos y bandejas siempre calientes

Ensures dishes and trays are always warm

Una solución perfecta para profesionales de hostelería, buffet, eventos, catering, ferias...

Ideal para mantener los alimentos calientes antes de servirlos en la mesa a una temperatura perfecta.

Termostato regulable en temperatura.

Tres contenedores de calentamiento GN 1/3 de 2,5 L con tapas transparentes de policarbonato, ideales para albergar una gran variedad de alimentos. Marco soporte de acero inoxidable (Ref.: 69445).

Puede usarlo como placa de calentamiento para calentar platos y preparados, quitando el soporte y los contenedores (Ref.: 69445).

NO cocinar sobre la misma placa.

Asas aislantes de calor y patas antideslizantes.

Une solution parfaite pour les professionnels de l'hôtellerie: buffets, événements, traiteurs, salons...

Idéale pour garder au chaud d'aliments avant de les servir à table à une température parfaite.

Thermostat réglable en température.

Trois conteneurs de réchauffage GN 1/3 de 2,5 L avec couvercles transparents en polycarbonate, parfaits pour accueillir une grande variété d'aliments. Cadre support en acier inoxydable (Ref.: 69445).

Peut être utilisé en tant que plaque pour réchauffer des plats et des préparations culinaires, en retirant le support et les conteneurs (Ref.: 69445).

NE PAS cuisiner sur la même plaque.

Poignées isolantes de la chaleur et pieds antidérapants.

Die perfekte Lösung für Gastgewerbe, Buffets, Veranlassungen, Catering, Messen... Ideal zum Warmhalten von Speisen, bevor sie bei perfekter Temperatur am Tisch serviert werden.

Thermostat mit Temperaturregelung.

Drei Heizbehälter GN 1/3 mit einem Volumen von 2,5 l und durchsichtigen Polycarbonat Decke, ideal zum Aufbewahren vielfältiger Lebensmittel.

Tragrahmen aus Edelstahl (Ref.: 69445).

Kann bei Enternen des Halters und der Behälter als Heizplatte zum Erwärmen von Speisen und Fertiggerichten verwendet werden (Ref.: 69445).

NICHT direkt auf der Platte kochen.

Isolierte Griffe und rutschfeste Füße.

A perfect solution for hospitality, buffet, events, catering and trade show professionals.

Ideal for keeping the food warm before serving them at a perfect temperature.

Temperature-adjustable thermostat.

Three GN 1/3 2.5 L heating containers with transparent polycarbonate lids, perfect for storing a wide variety of food. Stainless steel support frame (Ref.: 69445).

It can be used as a heating plate to warm up food or prepared dishes if the support and the containers are taken off (Ref.: 69445).

DO NOT cook on the same tray.

Heat-insulating handles and non-slip feet.

Uma solução perfeita para profissionas da hotelearia, buffets, eventos, catering, ferias...

Idéal para manter quentes os alimentos, para os servir à mesa a uma temperatura perfeita.

Termostato de temperatura regulável.

Três recipientes de aquecimento GN 1/3 de 2,5 litros, com tampas transparentes de policarbonato, ideais para armazenar uma grande variedade de alimentos. Marco de suporte em aço inoxidável (Ref.: 69445).

Pode utilizar-se como placa de aquecimento para aquecer pratos e preparados, retirando o suporte e os recipientes (Ref.: 69445).

NÃO cozinhar na própria placa.

Asas isoladoras do calor e patas antideslizantes.

Ref.	Tensión/Voltage	Potencia/Power	Contenedor/Container	Temp. máx./ Max. temp.	Placa/Plate	Dimensiones/Sizes	Peso/Weight
69445	220-240 V; 50/60 Hz	300 W	GN 1/3 - 2.5 L (3)	80°C (max)	53x35,8 cm	65x38x15,4 cm	4,20 Kg
69045	220-240 V; 50/60 Hz	300 W	-	80°C (max)	53x35,5 cm	65x38x6,2 cm	2,60 Kg
69145	220-240 V; 50/60 Hz	230 W	-	105°C (max)	55x36,5 cm	62x36,5x4,5 cm	4,10 Kg

▶ CALENTADOR BUFFET

Professional use



Ideal para grandes cocinas, buffet, catering o comedores.
Mantiene los platos a temperatura perfecta durante un tiempo prolongado.
Estructura de acero inoxidable de alta calidad y resistente.
Placa calentadora de acero inoxidable con regulación de temperatura entre 40°C - 90°C.
Lámparas halógenas para garantizar una temperatura homogénea con regulación independiente para cada una de ellas.
Pantalla protectora de plexiglas altamente resistente.

Idéal pour grandes cuisines, buffets, traiteurs ou cantines.
Maintient les plats à la température parfaite pendant un laps de temps prolongé.
Structure en acier inoxydable de grande qualité et résistante.
Plaque chauffante en acier inoxydable avec réglage de température de 40°C à 90°C.
Ampoules halogènes pour garantir une température homogène avec réglage indépendant pour chacune d'entre elles.
Écran de protection en plexiglas hautement résistant.

Ideal für Großküchen, Buffets, Catering oder Restaurants.
Hält Speisen über längere Zeit auf perfekter Temperatur.
Aus hochwertigem und widerstandsfähigem Edelstahl hergestellter Aufbau.
Heizplatte aus Edelstahl mit Temperaturregung zwischen 40°C bis 90°C.
Individuell einstellbare Halogenlampen sorgen für gleich bleibende Temperatur.
Schutzschirm aus hoch widerstandsfähigem Plexiglas.

Perfect for large kitchens, buffets, catering or dining rooms.
It keeps food at the perfect temperature for an extended period.
Durable high quality stainless steel structure.
Stainless steel heating plate with adjustable temperature from 40° C to 90° C.
The halogen lamps guarantee even temperature and each one can be adjusted independently.
High impact perspex safety screen.

Ideal para cozinhas grandes, buffets, catering e refeições.
Mantém os pratos a temperatura perfeita durante um tempo prolongado.
Estrutura de aço inoxidável de alta qualidade e resistente.
Placa aquecedora em aço inoxidável com regulação de temperatura entre 40 - 90 °C.
Lâmpadas de halógeno para garantir uma temperatura homogênea, com regulação individual e independente.
Placa protetora de metacrilato, altamente resistente.



Incluye bombillas infrarrojos (Ref.: R69061A)
Includes infrared heating bulbs



Calentador BUFFET DUAL

Plaque électrique
 Warmhalteplatte
 Electric warming plate
 Placa aquecimento elétrico

Ref	€	W (Placa)	W (Lámp.)	U.Venta
69562	442,29	500	2 x 250	1



Calentador BUFFET TRIPLE

Plaque électrique
 Warmhalteplatte
 Electric warming plate
 Placa aquecimento elétrico

Ref	€	W (Placa)	W (Lámp.)	U.Venta
69563	582,87	650	3 x 250	1

Ref	Tensión/Voltage	Pot. Placa/Plate P.	N° Lámp./Lamps	Pot. Lámp./Lamp P.	Temperatura/Temp.	Dimensiones/Sizes	Peso/Weight
69562	220-240 V; 50/60 Hz	500 W	2	250 W	40°C - 90°C	78x53x70 cm	12,5 Kg
69563	220-240 V; 50/60 Hz	650 W	3	250 W	40°C - 90°C	107x53x70 cm	16,5 Kg

▶ LÁMPARAS CALENTAMIENTO

Professional use

Apta para todas nuestras lámparas de calentamiento
Suitable for all our heating lamps

Bombilla infrarrojos

Ampoule infrarouge
Infrarot Glühbirne
Infrared heating bulb
Lampada infravermelho

Ref	€	W	U.Venta
R69061A	8,40	275	1



Para uso profesional en hostelería.

Mantiene calientes los platos. Calentamiento por infrarrojos.
Se aconseja mantener la lámpara a 50 - 60 cm de distancia de los platos.
Bombilla para todas nuestras lámparas de calentamiento.

Pour un usage professionnel en hôtellerie.

Maintient les plats au chaud. Chauffage par infrarouges.
Il est conseillé de maintenir la lampe à une distance de 50 - 60 cm des plats.
Ampoule pour toutes nos lampes chauffantes.

Für den Einsatz im Gastronomiebereich.

Hält die Speisen warm. Erwärmung durch Infrarotstrahlen.
Es wird empfohlen, einen Abstand von 50 bis 60 cm zwischen der Lampe und den Speisen einzuhalten.
Glühbirne für alle unsere Heizlampen.

For professional catering use.

Hält die Speisen warm. Infrared heating.
It is recommended that the lamp is kept at a distance of 50-60cm from the plates.
Bulb for all our heating lamps.

Para uso profissional em hotelaria.

Mantém os pratos quentes. Aquecimento por infravermelhos.
É recomendável manter as lâmpadas a uma distância de 50 a 60 cm dos pratos.
Bulbo para todas as nossas lâmpadas de aquecimento.

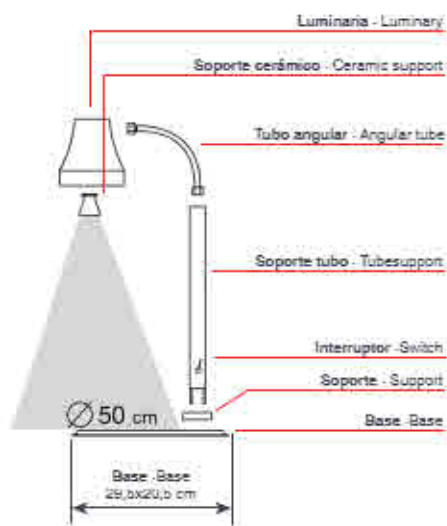

Incluye bombillas infrarrojos (Ref.: R69061A)
Includes infrared heating bulbs



AL
Aluminium

Lámpara calentamiento infrarrojos

Lampe de chauffage infrarouge
Infrarot Wärmelampe
Infrared heating lamp
Lampara calor infravermelho

	Ref	€	W	U.Venta
A	69361	90,37	275	1
B	69061	125,12	550	1



Regulable en altura
Height adjustable



Inox
18/10

Lámpara de calentamiento infrarrojos

Lampe de chauffage infrarouge
Infrarot Wärmelampe
Infrared heating lamp
Lampara calor infravermelho

	Ref	€	W	U.Venta
A	69263	407,32	275	1
B	69264	529,44	550	1

Ref	Tensión/Voltage	Potencia/Power	Dimensiones/Sizes	Peso/Weight
69361	220-240 V; 50/60 Hz	275 W	34x33x56 - 71 cm	1,15 Kg
69061	220-240 V; 50/60 Hz	550 W	36x45x61 - 75 cm	1,58 Kg
69263	220-240 V; 50/60 Hz	275 W	79x31x23 cm	6,0 Kg
69264	220-240 V; 50/60 Hz	550 W	76x36x36 cm	7,0 Kg

▶ LÁMPARAS CALENTAMIENTO EXTENSIBLES Professional use

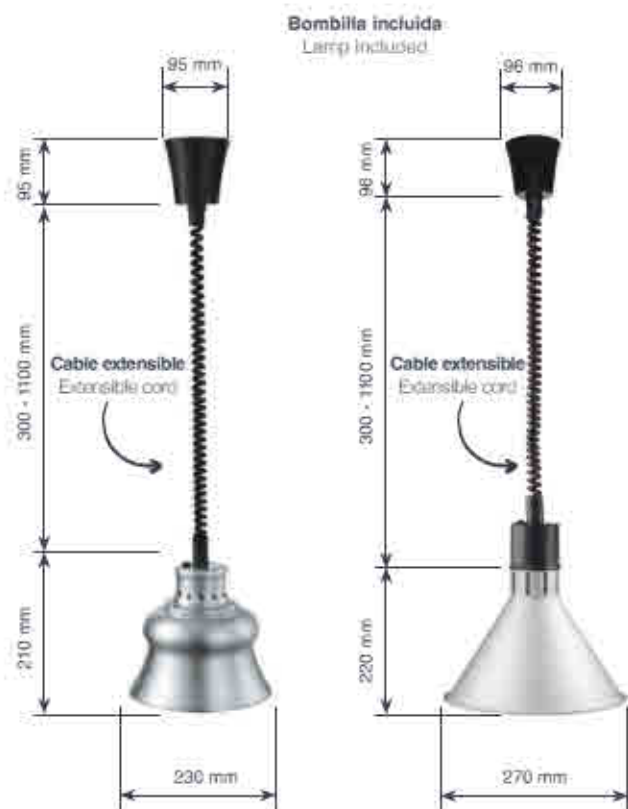

Para uso profesional en hostelería.
Mantiene calientes los platos. Calentamiento por infrarrojos.
Se aconseja mantener la lámpara a 50 - 60 cm de distancia de los platos.
Bombilla para todas nuestras lámparas de calentamiento.

Pour un usage professionnel en hôtellerie
Maintient les plats au chaud. Chauffage par infrarouges.
Il est conseillé de maintenir la lampe à une distance de 50 - 60 cm des plats.
Ampoule pour toutes nos lampes chauffantes.

Für den Einsatz im Gastronomiebereich.
Hält die Speisen warm. Erwärmung durch Infrarotstrahlung.
Es wird empfohlen, einen Abstand von 50 bis 60 cm zwischen der Lampe und den Speisen einzuhalten.
Glühbirne für alle unsere Heizlampen.

For professional catering use.
Keeps the dishes warm. Infrared heating.
It is recommended that the lamp is kept at a distance of 50-60cm from the plates.
Bulb for all our heating lamps.

Para uso profissional em horelaria
Mantém os pratos quentes. Aquecimento por infravermelhos.
É recomendável manter as lâmpadas a uma distância de 50 a 60 cm dos pratos.
Bulbo para todas as nossas lâmpadas de aquecimento.



Incluye bombillas infrarrojos (Ref.: R69061A)
Includes infrared heating bulbs



Lámpara de calentamiento infrarrojos cable extensible

Lampe de chauffage infrarouge câble extensible
Infrarot Wärmelampe Kabel ausziehbar
Infrared heating lamp extensible
Lâmpara calor infravermelho cabo extensível

	Ref	€	W	U.Venta	
A	69266	103,23	275	1	Lijado - Sanding
B	69365	118,69	275	1	Cromado - Chrome
C	69367	118,69	275	1	Cobre - Copper



Lámpara de calentamiento extensible cónica

Lampe chauffante extensible conique
Wärmelampe Kabel ausziehbar, konisch
Conical heating lamp extensible
Lâmpada de aquecimento ext. cônica

	Ref	€	W	U.Venta	
A	69564	106,97	275	1	Lijado - Sanding
B	69566	128,34	275	1	Cromado - Chrome
C	69565	130,52	275	1	Cobre - Copper

Ref	Tensión/Voltage	Potencia/Power	Dist. lámp. platos Lamp food distance	Peso/Weight
69266	220-240 V, 50/60 Hz	275 W	50 - 60 cm	2,00 Kg
69365	220-240 V, 50/60 Hz	275 W	50 - 60 cm	2,00 Kg
69367	220-240 V, 50/60 Hz	275 W	50 - 60 cm	2,00 Kg
69564	220-240 V, 50/60 Hz	275 W	50 - 60 cm	1,60 Kg
69566	220-240 V, 50/60 Hz	275 W	50 - 60 cm	1,60 Kg
69565	220-240 V, 50/60 Hz	275 W	50 - 60 cm	1,60 Kg



Mantiene caliente todo tipo de sopas, salsas, consomés y líquidos. Ideal para cantidades grandes.

Maintenir au chaud tout type de soupes, sauces, consommés, liquides, etc. Idéal pour de grandes quantités.

Warmhalten aller Arten von Suppen, Saucen, Konsommés, Flüssigkeiten, usw. Ideal für große Mengen.

Keep all kinds of soups, sauces, consommés, liquids etc hot. Ideal for large amounts.

Manter quente todo o tipo de sopas, molhos, consomés, líquidos, etc. Ideal para grandes quantidades.

Inox
18/10

Calentador de sopa

Chaufte-soupe
Suppenwärmer
Soup heater
Aquecedor de sopa



Ref	€	W	U.Venta
69257	254,08	800	1

Olla calentador sopa

Marrite Buffet chaud
Suppen- und Speisenwärmer
Soup kettle
Panela aquecedora de sopa



Ref	€	W	U.Venta	
69037	149,51	400-475	1	Hierro esmaltado
69038	214,87	400-475	1	Inox



Inox

Contenedor sopa Inox 10 L

Bac pour soup en inox
Behälter für elektrischen Wärmer
St. Steel soup container
Recipiente sopa Inox 10 L



Ref	€	Ø (cm)	L
69039	50,01	24x25	10

Ref	Tensión/Voltage	Potencia/Power	Temperatura/Temp.	Capacidad/Capacity	Dimensiones/Sizes	Peso/Weight
69267	220-240 V; 50/60 Hz	800 W	30°C - 90°C	11,0 L	Ø33x32 cm	4,50 Kg
69037	220-240 V; 50/60 Hz	400 - 475 W	30°C - 90°C	10,0 L	Ø34,5x36 cm	4,50 Kg
69038	220-240 V; 50/60 Hz	400 - 475 W	30°C - 90°C	10,0 L	Ø34,5x36 cm	4,50 Kg

Combinaciones de cubetas posibles

Possible tray options

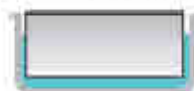
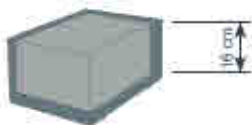

1 x GN 1/1 - 150

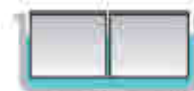

2 x GN 1/2 - 150



3 x GN 1/3 - 150

Inox
18/10

Baño María GN 1/1 150 mm

Bain-marie en inox GN 1/1 150 mm
Bain Marie, GN 1/1 150 mm, Rostfrei
St. Steel bain-marie GN 1/1 150 mm
Banho-maria GN 1/1 150 mm

Ref	€	W	U.Venta
69036	200,85	1300	1



Ref	Tensión/Voltage	Potencia/Power	Temperatura/Temp.	Capacidad/Capacity	Dimensiones/Sizes	Peso/Weight
69036	230 V; 50 Hz	1300 W	85°C	24 L	61,5x39x30 cm	8,50 Kg

▶ CHAFING DISH ELÉCTRICO

Professional use



Ideal para el sector de la hostelería, restauración y catering.
Mantiene la temperatura de los alimentos.
Más seguro al carecer de flama de los gases.
Tapa y cubeta extraíble GN 1/1 H=65 mm (8,50 L) fabricados en acero inoxidable de alta calidad. Cuerpo fabricado en polipropileno.
Termostato regulable (85°C +/-10°C).
Interruptor de encendido y apagado. Indicador luminoso.
Protección contra sobrecalentamiento.
Fácil de transportar gracias a sus asas laterales.
6 pies antideslizantes y resistentes para mantener la estabilidad.

Parfait pour le secteur hôtelier, la restauration et le traiteur.
Conserve la température des aliments.
Plus sûr parce qu'il n'y a pas de flammes des gazs.
Couvercle et bac amovible GN 1/1 H=65 mm (8,50 L) en acier inoxydable de haute qualité. Corps fabriqué en polypropylène.
Thermostat réglable (85 °C +/- 10 °C).
Interrupteur marche/arrêt. Indicateur lumineux.
Protection contre les surchauffes.
Facile à transporter grâce à ses poignées latérales.
6 pieds antidérapants et résistants pour maintenir la stabilité.

Ideal für Hotel- und Gaststättengewerbe und Catering.
Temperatur der Nahrungsmittel bleibt erhalten.
Sicherer ohne Brennpaste/Brenngas.
Abnehmbarer Deckel und Speiseinsatz aus hochwertigem Edelstahl (GN 1/1 H=65 mm (8,50 l)). Mit Gestell aus Polypropylen.
Einstellbares Thermostat (85 °C +/- 10 °C).
Mit Ein- und Ausschalter. Kontrollleuchte.
Schutz vor Überhitzung.
Einfach an Seitengriffen zu tragen.
6 widerstandsfähige Anti-Rutschfüße für festen Stand.

Ideal for the hospitality, restaurant and catering sectors.
Maintains temperature of food.
Safer than chafing dishes that use gas heats.
Removable lid and tray GN 1/1 H=65 mm (8,5 L) manufactured in high-quality stainless steel. Body manufactured in polypropylene.
Adjustable thermostat (85°C +/-10°C).
On / Off switch. Light indicator.
Overheating protection.
Easily portable using the side handles.
6 non-slip resistant bases to ensure stability.

Ideal para o setor da hotelaria, restauração e catering.
Mantém a temperatura dos alimentos.
Mais seguro, ao não utilizar gases com chama.
Tampa e cubeta extraível de aço GN 1/1 H= 65 mm (8,50 L) de aço inoxidável de alta qualidade. Corpo fabricado em polipropileno.
Termostato regulável (85°C +/-10°C).
Interruptor de ligar/desligar. Indicador luminoso.
Proteção contra sobreaquecimento.
Fácil de transportar, graças às suas asas laterais.
6 patas antideslizantes e resistentes, para maior estabilidade.

Cubeta GN 1/1 en Inox (H=65 mm / 8,50 L)
GN 1/1 st steel container (H=65 mm / 8,5 L)

Tapa y cubeta en inox
Stainless steel lid and bucket



Combinaciones de cubetas posibles - Possible tray options



Chafing Dish
 Chafing Dish
 Chafing Dish
 Chafing Dish
 Chafing Dish

Ref	€	W	U. Venta
69336	153,79	900	1

Ref	Tensión/Voltage	Potencia/Power	Capacidad/Capacity	Temperatura/Temp.	Cubeta/Container	Dimensiones/Sizes	Peso/Weight
69336	220-240 V; 50/60 Hz	900 W	8,50 L	85°C (+/-10°C)	1GN 1/1 H=65 mm	55x34,5x25 cm	3,90 Kg

▶ CALENTADORES CHAFING DISH

Professional use



Calentador para Chafing

Corp de chauffe pour bain marie
Heizung für Chafing Dish
Heating unit for chafing dish
Aquecedor para chafing dish

Ref	€	W	U.Venta
A 69002	159.67	700	1
B 69012	184.68	700	1

Con regulador - With regulator

A 96°C
max



B 92°C
max



Ref	Tensión/Voltage	Potencia/Power	Temp./Temp.	Dimensiones/Sizes	Adapt.
69002	220-240 V; 50/60 Hz	700 W	96°C (max)	25x20 cm	69015-69000
69012	220-240 V; 50/60 Hz	700 W	92°C (max)	25x20 cm	69001-69004 69110

▶ AIRPOT

Professional use



Fácil sist. de apertura
Easy open system



Nivel de indicador de líquido
Liquor level indicator



Sist. dispensador cómodo
Convenient dispensing system



Sensor de temperatura
Temperature sensor



Marcas de llenado
Fill lines



Posibilidad de graduar la temperatura
The temperature can be adjusted

Ideal para agua, café y té
Perfect for water, coffee and tea

Fabricado en acero inoxidable resistente y de alta calidad.
Dispone de un grifo dispensador con indicador de nivel de líquido.
Temperatura controlada por termostato con un rango de 60°C a 100°C.
Dispone de asas laterales aislantes de la calor para un desplazamiento seguro.
NO USAR CON LÁCTEOS por la posible contaminación, debido a restos fermentados.

Fabriqué en acier inoxydable résistant et de grande qualité.
Dispose d'un robinet de distribution avec indicateur du niveau de liquide.
Température contrôlée par thermostat dans une tranche de 60°C à 100°C.
Dispose de poignées latérales isolantes de la chaleur pour un déplacement sûr.
NE PAS UTILISER DES PRODUITS LAITIERS en raison de l'éventuelle contamination due aux restes fermentés.

Aus widerstandsfähigem, hochwertigem Edelstahl hergestellt.
Verfügt über einen Spenderhahn mit Flüssigkeitsstandsanzeige.
Temperaturregelung mithilfe eines Thermostats zwischen 60 und 100 °C.
Mit seitlichen, wärmeisolierten Griffen für einen sicheren Transport.
Von der VERWENDUNG VON MILCHPRODUKTEN wird wegen möglicher vorhandener vorgeräter Resse ABGERATEN.

Made of strong high quality stainless steel.
Includes a spigot with a level indicator.
Temperature controlled by a thermostat with a range from 60° C to 100° C.
Side mounted insulated handles for safe moving.
DO NOT USE WITH DAIRY PRODUCTS due to possible contamination from fermented residues.

Fabricado em aço inoxidável resistente e de alta qualidade.
Com torneira dispensadora com indicador de nível do líquido.
Temperatura controlada por termostato regulável de 60 a 100° C.
Dispõe de asas laterais isoladoras do calor para uma deslocação segura.
NÃO UTILIZAR COM LACTEÓS pela possível contaminação devido à existência de restos fermentados.



Airpot

Airpot
Getränkenspender
Airpot
Airpot

Ref	€	L	U.Venta
69472	113.81	4	1
69476	122.94	6	1
69471	134.25	10	1



Ref	Tensión/Voltage	Potencia/Power	Capacidad/Capacity	Temperatura/Temp.	Dimensiones/Sizes	Peso/Weight
69472	220-240 V; 50/60 Hz	1500 W	4 L	60°C - 100°C	28x28x35 cm	1,90 Kg
69476	220-240 V; 50/60 Hz	1500 W	6 L	60°C - 100°C	28x28x40 cm	2,00 Kg
69471	220-240 V; 50/60 Hz	1500 W	10 L	60°C - 100°C	28x28x48 cm	2,20 Kg

▶ DISPENSADOR DE AGUA CALENTE INSTANT

Semiprofessional use



Ideal para oficinas, casas rurales, reuniones, etc.
Fácil llenado. Depósito extraíble de gran capacidad (2L) para llenar fácilmente el contenedor.
Display intuitivo. Elige la cantidad de agua (150 ml - 230 ml- 300 ml) y la temperatura deseada (25°C - 70°C - 85°C - 95°C).
Cuenta con función de bloqueo de seguridad.
Ahorra tiempo y energía. Proporciona la cantidad exacta de agua caliente deseada, el agua restante del depósito se mantendrá fría.
Bandeja de goteo extraíble e imantada, fácil de limpiar y colocar.

Idéal pour les bureaux, les gîtes ruraux, les réunions, etc.
Remplissage facile. Réservoir extractible de grande capacité (2L) pour remplir facilement le conteneur.
Écran intuitif. Choisissez la quantité d'eau (150 ml - 230 ml- 300 ml) et la température souhaitée (25°C - 70°C - 85°C - 95°C).
Dispose d'une fonction de blocage de sécurité.
Gain de temps et économies d'énergie. Fournit la quantité exacte d'eau chaude souhaitée, l'eau restant dans le réservoir restera froide.
Plateau d'écoulement extractible et aimanté, facile à nettoyer et à installer.

Idéal für Büros, Landhäuser, Sitzungen usw.
Einfaches Füllen. Herausnehmbare Tank mit großem Fassungsvermögen (2L) zum einfachen Füllen des Behälters.
Intuitives Display. Wassermenge (150 ml - 230 ml- 300 ml) und erwünschte Temperatur (25°C - 70°C - 85°C - 95°C) wählbar.
Mit Sicherheitsperre.
Spart Zeit und Energie. Spendet genau die erwünschte Menge heißes Wasser, im Tank blühendes Wasser bleibt kalt.
Herausnehmbare und magnetische Tropfwanne, einfach zu reinigen und anzubringen.

Perfect for offices, country homes, meetings, etc.
Easy to fill. Large capacity (2L) removable tank to easily fill the container.
Intuitive display. Choose the amount of water (150 ml - 230 ml- 300 ml) and the desired temperature (25°C - 70°C - 85°C - 95°C).
Includes safety lock feature.
Saves time and energy. Provides the exact amount of hot water desired, while the remaining water in the tank remains cold.
Removable and magnetic drip tray, easy to clean and replace.

Idéal para escritórios, casas de turismo rural, reuniões, etc.
Fácil de encher. Depósito extraível de grande capacidade (2L) para encher facilmente o recipiente.
Ecra intuitivo. Selecione a quantidade de água (150/230/300 ml) e a temperatura desejada (25/70/85/95 °C).
Função de bloqueio de segurança.
Poupa tempo e energia. Proporciona a quantidade exata de água quente desejada; a água restante do depósito mantém-se a frio.
Bandeja de gotejamento extraível e magnética, fácil de limpar e de colocar.

Display intuitivo
Intuitive display

Bandeja de goteo extraíble e imantada
Removable and magnetic drip tray



Agua caliente en 5 segundos
Hot water in 5 seconds



Dispensador de agua caliente

Distributeur d'eau chaude
Heißwasserspender
Hot water dispenser
Dispensador de água quente

Ref	€	W	L	U.Venta
69298	105,20	2400	2,0	1

Ref	Tensión/Voltage	Potencia/Power	Capacidad/Cap.	Niveles Calentamiento/Heating levels	Dispensado agua/Water dispensed	Dimensiones/Sizes	Peso/Weight
69298	220-240 V, 50/60 Hz	2400 W	2,00 L	25°C - 70°C - 85°C - 95°C	150-230-300 ml	32x18,8x32,7 cm	2,50 Kg

▶ HERVIDORES DE AGUA

- Household use -

New

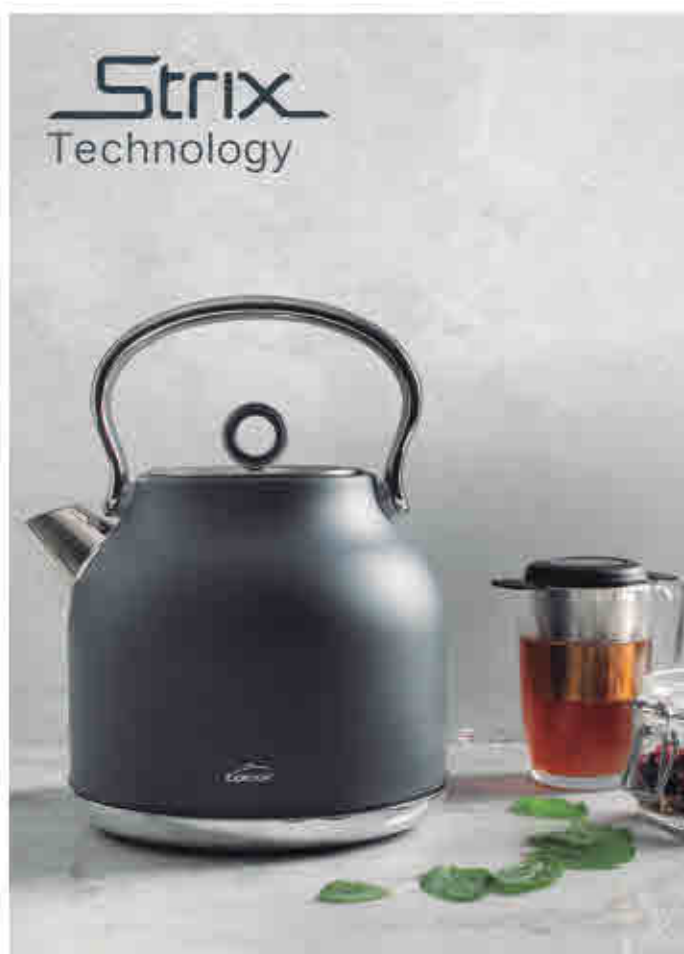

Strix
Technology



Hervidor de agua Retro fabricado en acero inoxidable 18/10, acabado en gris mate. Permite calentar el agua de manera rápida y eficiente. Botón luminoso de encendido/apagado. Base independiente rotativa de 360°. Control STRIX, vida útil superior al controlador estándar. Protección contra el calentamiento en vacío muy preciso. Apagado automático. Visor de nivel de agua. Boquilla con filtro. Mango termo resistente.

Bouilloire Retro fabriquée en acier inoxydable 18/10, finition gris mat. Permet de chauffer l'eau de façon rapide et efficace. Bouton lumineux de marche/arrêt. Base indépendante rotative à 360°. Contrôle STRIX, durée de vie utile supérieure au contrôleur standard. Protection contre la chauffe à vide très précise. Arrêt automatique. Visualisation du niveau d'eau. Buse avec filtre. Poignée thermo-résistante.

Retro Wasserkocher Material: Edelstahl 18/10. Farbe: Matgrau Erhitzt Wasser schnell und sparsam. Leuchtender Ein-/Ausschalter. Sockel als Einzelteil um 360° drehbar. STRIX Steuerung mit überdurchschnittlicher Lebensdauer. Äußerst zuverlässiger Leerlaufschutz. Abschaltautomatik. Wasserstandanzeige. Düse mit Filter. Griff hitzebeständig.

Retro kettle made of 18/10 stainless steel with a matte grey finish. It can be used to heat water quickly and efficiently. Illuminated on/off button. Independent base rotates 360°. STRIX controller: useful life longer than a standard controller. Very precise protection against heating while empty. Automatic Shut-off. Water level viewer. Nozzle with filter. Heat-resistant handle.

Fervedor de água Retro, fabricado em aço inoxidável 18/10, com acabamento cinzento mate. Permite aquecer a água de maneira rápida e eficiente. Botão luminoso de ligar/desligar. Base independente e rotativa de 360°. Controle STRIX, que proporciona uma vida útil superior à de um controlador standard. Proteção de grande precisão contra o aquecimento em vazio. Desconexão automática. Indicador de nível de água. Bocal com filtro. Asa termoresistente.

Permite calentar el agua de manera rápida y eficiente

It can be used to heat water quickly and efficiently



Hervidor de agua RETRO
Bouilloire électrique
Elektrische Wasserwamer
Electric kettle
Chaleira eléctrica

Ref	€	W	L	U.Venta
69397	50.11	2200	1.7	1



Base independiente rotativa de 360°
Independent base rotates 360°



Botón luminoso de encendido/apagado
Illuminated on/off button



Fácil llenado
Easy filling



Interior Inox 18/10
Calentamiento rápido
Interior 18/10 st. steel
Fast heating



Boquilla con filtro
Nozzle with filter



Indicador de nivel de agua
Water level indicator

Ref	Tensión/Voltage	Potencia/Power	Capacidad/Capacity	Dimensiones/Sizes	Peso/Weight
69397	220-240 V : 50/60 Hz	2200 W	1,70 L	26x19,5x26,5 cm	1,20 Kg



Filtro extraíble anti-cal
Removable anti-calc filter



Visor de nivel de agua
Water level



Base rotativa de 360°
360° rotating base



Calefactor oculto
Hidden heater

Apagado automático

Se desactiva cuando alcanza el nivel de temperatura deseada

Automatic shutdown

It is deactivated when it reaches the desired temperature level

Botón apertura tapa

Cover opening button



Hervidor de agua GREY

Bouilloire

Wasserwamer

Kettle

Chaleira

Ref	€	Color	w	L	U.Venta
69590	19.09	GREY	2200	1,30	1
69591	19.09	WHITE	2200	1,30	1

Ref	Tensión/Voltage	Potencia/Power	Capacidad/Capacity	Dimensiones/Sizes	Peso/Weight
69590	220-240 V; 50/60 Hz	2200 W	1,30 L	20x15x21 cm	0,740 Kg
69591	220-240 V; 50/60 Hz	2200 W	1,30 L	20x15x21 cm	0,740 Kg

Strix
Technology

Botón apertura tapa
Cover opening button



Botón apertura tapa
Cover opening button



Visor de nivel de agua
Water level



Inox
18/10

Hervidor de agua

Bouilloire

Wasserwamer

Kettle

Chaleira

Ref	€	W	L	U.Venta
69277	51.36	2200	1,70	1

Inox
18/10

Hervidor de agua

Bouilloire

Wasserwamer

Kettle

Chaleira

Ref	€	W	L	U.Venta
69291	34.24	1650	1,00	1
69297	42.75	2200	1,70	1

Ref	Tensión/Voltage	Potencia/Power	Capacidad/Capacity	Dimensiones/Sizes	Peso/Weight
69277	220-240 V; 50/60 Hz	2200 W	1,70 L (5 min)	23x18x23 cm	1,00 Kg
69291	220-240 V; 50/60 Hz	1650 W	1,00 L (3 min)	22x16x21 cm	1,10 Kg
69297	220-240 V; 50/60 Hz	2200 W	1,70 L (5 min)	22x18x23 cm	1,65 Kg



Base para conector de 360°. Se apagará automáticamente cuando el agua hierva. Elemento de calefacción oculto. Protección de ebullición en seco. Indicador de luz de encendido/apagado. La temperatura se puede ajustar de 50°C-95°C. Botón de apertura de la tapa del hervidor. Almacenamiento de cable.

Base pour connecteur de 360°. S'éteint automatiquement lorsque l'eau bout. Élément de chauffe caché. Protection d'ébullition à sec. Indicateur lumineux de marche / arrêt. La température peut être réglée entre 50°C et 95°C. Bouton d'ouverture du couvercle de la bouilloire. Rangement du câble.

Grundplatte für eine um 360° drehbare Verbindung. Schaltet sich automatisch ab, wenn das Wasser kocht. Verstecktes Heizelement. Schutz gegen Erhitzen in leerem Zustand. Leuchtanzeige an/aus. Die Temperatur kann zwischen 50°C und 95°C eingestellt werden. Knopf zum Öffnen des Deckels; kabelfaufnahme.

Base for 360° connector. The wireless boiler will automatically switch off when the water boils. Hidden heating element. Dry boil protection. ON/OFF light. The temperature can be adjusted from 50°C - 95°C. button for opening the boiler cap. Cable storage.

Base para conector de 360°. Desliga-se á automaticamente quando a água ferver. Elemento de aquecimento oculto. Proteção de ebullicão a seco. Indicador de luz de ligação/desligação. A temperatura pode ser ajustada de 50°C a 95°C. Botão de abertura da tampa do aquecedor. Armazenamento do cabo.

Inox | **Cristal**
18/10 | Glass

Hervidor de agua

Bouilloire
Wasserwamer
Kettle
Chaleira

Ref	€	W	L	U.Venta
69292	58,1€	2200	1,70	1

Ref	Tensión/Voltage	Potencia/Power	Temperatura/Temp.	Capacidad/Capacity	Dimensiones/Sizes	Peso/Weight
69292	220-240 V; 50 Hz	2200 W	50 - 95°C	1,70 L	23x23x32 cm	1,90 Kg



Tapa extraíble con cierre
Removable lid with closure



Indicador de capacidad máxima
Maximum capacity indicator



Tapa extraíble con cierre
Removable lid with closure



Indicador de capacidad máxima
Maximum capacity indicator



Interior Inox 18/10
Calentamiento rápido
Fast heating



Base independiente rotativa de 360°
Independent base, rotates 360°



Base independiente rotativa de 360°
Independent base, rotates 360°

New

CE
Ceramic

Hervidor de agua cerámico GALA

Bouilloire en céramique
Keramik Wasserwamer
Ceramic kettle
Chaleira cerâmica

Ref	€	W	L	U.Venta
69276	43,68	1500	1,20	1

CE
Ceramic

Hervidor cerámico eléct.GALA GREY

Bouilloire électrique en céramique
Keramik Elektrische Wasserwamer
Ceramic electric kettle
Chaleira eléctrica cerâmica

Ref	€	W	L	U.Venta
69289	47,73	1200	1,0	1

Ref	Tensión/Voltage	Potencia/Power	Capacidad/Capacity	Dimensiones/Sizes	Peso/Weight
69276	220-240 V; 50/60 Hz	1500 W	1,2 L	24x17x25 cm	1,68 Kg
69289	220-240 V; 50/60 Hz	1200 W	1,0 L	23x16,5x23 cm	1,40 Kg

▶ ESPUMADORES DE LECHE

Household use



Disfruta de una espuma fina y cremosa en pocos segundos.
 Capacidad espuma: 115 ml / Capac. calentamiento: 240 ml (69396) - 250 ml (69398).
 Tecnología magnética, el movimiento de los accesorios se crea por atracción (69398).
 Apagado automático.
 Base independiente rotativa de 360°, fácil de rellenar y verter.
 Funcionamiento silencioso.
 Indicador de luz que visualiza si la leche está caliente o fría.
 Apta para leches vegetales. Fácil de limpiar.

Obtenez une mousse fine et crémeuse en quelques secondes!
 Capacité de mousse: 115 ml / Capacité de chauffe: 240 ml (69396) - 250 ml (69398).
 Technologie magnétique, le mouvement des accessoires se crée par attraction (69398).
 Arrêt automatique.
 Base indépendante rotative de 360°, sans fil, facile à remplir et à verser.
 Fonctionnement silencieux.
 Indicateur lumineux qui indique si le lait est chaud ou froid.
 Apte pour les laits végétaux. Facile à nettoyer.

Genießen Sie Schaum in nur Sekunden gerusst bereit.
 Milchschaum: 115 ml / warme Milch: 240 ml (69396) - 250 ml (69398).
 Magnetechnik, Zubehör bewegen sich durch Anziehungskraft (69398).
 Abschaltautomatik.
 Die Basis ist um 360° drehbar, ohne Kabel, einfaches Ein- und Ausgießen.
 Geräuscharmer Lauf.
 Kontrollleuchte zeigt an, ob die Milch warm oder kalt ist.
 Pflanzenmilch geeignet. Leichte Reinigung.

Enjoy a fine, creamy foam in as little seconds.
 Frothing capacity: 115 ml / Heating capacity: 240 ml (69396) - 250 ml (69398).
 Magnetic technology: The movement of the accessories is created with attraction (69398).
 Automatic shut-off.
 360° rotating independent base, easy to fill and pour.
 Silent operation.
 The indicator light shows whether the milk is hot or cold.
 Suitable for plant milk and easy to clean.

Desfrute de uma espuma fina e cremosa em apenas unos segundos.
 Capacid. de espuma: 115 ml / Capacid. de aquecimento: 240 ml (69396) - 250 ml (69398).
 Tecnología magnética: o movimento dos acessórios gera-se pela atração (69398).
 Desconexão automática.
 Base independente rotativa de 360°, sem cabos, fácil de encher e de verter.
 Funcionamento silencioso.
 Indicador luminoso, que indica se o leite está quente ou frio.
 Apto para leites de origem vegetal. Fácil de limpar.



Calentar
Heat

3 in 1



Calentar y espumar. Espumar leche fría
Heat and froth. Froth cold milk



Espumador de leche
 Mousseur à lait
 Milchaufschäumer
 Milk frother
 Espumador de leite



New

Jarra de cristal
Glass jug



Espumador de leche MAGNETIC
 Mousseur à lait
 Milchaufschäumer
 Milk frother
 Espumador de leite



Ref	€	W	ml	U.Venta
69396	53,12	500	240	1

Ref	€	W	ml	U.Venta
69398	65,09	600	250	1

Ref	Tensión/Voltage	Potencia/Power	Cap. espuma/Cap. foam	Cap. leche/Cap. milk	Base/Base	Dimensiones/Sizes	Peso/Weight
69396	220-240 V, 50/60 Hz	500 W	115 ml	240 ml	360°	Ø10x21 cm	650 g
69398	220-240 V, 50/60 Hz	600 W	115 ml	250 ml	360°	11,8x11,8x19,5 cm	900 g

MOLINILLOS DE CAFÉ

- Household use -



69485

Disfruta de todo el aroma y sabor de un café recién molido.
 Embudo de 200g de capacidad con tapa.
 Fresa cónica de acero inoxidable, muele el café uniformemente,
 19 diferentes niveles de molido, se adapta a todo tipo de cafeteras y a la intensidad de sabor que se desee.
 Selector de tazas de 1 a 12 tazas, mantiene los granos frescos y evita el desperdicio del café.
 Contenedor transparente extraíble de 100 g. Libre de BPA.

Profitez de tout l'arôme et du goût du café fraîchement moulu.
 Entonnoir d'une capacité de 200 g avec couvercle.
 Une fraise conique en acier inoxydable, qui moule le café de manière régulière.
 19 niveaux de mouture différents, elle s'adapte à tous les types de machines à café et à l'intensité de goût souhaitée.
 Sélecteur de tasses de 1 à 12 tasses, il permet de conserver la fraîcheur des grains et d'éviter le gaspillage de café.
 Récipient transparent amovible de 100 g. Sans BPA.

Enjoy the taste and aroma of freshly ground coffee.
 Hopper with a capacity of 200 g with a lid.
 Conical stainless steel cutter to ensure the coffee is ground uniformly.
 19 different grind sizes to choose from, suitable for all types of coffee machines and for all flavour intensities.
 Choose between 1 and 12 cups to keep the coffee grounds fresh and avoid wasting coffee.
 Removable 100 g transparent container. BPA-free.

19 diferentes niveles de molienda. 19 different grind sizes



Fine	Número de tazas Number of cups	Tiempo de molido Grinding time	Coarse
	2	8 seg	
	4	12 seg	
	6	20 seg	
	8	24 seg	
	10	26 seg	
	12	30 seg	

Ideal para moler café y otros productos como semillas, hierbas, frutos secos, cereales, sal, pimienta, azúcar o especias.

Perfect for grinding coffee or other products like seeds, herbs, nuts, grains, salt, pepper, sugar or spices.



Cuchillas de acero inoxidable de gran resistencia
 High strength stainless steel blades



Molinillo Inox

Moulin en inox
 Mühle aus Edelstahl
 St steel grinder
 Moimho Inox

Ref	€	W	g	U.Venta
69385	32.27	200	60	1

New

Selector de tazas, de 1 a 12 tazas
 Cup selector: 1 to 12 cups



Molinillo de café KALDI

Moulin à café
 Kaffeemühle
 Coffee grinder
 Moedor de café

Ref	€	W	g	U.Venta
69485	101.26	200	200 / 100	1

Ref	Tensión/Voltage	Potencia/Power	Capacidad/Capacity	Niveles dispensado Levels dispensed	Niveles de molidos Grinding levels	Dimensiones/Sizes	Peso/Weight
69385	220-240 V ; 50/60 Hz	200 W	60 g (9 cups)	-	-	Ø10x18 cm	780 g
69485	220-240 V ; 50/60 Hz	200 W	200 g (Granos - grains) 100 g (molido - ground)	12	19	15,2x21x26 cm	1.85 Kg

CAFETERA ESPRESSO SENCE

- Household use -

New

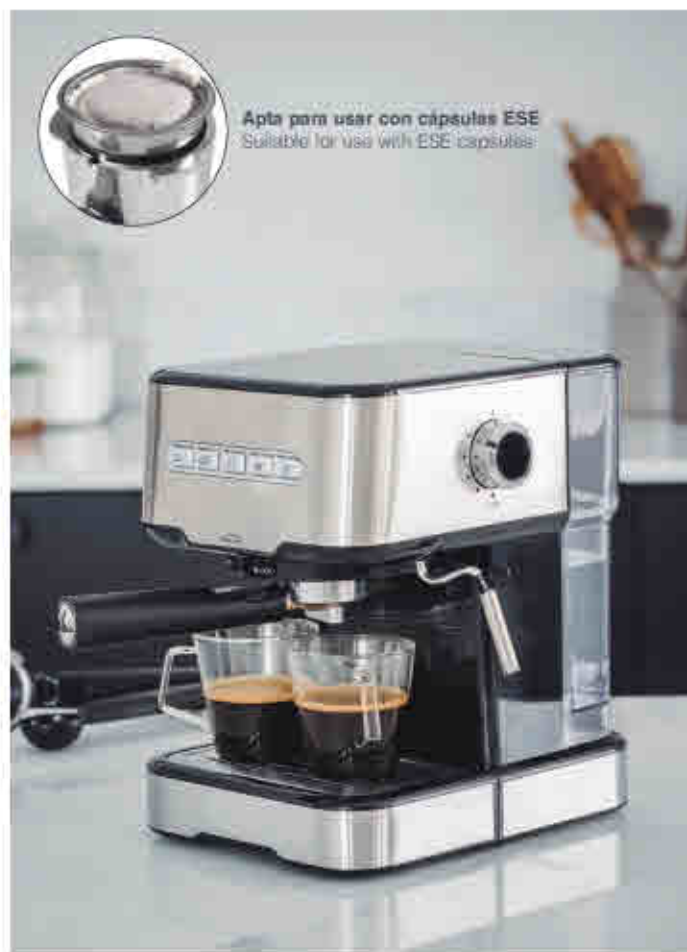

Apta para usar con cápsulas ESE
Suitable for use with ESE capsules



Cafetera espresso ideal para preparar todo tipo de cafés, espresso, capuccino, latte machiato, etc.
Conseguirás un café perfecto y rápido gracias a sus 15 bares de presión.
Fácil de usar, muy intuitiva. Indicadores luminosos en cada función.
Función manual y automática. Permite programar el ciclo de vertido a tu gusto.
Incluye vaporizador con protección para espumar leche y preparar cappuccinos.
Brazo portafiltros con doble salida, te permite preparar uno o dos cafés a la vez.
Bandeja superior caliente tazas de acero inoxidable, calienta la taza previamente para evitar el contraste térmico.
Bandeja de goteo desmontable con indicador de nivel para facilitar la limpieza.
Sistema de ahorro energético con apagado automático.
Apta para usar con café molido y con cápsulas ESE.

Cafetière espresso idéale pour préparer tout type de café, espresso, cappuccino, latte macchiato, etc.
Conviene un café parfait et rapide grâce à ses 15 bars de pression.
Facile à utiliser, très intuitive. Indicateurs lumineux pour chaque fonction.
Fonction manuelle et automatique. Permet de programmer le cycle d'écoulement selon convenance.
Inclut un vaporisateur avec protection pour mousser le lait, chauffer l'eau pour les infusions et préparer des cappuccinos.
Braz porte-filtres avec double sortie, qui permet de préparer un ou deux cafés à la fois.
Plateau réchauffe-tasses en acier inoxydable, qui réchauffe les tasses au préalable pour éviter le choc thermique.
Plateau d'égouttage démontable avec indicateur de niveau pour faciliter le nettoyage.
Système d'économie d'énergie avec arrêt automatique.
Convient pour une utilisation avec du café moulu et des capsules ESE.

Espresso coffee machine, perfect for making all types of coffee, including espresso, cappuccino, latte, macchiato, etc.
You'll have a perfect coffee in no time at all thanks to its 15 pressure bars.
It's easy to use and very intuitive. Each function is accompanied by light indicators.
Manual and automatic settings. You can personalise the pouring time.
Includes a steam wand with a protector for frothing milk, dispensing hot water for teas and preparing cappuccinos.
The two-spout filter holder allows you to make one or two coffees at the same time.
Stainless steel cup-warming tray heats up the cups before using them to keep the coffee warmer for longer.
Detachable drip tray with water level indicator to aid cleaning.
Energy-saving system with automatic shut-off.
Suitable for use with ground coffee and ESE capsules.

Extrae todo el sabor, esencia, aroma y cremosidad del café

Achieve coffee with the best flavour, smell and creaminess



Cafetera Espresso SENCE
Cafetière Espresso
Espresso-Maschine
Espresso coffee maker
cafeteira Espresso

2 posibilidades
Café molido y cápsulas ESE
2 possibilities
Ground coffee and ESE capsules

Ref	€	W	L	U.Venta
69256	155,52	850	150	1



Un café
A coffee

Dos cafés
Gluten free bread

Calentar y espumar leche
Heat and froth milk

Ref	Tensión/Voltage	Potencia/Power	Presión/Pressure	Capacidad/Capacity	Dimensiones/Sizes	Peso/Weight
69256	220-240 V 50/60 Hz	850 W	15 bar	1,50 L	21x26,5x30 cm	3,60 Kg

CAFETERAS DE GOTEO

Inox



Professional use



Depósito agua
Water deposit



Colocación filtro
Filter placement



Máquina de café automática

Machins à café automatique
Automatische Kaffeemaschine
Automatic coffee machine
Máquina automática de café

Ref	€	Filtro	U.Venta
69272	426,41	Ø25	1

Jarra café cristal

Basse en verre pichet
Glass Kaffee Krug
Glas coffee jug
Caneca de café em vidro

Ref	€	L	h (cm)	U.Venta
69273	25,00	1,80	17,50	1



Pack 200 filtros

Pack 200 filtres
Pack200 Filter
Pack filters U.Venta
Pack 200 filtros

Ref	€	Ø (cm)	U.Venta
69274	14,11	25	1
69275	12,14	20	1



Ref	Filtro/Filter	Tensión/Voltage	Potencia/Power	Capacidad/Cap.	Placa calent./Heating plate	Jarra/Termo Pitcher/Thermo	Dimensiones/Sizes	Peso/Weight
69272	69274	220-240 V; 50/60 Hz	2100 W	1,80 L (8 min)	2x80 W (80°C +/-4)	1,80 L Jarra (2)	20x36x41 cm	5,82 Kg



Cafetera de goteo

Cafetière filtre électrique
Filter Kaffeemaschine
Filter coffee machine
Café tipo filtro

Ref	€	W	L	U.Venta
69278	45,34	1000	1,25	1



Portafiltro desmontable
Removable filter holder



Base calentadora
antiadherente
Anti-stick heating base

Puede dosificar la cantidad de café.

Una vez encendida nos podemos desentender de ella.

Si la jarra se completa, mantiene el café caliente y se puede consumir en cualquier momento.

Peut doser la quantité de café.

Une fois allumée, plus besoin de s'en occuper.

Si la verseuse est pleine, elle maintient le café au chaud permettant ainsi de le consommer à tout moment.

Kaffee-Dosierung möglich.

Einmal eingeschaltet brauchen wir uns nicht um sie zu kümmern.

Ist die Karaffe voll, wird der Kaffee warmgehalten und er kann jederzeit getrunken werden.

The amount of coffee used can be controlled. Once switched on we can forget about it and leave it to work.

If a full pot is prepared, it keeps the coffee hot and it can be consumed at any time.

Pode dosar a quantidade de café.

Uma vez ligada, não temos que nos preocupar mais.

Uma vez cheia, a cafeteira mantém o café quente, e pode consumir-se em qualquer momento.

Ref	Tensión/Voltage	Potencia/Power	Tazas/Cups	Capacidad/Capacity	Dimensiones/Sizes	Peso/Weight
69278	220-240 V; 50/60 Hz	1000 W	10	1,25 L	31x21x22 cm	1,25 Kg



Portafiltro desmontable
Removable filter holder



Base calentadora
antifreído
Anti-stick heating base

Mantiene el café caliente durante 30 minutos. Se apaga automáticamente.
Función pausa (antigoteo) para servir.
Programable.

Maintien le café au chaud pendant 30 minutes. S'éteint automatiquement.
Fonction pause (anti-goutte) pour servir.
Programmable.

Hält den Kaffee 30 Minuten warm. Automatische Abschaltung.
Pause-Funktion (tropflos) zum Ausschanken.
Programmierbar.

Keeps the coffee hot for 30 minutes. Switches off automatically.
Pause (anti-drip) function for serving.
Programmable.

Mantém o café quente durante 30 minutos. Apaga-se automaticamente.
Função de pausa (anti-gotejo) para servir.
Programável.

Cafetera de goteo programable

Caletière filtre électrique programmable
Filter-Kaffeemaschine, programmierbar
Filter coffee machine
Programável café tipo filtro

Ref	€	W	L	U.Venta
69279	54,12	1000	1,80	1

Ref	Tensión/Voltage	Potencia/Power	Tazas/Cups	Capacidad/Capacity	Dimensiones/Sizes	Peso/Weight
69279	220-240 V, 50/60 Hz	1000 W	12	1,80 L	28x25x37 cm	3,10 Kg

Apta para todas las jarras de cristal
Suitable for all glass jugs:



Placa de calentamiento Ø11 cm
Heating plate Ø11 cm



Placa calentamiento jarra café

Plaque chauffante pour cruche de café
Heizplatte für Kaffeekanne
Heating plate for coffee jug
Placa de aquecimento caneca de café

Ref	€	Ø Placa	
69281	81,55	11	Simple
69282	101,99	11	Doble / Double

Ref	Tensión/Voltage	Potencia/Power	Temperatura/Temp.	Dimensiones/Sizes	Peso/Weight
69281	220-240 V, 50/60 Hz	90 W	80°C +/-4	19x20,5x7 cm	0,80 Kg
69282	220-240 V, 50/60 Hz	180 W	80°C + 80°C +/-4	38x20,5x7 cm	1,50 Kg

TOSTADORAS

Professional use

Tostado continuo de pan
Continuous bread toasting



Tostadora de cinta transportadora

Toasteur professionnel
Toaster
Conveyor toaster
Torradeira de tapete rolante

Ref	€	W	U.Venta
69065	719,09	1340	1
69066	829,38	2240	1

Hueco útil entre parrillas 5,5 cm
Usable gap between racks 5.5 cm



Bandeja recogemigas
Crumbs tray

Hueco útil entre parrillas
Useful gap between grills



Tostadora horizontal

Grille-pain horizontal
Toaster horizontal
Horizontal toaster
Torradeira horizontal

Ref	€	W	U.Venta
A 69172	301,81	2400	1
B 69173	360,32	3150	1

Ref	Tensión/Voltage	Potencia/Power	Velocidad/Speed	Producción/Product.	Lámp./Lamps	Parrilla/Grill	Dimensiones/Sizes	Peso/Weight
69065	220-240 V; 50 Hz	1340 W	0,46 - 0,73 m/min.	150 h	-	-	53x37x40 cm	12,85 Kg
69066	220-240 V; 50 Hz	2240 W	0,46 - 0,73 m/min.	300 h	-	-	53x45x40 cm	15,50 Kg
69172	220-240 V; 50/60 Hz	2400 W	-	-	6 (3 + 3)	40x24 cm	50x25x28 cm	7,10 Kg
69173	220-240 V; 50/60 Hz	3150 W	-	-	9 (3 + 3 + 3)	40x24 cm	50x25x38cm	9,20 Kg



Ranuras de grandes
dimensiones
Huge slots for toasting

Bandeja recogemigas
Crumbs tray

Bandeja recogemigas
Crumbs tray



Inox



Semiprofessional use

Tostadora Buffet Inox 4-6 ranuras

Grille-pain buffet pour 4-6 tranches
Buffet-Toaster für 4-6 Brötscheiben
4-6 slots st steel buffet toaster
Torradeira buffet 4-6 fatias de pão

Ref	€	Ranuras	W	U.Venta
69294	198,47	4	1800	1
69296	263,63	6	2500	1

Household use

Tostadora LUXE para 2-4 ranuras

Grille-pain LUXE pour 2-4 tranches
LUXE-Toaster für 2-4 Brötscheiben
LUXE 2-4 slots toaster
Torradeira LUXE para 2-4 fatias de pão

Ref	€	W	U.Venta
69164	90,16	1400	1

Ref	Tensión/Voltage	Potencia/Power	Selector/Selector	Ranuras/Slots	Dimensiones/Sizes	Peso/Weight
69294	220-240 V; 50/60 Hz	1800 W	2-4 ranuras - 2-4 slots	15x3 cm	37x21x22 cm	4,80 Kg
69296	220-240 V; 50/60 Hz	2500 W	2-4-6 ranuras - 2-4-6 slots	15x3 cm	48x22,5x22 cm	6,00 Kg
69164	220-240 V; 50/60 Hz	1400 W	2-4 ranuras - 2-4 slots	14x4 cm	32x26x19 cm	2,70 Kg

Household use



Inox

Tostadora automática para 2-4 ranuras

Grille-pain automatique pour 2-4 tranches

Automatik-Toaster für 2-4 Brotscheiben

Automatic 2-4 slots toaster

Torradeira automática para 2-4 fatias de pão

	Ref	€	W	U.Venta
A	69062	43,37	1000	1
B	69064	65,26	1750	1

Ref	Tensión/Voltage	Potencia/Power	Selector/Selector	Ranuras/Slots	Dimensiones/Sizes	Peso/Weight
69062	220-240 V; 50/60 Hz	1000 W	2 ranuras - 2 slots	14x4 cm	19x29x19 cm	1,40 Kg
69064	220-240 V; 50/60 Hz	1750 W	2-4 ranuras - 2-4 slots	14x4 cm	33x29x19cm	3,10 Kg

A
Inox
18/10



Household use

Gracias a su diseño y área de calentamiento podrá tostar todo tipo de panes o bollería y varias rebanadas a la vez.

Grâce à sa conception et sa zone de chauffe, vous pourrez griller tout type de pains ou de viennoiseries et plusieurs tranches à la fois.

Dank des Designs und des Erwärmungsbereichs können Sie alle möglichen Brotsorten und mehrere Scheiben gleichzeitig toasten.

Thanks to its design and heating area you will be able to toast all types of bread and pastries, and several slices at a time.

Gracias ao seu desenho e área de aquecimento, poderá tostar todo o tipo de pães ou bolos, e várias fatias ao mesmo tempo.

B
Inox



6 posiciones de calentamiento
6 heating positions



Aviso sonoro
Alarm



Bandeja recogemigas
Crumbs tray

Tostadora horizontal

Toaster horizontal

Horizontal-/Toaster

Electric toaster

Torradeira horizontal

	Ref	€	W	U.Venta
A	69163	28,43	600	1
B	69363	35,59	600	1

Ref	Tensión/Voltage	Potencia/Power	Temperatura/Temp.	Tostado/Toasted	Parrilla/Grill	Dimensiones/Sizes	Peso/Weight
69163	220-240 V; 50/60 Hz	600 W	360 °C	6	25x20 cm	36x21x6,5 cm	1,00 Kg
69363	220-240 V; 50/60 Hz	600 W	360 °C	6	25x20 cm	42x30x9 cm	1,00 Kg

TOSTADORAS RANURA LARGA

- Household use -



Permite tostar de forma rápida y sencilla, sin necesidad de añadir grasa alguna.
Función de descongelación y cancelación.
Regulador ajustable de tueste, elige entre 7 niveles para tostar a tu gusto.
Ranura alargada para rebanadas extra largas o para más de una rebanada de pan.
Parrilla adicional para calentar bollos o pan (69360).
Incorpora una práctica bandeja, donde se depositan las migas.

Permet de griller de façon rapide et simple sans nécessité d'ajouter aucune graisse.
Fonction de décongélation et d'arrêt.
Régulateur de brunissage réglable, choisissez parmi 7 niveaux pour griller selon vos souhaits.
Rainure allongée pour des tranches extra larges ou pour plus d'une tranche de pain.
Grille supplémentaire pour réchauffer des viennoiseries ou du pain (69360).
Intègre un plateau pratique sur lequel se déposent les miettes.

Für einfaches und schnelles Toasten ohne Fett.
Mit Auftau- und Abbruchtaaste.
Einstellbarer Regler mit 7 Bräunungsstufen ganz nach dem eigenen Geschmack.
Extra lange Röstkammer für eine große oder mehrere kleine Brötscheiben.
Zusätzliches Rost zum Erwärmen von Brötchen oder Brot (69360).
Mit praktischer Krumenwanne.

Fast and easy toasting without the need to use any fatty products.
Defrost and cancel functions.
Adjustable darkness regulator. Choose from 7 levels for toasting as you like.
Long slot for extra wide slices of bread or more than one slice of bread at once.
Additional grill to heat buns or bread (69360).
It has a practical tray for catching crumbs.

Permite tostar de forma rápida e fácil, sem necessidade de acrescentar nenhum tipo de gordura.
Função de descongelação e botão de cancelamento.
Regulador de tostagem com 7 níveis diferentes, para o ajustar ao gosto pessoal.
Ranura longa para fatias extra longas, ou para mais do que uma fatia de pão.
Grelha adicional para aquecer bolos ou pão (69360).
Incorpora uma prática bandeja para recolher as migalhas.



Termostato
7 posiciones de tostado
Thermostat: 7 positions toasted



Dispone de función descongelar
It has a defrost function



Bandeja recogemigas
Crumb tray



Patas de apoyo antideslizantes
Non-slip supports

Ranura alargada de 25 x 4 cm
25 x 4 cm slot for extra wide slices



Ranura alargada de 24,5 x 4 cm
24,5 x 4 cm slot for extra wide slices



Inox

Tostadora doble ranura larga
Grille pain double rainure longue
Toaster mit doppelt langer Öffnung
Double long slots toaster
Dorradeira ranhura larga duplo



Ref	€	W	U.Venta
69260	52,19	1500	1

Inox
18/10

Tostadora ranura larga
Grille-pain rainure longue
Toaster, lange Öffnung
Long slots toaster
Torradeira ranhuras largas

Ref	€	W	U.Venta
69360	53,85	1000	1

Ref	Tensión/Voltage	Potencia/Power	Selector/Selector	Dimensiones/Sizes	Peso/Weight
69260	220-240 V, 50/60 Hz	1500 W	Dos ranuras - Two slots	49x20x23 cm	3,10 Kg
69360	220-240 V, 50/60 Hz	1000 W	Una ranura - One slots	41X12X18,5 cm	1,40 Kg

▶EXPRIMIDORES DE ZUMO

Household use

New



Exprimidor totalmente automático, gracias a su innovadora tecnología la fruta se exprime pulsando solo un botón.
Mecanismo muy eficaz que exprime hasta la última gota del jugo de frutas.
Cono universal que exprime sin problemas el jugo de los pomelos, naranjas, limones o limas.
Sistema de bloqueo de salida de zumo y protección anti-goteo.
Sin salpicaduras durante el funcionamiento gracias a su tapa cerrada.
Patas de goma antideslizantes.
Todas las piezas son desmontables para una fácil limpieza y aptas para lavavajillas.
Libre de BPA.

Presse-agrumes entièrement automatique : les fruits sont pressés en appuyant sur un bouton.
Mécanisme puissant qui presse jusqu'à la dernière goutte du jus des fruits.
Grâce à sa technologie innovante, il n'est pas nécessaire de surveiller la préparation du jus.
Cône universel qui presse sans problèmes le jus des pamplemousses, oranges, citrons ou citrons verts.
Système de blocage de sortie et protection anti-goutte.
Sans éclaboussures pendant le fonctionnement grâce à son couvercle fermé.
Pieds en caoutchouc antidérapants.
Toutes les pièces sont démontables pour un nettoyage facile, et aptes pour le lave-vaisselle.
Sans BPA.

Vollkommen automatische Saftpresse für Saft auf Knopfdruck.
Leistungsfähige Mechanik presst Fruchtsaft bis auf den letzten Tropfen aus.
Innovative Technik bereitet den Saft von allein und ohne Zutun.
Universeller Presskegel für Grapefruit, Orangen, Zitronen oder Limetten.
Mit Überlauf- und Tropfschutz.
Betrieb mit geschlossenem Deckel, sodass nichts heraus spritzt.
Rutschfeste Standfüße.
Einfache Reinigung: alle Teile sind abnehmbar und spülmaschinengeeignet.
Ohne BPA.

Consigue un zumo de cítricos fresco y saludable

Obtain fresh and healthy citrus juice



This totally automatic juicer squeezes fruit with the touch of a button.
It's powerful mechanism squeezes out the last drop of fruit juice.
Thanks to its innovative technology, you don't have to watch whether it makes the juice.
The universal cone easily squeezes juice from grapefruit, oranges and lemons.
It has a system for juico outlet blocking and drip protection.
It doesn't splash while running thanks to its closed lid.
Non-slip rubber feet.
All the parts are removable for easy cleaning and they're also dishwasher safe.
BPA free.

Exprimidor totalmente automático - extra o suco da fruta com um simples toque no botão.
Mecanismo potente, que espreme até a última gota do sumo da fruta.
Graças à sua inovadora tecnologia, não é necessário estar pendente da extração do sumo.
Cone universal, que permite espremer facilmente o sumo de pomelos, laranjas, limões e limas.
Sistema de bloqueio de saída do sumo e proteção anti-goteamento.
A sua tampa evita as salpicaduras durante o funcionamento.
Patas de borracha antidescorantes.
Todas as peças são desmontáveis para facilitar a sua limpeza, e aptas para máquinas de lavar louça.
Não contém BPA.



Exprimidor automático
Presse-agrumes automatique
Automatische Saftpresse
Automatic juicer
Espremedor automático

Ref	€	W	ml	U.Venta
69520	69,72	60	400	1

Ref	Tensión/Voltage	Potencia/Power	Capacidad/Capacity	Dimensiones/Sizes	Peso/Weight
69520	220-240 V; 50/60 Hz	60 W	400 ml	20x19x31 cm	1,75 Kg



Protector de salpicaduras
Comes with a splash guard



Professional use

Fe

Iron

AS

Plastic
TosCo

Exprimidor Profesional
Presse-fruits Professionnelle
Profi-Zitruspresse
Professional squeezer
Espresedor Profesional



Contenedor y cono de acero inoxidable
Container and cone of stainless steel

Professional use

AL

Aluminum
CuboCone

Inox

18/10

Exprimidor Profesional
Presse-fruits Professionnelle
Profi-Zitruspresse
Professional squeezer
Espresedor Profesional



Ref	€	W	U.Venta	Robusto bloque de hierro fundido
69286	187,89	180	1	Robust cast iron block

Ref	€	W	U.Venta	Robusto bloque de aluminio fundido
69283	374,43	230	1	Robust aluminium block

Ref	Tensión/Voltage	Potencia/Power	Velocidad/Speed	Dimensiones/Sizes	Peso/Weight
69286	220-240 V, 50/60 Hz	180 W	1.350 r.p.m.	31x22x35 cm	4,80 Kg
69283	220-240 V, 50/60 Hz	230 W	980 r.p.m.	28x20x40 cm	10,50 Kg



Opción de almacenar el zumo en el contenedor o exprimirlo directamente
Doble cono para distintos cítricos
You can choose whether to juice it into a container, or directly into a cup
Double cone for different citrus fruits

Exprimidor de zumo con brazo
Presse-fruits avec levier
Zitruspresse mit arm
Squeezer with lever
Espresedor se sumos com braço

Ref	€	W	U.Venta
A 69285	56,86	100	1
B 69120	81,03	160	1



Household use

Inox

PP

Polypropylene
CuboCone

AS

Plastic
Comandor-
Container

CE

AC

M

AV

SRU

Puesta en marcha automática al presionar la palanca
Automatic start-up upon pressing the lever

Palanca ergonómica para un mejor agarre y un menor esfuerzo
Ergonomic lever for better grip and minimal effort

Sistema de bloqueo de salida de zumo y anti-goteo
Anti-drip and juice outlet blockage system



Ref	Tensión/Voltage	Potencia/Power	Dimensiones/Sizes	Peso/Weight
69285	220-240 V, 50 Hz	100 W	020x29 cm	1,75 Kg
69120	220-240 V, 50/60 Hz	160 W	19,5x29x29 cm	2,50 Kg



Ideal para exprimir frutas cítricas
Ideal for juicing citrus fruits



Opción de almacenar el zumo en el contenedor o exprimirlo directamente al vaso
You can choose whether to juice it into a container, or directly into a cup

Sistema de bloqueo de salida de zumo y anti-goteo
Anti-drip and juice outlet blockage system



Accionamiento y puesta en marcha presionando el cono hacia abajo
Activate just by pressing the cone downwards

Exprimidor de zumos
Presse-fruit
Zitruspresse
Orange squeezer
Espresmedor de sumos

Ref	€	W	U.Venta
69287	57,48	100	1

Household use



Accionamiento y puesta en marcha presionando el cono hacia abajo
Activate just by pressing the cone downwards

Sistema de bloqueo de salida de zumo y anti-goteo
Anti-drip and juice outlet blockage system



Exprimidor de zumos
Presse-fruit
Zitruspresse
Orange squeezer
Espresmedor de sumos

Ref	€	W	U.Venta
69280	47,10	100	1

Ref	Tensión/Voltage	Potencia/Power	Dimensiones/Sizes	Peso/Weight
69287	220-240 V, 50/60 Hz	100 W	18x16,5x25 cm	1,90 Kg
69280	220-240 V, 50/60 Hz	100 W	Ø14,5x25 cm	1,66 Kg



Dos conos intercambiables
Two different sized interchangeable



Sistema de pulpa regulable
Adjustable pulp system



Exprimidor de zumos ZITRUS
Presse-fruit
Zitruspresse
Orange squeezer
Espresmedor de sumos

Ref	€	W	L	U.Venta
69575	20,44	40	0,75	1



Household use

Dos conos intercambiables de distintos tamaños para exprimir diferentes tamaños de fruta.

Start / Stop automático presionando el cono.

Rotación automática en ambos sentidos: Extrae más zumo que con un exprimidor tradicional.

Sistema de pulpa regulable.

Accesorios totalmente desmontables para una rápida y fácil limpieza.

Aptos para el lavavajillas.

Jarra extraíble graduada de 750 ml / 26 onzas de capacidad.

Tapa transparente protectora y sistema recogecable.

Deux cônes échangeables de différente taille pour presser différents types de fruits.

Start/Stop automatique en appuyant sur le cône.

Rotation automatique dans les deux sens - extrait plus de jus qu'un presse agrumes traditionnel.

Système de pulpe réglable.

Accessoires totalement démontables pour un nettoyage rapide et facile. Apté pour le lave-vaisselle.

Jarre amovible graduée de 750 ml / 26 onces de capacité.

Couvercle transparent protecteur et système ramasse-câble.

Two different sized interchangeable squeezers for juicing different sizes of fruit.

Automatic Start/Stop by pressing the squeezer.

Automatic rotation in both directions - Extracts more juice than a traditional juicer.

Adjustable pulp system.

Fully detachable parts for quick and easy cleaning. Dishwasher safe.

Removable 750ml/26oz capacity measuring jug.

Transparent protective lid and cable retraction system.

Ref	Tensión/Voltage	Potencia/Power	Capacidad/Capacity	Dimensiones/Sizes	Peso/Weight
69575	220-240 V, 50/60 Hz	40 W	750 ml (26 oz)	Ø19x20,5 cm	0,820 Kg



Licuadoras fabricadas en acero inoxidable de alta calidad muy robustas y potentes. Diseñadas para uso continuo.
 Su potente motor, su gran velocidad y su gran orificio de entrada permiten preparar de forma rápida nutritivos zumos de frutas o verduras con expulsión automática de la pulpa.
 Contenedor de residuos de gran tamaño.
 Mecanismo de cierre con interruptor de seguridad.
 Filtro micro perforado de acero inoxidable.
 Componentes desmontables, fáciles de limpiar.

Centrifugeuses abriquées en acier inoxydable de grande qualité, très robuste et puissante. Conçues pour un usage continu.
 Son puissant moteur, sa grande vitesse et son large orifice d'entrée permettent de préparer rapidement des jus de fruits ou de légumes nutritifs avec une expulsion automatique de la pulpe.
 Conteneur de déchets de grande contenance.
 Mécanisme de fermeture avec interrupteur de sécurité.
 Filtre micro-perforé en acier inoxydable.
 Composants démontables, faciles à nettoyer.

Prof-Mixer aus hochwertigem Edelstahl - sehr stabil und leistungsfähig.
 Auf Dauereinsatz ausgelegt.
 Der leistungsfähige Motor, das hohe Drehmoment und seine große Zufuhröffnung ermöglichen nährstoffreiche Frucht- oder Gemüsesäfte im Nu zu bereiten - mit automatischem Frucht-/Gemüseschuss.
 Großer Abfallbehälter.
 Schließmechanismus mit Sicherheitsschalter.
 Feinporiger Filter aus Edelstahl.
 Komponenten sind leicht zu reinigen.

Extremely robust and powerful blender made of high quality stainless-steel.
 Designed for continuous use.
 With its powerful motor, high speed, extra large opening and automatic pulp expulsion you can make nutritious fruit or vegetable juice quickly.
 Large waste container.
 Closing mechanism with a safety switch.
 Stainless steel micro-perforated filter.
 Easy to clean removable components.

Liquidificadores robustos e potentes, fabricados em aço inoxidável de alta qualidade. Concebidas para uso contínuo.
 O seu potente motor, a sua grande velocidade e a grande abertura de entrada permitem preparar de forma rápida nutritivos zumos de frutas ou verduras, com expulsão automática da polpa.
 Recipiente de resíduos de grande tamanho.
 Mecanismo de fecho com interruptor de segurança.
 Filtro microperfurado em aço inoxidável.
 Componentes desmontáveis fáceis de limpar.

Los residuos son recogidos automáticamente.
 The residues are automatically collected.



Licuadora Profesional PRO
 Centrifugeuse Professionnel
 Professioneller Zitrus entsafter
 Professional juice extractor
 Liquidificador Profissional

Ref	€	W	Kg/h	U.Venta
69488	979,92	700	120	1

Los residuos son recogidos automáticamente.
 The residues are automatically collected.



Licuadora de fruta
 Fruit centrifugeuse.
 Zitrus entsafter
 Juice extractor
 Liquidificador de sumos

Ref	€	W	U.Venta
69288	83,93	850	1

Ref	Tensión/Voltage	Potencia/Power	Par mot./M. torque	Conten. residuos/Waste container	Ø Entrada/Entry	Dimensiones/Sizes	Peso/Weight
69488	220-240 V, 50 Hz	700 W	2,9 Nm	6,0 L	9 cm	47,3x25,3x52,2 cm	13,20 Kg
69288	220-240 V, 50 Hz	850 W	0,387 Nm	2,0 L	7,5 cm	30x20x36 cm	4,10 Kg

SLOW JUICER

Household use

Jugos de frutas y verduras 100% saludables
100% healthy fruit and vegetable juices



Tecnología "SLOW" . Mediante el sistema de rotación lenta y el método de prensado en frío, permite obtener todos los nutrientes de frutas y verduras a diferencia de los exprimidores tradicionales. Ultra silencioso. Gracias a su motor de bajas revoluciones.

Bloqueo de salida.

Mezcla frutas y verduras en el interior del recipiente antes de verterlo en la jarra.

Exprime frutas y verduras enteras.

Introduce los ingredientes enteros permitiendo acelerar el tiempo dedicado a la extracción del zumo.

Fácil limpieza. Cepillo para limpiar las partes internas. Accesorios aptos para el lavavajillas.

Technologie "LENTE" . Par son Systeme de rotation lente et la méthode de pression, cela permet de récupérer le maximum des ingrédients du fruit et légumes à la différence des presses fruits traditionnels. Ultra silencieux. Grâce à son moteur à basse tour.

Blocage de sortie.

Capuchon à jus permettant de mélanger les fruits et légumes à l'intérieur du récipient avant de les verser dans les pichets.

Presse les fruits et légumes entiers.

Introduire entièrement les fruits et légumes, gain de temps.

Facile à nettoyer. Brossé fourni. Accessoires compatibles lave vaisselle.

"SLOW" Rotation Engine . The slow rotation system facilitates a cold squeeze that allows the juice preserve all the nutritional properties from vegetables and fruits, unlike traditional squeezers. Ultra-silent. It's engine works in silence and eliminates unnecessary noise.

Juice stopper

Mixes all the desired fruits and vegetables inside the container before serving.

Whole Fruit

The slow juicer lets you work with whole fruits and big pieces of vegetables.

Easy cleaning. A brush incorporated for the inner parts. All pieces are dishwasher compatible



Cuerpo de acero inoxidable
Stainless steel body

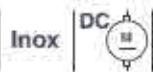

Exprimidor lento
Presse-agrumes lent
Langsamer Fruchtsaftler
Slow juicer
Espremedor lento

Ref	€	W	U.Venta
69372	219.64	200	1



Exprimidor lento alto
Presse-agrumes lent haute
Langsamer Fruchtsaftler, Hoch
High slow juicer
Espremedor lento alto

Ref	€	W	U.Venta
69373	353.68	240	1

Ref	Tensión/Voltage	Potencia/Power	Velocidad/Speed	Capacidad/Capacity	Dimensiones/Sizes	Peso/Weight
69372	230 V, 50/60 Hz	200 W	80 r.p.m	1,0 L	30x16x41 cm	5,50 Kg
69373	230 V, 50/60 Hz	240 W	60 r.p.m	1,0 L	29x20x44 cm	7,30 Kg

BATIDORA PERSONAL PRO

Household use

New



tritan™
BPA free
Dishwasher safe



Batidora de alta calidad, elabora sin esfuerzo batidos, cremas y zumos de fruta y verdura en segundos.
 Dispone de un potente motor de 1200W diseñado para batir con facilidad. Protección contra sobrecalentamiento.
 Las cuchillas de acero inoxidable pulverizan las semillas, cortan las pieles y trituran las partes densas y fibrosas de los alimentos hasta el punto de mantener la máxima cantidad de nutrientes.
 Funcionamiento muy sencillo, solo hay que presionar la jarra para que el motor active las cuchillas.
 Incluye dos jarras de tritán libres de BPA de 1 L y 0,5 L, dos tapas y un asa que se acopla a los vasos para facilitar su agarre.

Mixeur de grande qualité, qui prépare sans efforts des smoothies, des crèmes et des jus de fruits et de légumes en quelques secondes.
 Dispose d'un puissant moteur de 1200W conçu pour battre facilement. Protection contre la surchauffe.
 Les lames en acier inoxydable pulvérisent les graines, coupent les peaux et triturent les parties denses et fibreuses des aliments afin de maintenir une quantité de nutriments maximale.
 Fonctionnement très simple, il suffit d'exercer une pression le bol pour que le moteur active les lames.
 Inclut deux bols en Tritan sans BPA de 1 L et 0,5 L, deux couvercles et une poignée qui s'embote aux bols pour faciliter leur prise en main.

Hochwertiger Mixer, bereitet mühelos und in Sekundenschnelle Smoothies, Cremes sowie Obst- und Gemüsesäfte zu.
 Mit leistungsstarkem 1200W Motor für leichtes Mixen. Überhitzungsschutz.
 Die Messerklingen aus rostfreiem Stahl zerkleinern die Samen, schneiden die Schale und zerkleinern die dichten und faserigen Teile der Nahrung bis zur Erhält der maximalen Menge an Nährstoffen.
 Sehr einfache Bedienung, einfach den Krug drücken, so dass der Motor das Messer aktiviert.
 Enthält zwei 1 L und 0,5 L BPA-freie Tritanumkrüge, zwei Deckel und einen Henkel, der zum leichten Greifen an den Bechern befestigt wird.

High quality blender, effortlessly prepares shakes, creams, and fruit and vegetable juices in seconds.
 Equipped with a powerful 1200W motor designed for easy blending.
 Overheating protection.
 Stainless steel blades grind seeds, cut skins, and purée dense, fibrous parts of the food to the point of maintaining the maximum amount of nutrients.
 Very easy to operate. Just press the pitcher to activate the blades of the motor.
 Includes two 1 L and 0,5 L BPA free blender pitchers, two lids, and a handle that attaches to the cups for easy handling.

Batedeira de grande qualidade, para preparar sem esforço batidos, cremas e sumos de fruta e verduras em poucos segundos.
 Dispõe de um potente motor de 1200 W, pensado para bater e triturar facilmente os alimentos.
 Protecção contra sobreaquecimento.
 As lâminas de aço inoxidável pulverizam as sementes, cortam a casca e trituram as partes mais densas e fibrosas dos alimentos, conservando a máxima quantidade de nutrientes.
 Funcionamento muito simples: basta com pressionar a jarra para que o motor faça mover as lâminas.
 Inclui duas jarras de Tritan, livres de BPA, com capacidade para 1 L e 0,5 L, duas tampas e uma asa que se acopla às jarras para facilitar o seu uso.

Prepara batidos saludables en pocos segundos y disfrútalos donde quieras.

Préparez des smoothies sains en quelques secondes et savourez-les où bon vous semble.
 Gesund Smoothies in wenigen Sekunden zubereiten und überall genießen.
 Prepare healthy smoothies in seconds and enjoy them wherever you want.
 Prepare batidos saudáveis em poucos segundos, para desfrutar em qualquer momento.



Batidora potente Ideal para un estilo de vida saludable

Powerful blender ideal for a healthy lifestyle

2 jarras tritán (0,5/1 L)
Two Tritan pitchers (0,5/1 L)



Batidora personal PRO

Mixeur personnel
Mini-Standmixer
Individual blender
Batedeira pessoal

Ref	€	W	L	U.Venta
69389	85,91	1200	0,5 / 1,0	1

Ref	Tensión/Voltage	Potencia/Power	Jarras/Pitchers	Jarra pequeña Small jug	Jarra grande Big jug	Dimensiones/Sizes	Peso/Weight
69389	220-240 V / 50/60 Hz	1200 W	2	0,5 L	1 L	14x14x40,5 cm	2,40 Kg

PERSONAL BLENDER

- Household use -



Dos jarras portátiles de 600-300 ml de trítan
Two portable bottles (600ml and 300ml)
made from Tritan



Batidora personal MIX & GO
Personnelle mixeur
Personliche mixer
Personal blender
Misturador pessoal

Ref	€	W	ml	U.Venta
69382	42.23	350	600/300	1

Ref	Tensión/Voltage	Potencia/Power	Capacidad/Capacity	Dimensiones/Sizes	Peso/Weight
69382	220-240 V. 50/60 Hz	350 W	600 ml / 300 ml	12x12x40,5 cm	1,05 Kg

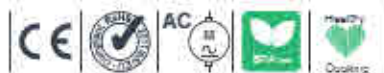

Ideal para preparar pequeñas cantidades de cremas, batidos y zumos de fruta y verdura al instante. Compacta y de gran potencia (350 W), dispone de 4 cuchillas de acero inoxidable especiales para triturar hielo y moler semillas, frutos secos, cereales y café. Permite preparar y transportarlo en el mismo recipiente gracias a su jarra-vaso portátil (de trítan) y cierre hermético. Como complemento, puedes adquirir la funda de neopreno (600 ml) para mantener las bebidas frías más tiempo.

Idéal pour préparer instantanément de petites quantités de crèmes, milk-shakes et jus de fruits et légumes. Compact et d'une grande puissance (350 W), il dispose de 4 lames en acier inoxydable spéciales pour piler la glace et mouler les graines, les fruits secs, les céréales et le café. Permet de préparer et de transporter les préparations dans le même récipient grâce à son pichet/verre portable (en tritan) et sa fermeture hermétique.

Vous pouvez acheter, en tant qu'accessoire, la housse en néoprène (600 ml) pour conserver les boissons froides plus longtemps.

Ideal für die schnelle Zubereitung von Cremes, Shakes und Säften aus Obst und Gemüse in kleinen Mengen. Platzsparend und leistungsstark (350W) mit 4 rostfreien Spezialmessern zum Zerkleinern von Eis und Mahlen von Samen, Trockenobst, Getreide und Kaffee. Zubereitung und Transport im selben Behälter, dank tragbarem und dicht verschließbarem Glaskrug (Jus Tritan). Neoprenhülle (600ml) als Zubehör erhältlich, um die Getränke länger kühl zu halten.

Ideal for preparing small quantities of creams, smoothies and fruit and vegetable juices instantly. Compact and powerful (350 W), it has 4 special stainless steel blades for crushing ice and grinding seeds, nuts, cereals and coffee. Enables you to prepare and transport your juices or smoothies in the same container thanks to its portable bottle-cap (Tritan) with airtight seal.

As an accessory, you can purchase the neoprene sleeve (600 ml) to keep drinks cooler for longer.

Idéal para preparar pequeñas cantidades de cremas, batidos e zumos de frutas e verduras num instante. Compacta e potente (350 W), com 4 lâminas de aço inoxidável especiais para triturar gelo e moer sementes, frutos secos, cereais e café. Permite preparar e transportar os alimentos processados no mesmo recipiente, graças ao seu jarro-vaso portátil (de trítan) com fecho hermético. Como complemento, também pode adquirir a capa de neopreno (600 ml) para manter as bebidas frias durante mais tempo.

Accesorio

Accessoire - Zubehör - Accessorie - Acessório

Impermeable
Waterproof



Funda neopreno
Manchon neoprene
Neopren Hülle
Neoprene sleeve
Luva de neoprene

Ref	€	U.Venta
R69382F	5.29	1

Ideal para proteger la bebida frente a los rayos ultravioleta. Ayuda a mantener la temperatura durante un tiempo más prolongado. Agradable al tacto. Actúa como protector frente a posibles caídas.

Parfait pour protéger la boisson des rayons ultraviolets. Aide à maintenir la température pendant un laps de temps plus long. Agréable au toucher. Agit comme une protection face aux éventuelles chutes.

Zum Schutz des Getränks vor UV-Strahlung geeignet. Bewahrt die Temperatur länger. Angenehm anzufassen. Wirkt als Schutz bei Herunterfallen.

Ideal for protecting drinks from ultraviolet rays. Helps to maintain the temperature for a longer time. Pleasant to touch. Acts as a protector against possible falls.

Válida para proteger a bebida dos raios ultravioleta. Mantém a temperatura da bebida durante mais tempo. Agrável ao tato. Protege o recipiente em caso de queda.

PERSONAL BLENDER MIX & GO C/JARRA

- Household use -

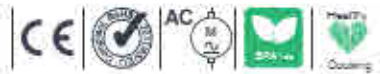

Ideal para preparar pequeñas cantidades de cremas, batidos y zumos de fruta y verdura al instante. Compacta y de gran potencia (350 W), dispone de 4 cuchillas de acero inoxidable especiales para triturar hielo y moler semillas, frutos secos, cereales y café. Permite preparar y transportarlo en el mismo recipiente gracias a su jarra-vaso portátil.

Ideal pour préparer instantanément de petites quantités de crèmes, milk-shakes et jus de fruits et légumes. Compacte et d'une grande puissance (350 W), il dispose de 4 lames en acier inoxydable spéciales pour piler la glace et mouliner les graines, les fruits secs, les céréales et le café. Permet de préparer et de transporter les préparations dans le même récipient grâce à son pichot/verre portable.

Ideal für die schnelle Zubereitung von Cremes, Shakes und Säften aus Obst und Gemüse in kleinen Mengen. Platzsparend und leistungsstark (350W) mit 4 speziellen Spezialmessern zum Zerkleinern von Eis und Mahlen von Samen, Trockenobst, Getreide und Kaffee Zubereitung und Transport im selben Behälter, dank tragbarem und dicht verschließbarem Glaskrug.

Ideal for preparing small quantities of creams, smoothies and fruit and vegetable juices instantly. Compact and powerful (350 W), it has 4 special stainless steel blades for crushing ice and grinding seeds, nuts, cereals and coffee. Enables you to prepare and transport your juices or smoothies in the same container thanks to its portable.

Ideal para preparar pequenas quantidades de cremas, batidos e sumos de frutas e verduras num instante. Compacta e potente (350 W), com 4 lâminas de aço inoxidável especiais para triturar gelo e moer sementes, frutos secos, cereais e café. Permite preparar e transportar os alimentos processados no mesmo recipiente, graças ao seu jarro-vaso portátil.

Jarra de vidrio templado (500 ml)

High quality toughened glass (500 ml)



Incluye 4 pajitas desechables de papel ecológico
Includes 4 disposable straws made from eco-friendly paper



Cuchillas de acero inoxidable especiales para triturar hielo y moler semillas, frutos secos, cereales y café.

Special stainless steel blades for crushing ice and grind seeds, nuts, cereals and coffee.



Jarra de vidrio templado de gran grosor, alta calidad, duradera y resistente. Apta para el lavavajillas
Durable, sturdy jug made from very thick, high quality toughened glass. Dishwasher safe.



Tapa de metal con rosca
Metal lid with screw cap

Batidora personal MIX & GO con jarra de cristal

Mixeur personnel MIX & GO avec bol en verre.
Mini-Standmixer MIX & GO mit Glasbehälter.
MIX & GO individual blender with glass jug
Batedeira pessoal MIX & GO com jarra de vidro

Ref	€	W	U.Venta
69386	39,32	350	1

Ref	Tensión/Voltage	Potencia/Power	Capacidad/Capacity	Altura jarra/Height jar	Dimensiones/Sizes	Peso/Weight
69386	220-240 V, 50/60 Hz	350 W	500 ml	23 cm	Ø12 x 31 cm	1,50 Kg

Accesorios

Accessoires · Zubehör · Accessories · Acessórios

Perfecta para servir todo tipo de bebidas como batidos, zumos, té, etc.
Vidrio templado de gran grosor, alta calidad, duradera y resistente.
Tapas de metal con orificio central para introducir la pajita.

Ideal for serving all kinds of drinks, such as smoothies, juices, tea etc.
 Durable, sturdy jug made from very thick, high quality toughened glass.
 Metal lid with central hole for straw insertion.
 Strong disposable straws made from eco-friendly paper.



Set 2 jarras de cristal

Set de 2 pichets en verre
 2er-Set Glasbehälter
 Set of 2 glass pitchers
 Conjunto de 2 jarras de vidrio

Ref	€	ml	U.Venta
69387	16.39	500	1

Biodegradables. No se deforman y ni transmiten ningún sabor.
Ideal para disfrutar todo tipo de refrescos.
Certificación FDA, apta para el uso alimenticio.

Biodegradable. They don't distort or transfer any flavour.
 Perfect for enjoying all kinds of drinks.
 FDA certified, suitable for use with food.



Set 50 pajitas de papel Ecológicas

Set de 50 pailles en papier écologiques
 Papierstrohhalme umweltfreundlich 50-er-Set
 Set of 50 eco-friendly paper straws
 Conjunto de 50 palhinhas de papel Ecológicas

Ref	€	Ø (mm)	h (cm)	e (mm)	g/mm2	U.Venta
69339	4.15	6	23	0.3	310	1

Pajitas reutilizables de acero inoxidable de gran calidad.
No se oxidan, agrietan, rayan o rompen.
La referencia 63132 destaca por su elegante acabado en color cobre.
La mejor alternativa a las pajitas de plástico de un solo uso.
Ecológicas, respetuosas con el medio ambiente.
Incluye cepillo para facilitar la limpieza. Aptas para el lavavajillas.

High quality reusable stainless steel straws.
 They don't rust, crack, scratch or break.
 Reference 63132 stand out thanks to their elegant finish in copper color.
 The ideal alternative to single use plastic straws. Environmentally friendly.
 Comes with a brush for easy cleaning. Dishwasher safe.

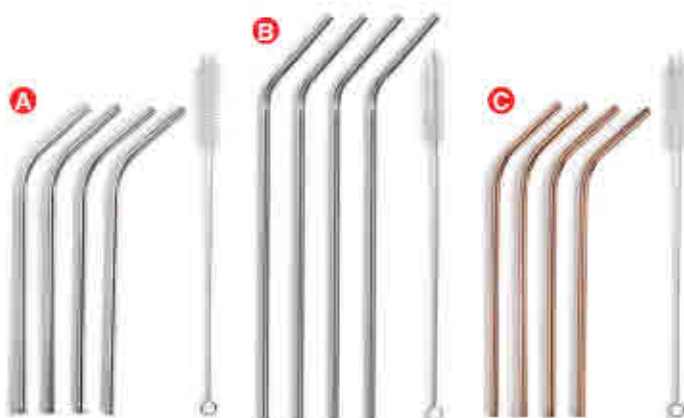

Inox 18/10

Set 4 pajitas + cepillo

Set de pailles + brosse
 4er-Set Strohhalm mit Reinigungsbürste
 Set of 4 straws + cleaning brush
 Conjunto de 4 palhinhas + escova

	Ref	€	Color	Ø (mm)	h (cm)	U.Venta
A	63131	4.25	Inox	6	21.5	1
B	69338	3.94	Inox	6	25.5	1
C	63132	6.33	Copper	6	21.5	1

Fabricadas en cristal borosilicato de máxima calidad, resistente a los golpes.
Extremadamente duraderas y seguras de usar. Esquinas redondeadas.
Reutilizables, higiénicas y ecológicas.
Fácil limpieza. Incluye cepillo. Aptas para el lavavajillas.

Made of high quality impact resistant borosilicate glass.
 Extremely durable and safe to use. Rounded corners.
 Reusable, hygienic, and ecological.
 Easy cleaning. Includes brush. Dishwasher safe.

Cristal

Set 4 pajitas + cepillo GLASS

Set de pailles + brosse
 4er-Set Strohhalm mit Reinigungsbürste
 Set of 4 straws + cleaning brush
 Conjunto de 4 palhinhas + escova

Ref	€	Ø (mm)	h (cm)	U.Venta
63133	2.59	6	21.5	12



BATIDORAS PROFESIONALES

Professional use



Batir, picar y moler

Batir, hachar et mouler.
Blend, chop and grind



Batidora Profesional BLACK

Batteur Professionnel
Profi-Mixer
Professional blender
Batedor Profissional

Ref	€	W	L	U.Venta
69195	417,80	1200	2,0	1

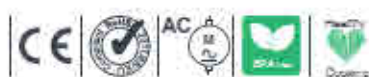

Incluyen **RECETARIO**
RECIPE BOOK included
Lauri Bengochea

Potencia y resultados profesionales.

Disfruta del placer de cocinar con la Batidora Profesional. Gracias a su gran rendimiento, potente motor, calidad y durabilidad lograrás resultados extraordinarios.

La batidora ofrece una gran versatilidad y es ideal para elaborar todo tipo de zumos, batidos, sopas, salsas, patés, granizados, helados etc.

Incluye un completo recetario con todo tipo de recetas diseñado por Lauri Bengochea (www.mitallerdebienestar.com) en exclusiva para Lacor.

Performance et résultats professionnels

Cuisez avec plaisir grâce au Blender Professionnel. Sa performance, son puissant moteur, sa qualité et durée de vie vous donneront des résultats extraordinaires.

Le blender offre une grande flexibilité et est idéal pour élaborer tout type de jus, smoothies, soupes, sauces, pâtés, granizado (boissons rafraichissantes), glaces, etc.

Il contient un livre de recettes élaboré par Lauri Bengochea (www.mitallerdebienestar.com) en exclusivité pour Lacor.

Meisterhafte Leistung und Ergebnisse.

Mit diesem Profi-Mixer macht Kochen Spaß. Dank seiner Ergiebigkeit, Power, Qualität und Langlebigkeit gelingt alles bestens.

Der Mixer ist sehr vielseitig und eignet sich perfekt zum Bereiten von Säften, Shakes, Suppen, Saucen, Pasteten, Slush, Eis usw.

Somit Rezeptheft von Lauri Bengochea mit vielen leckeren Rezepturen (www.mitallerdebienestar.com) - speziell für Lacor.

Power and Professional Results.

Enjoy the pleasure of cooking with the Professional Mixer. Thanks to its high performance, powerful motor, quality and durability you'll get extraordinary results.

The mixer is extremely versatile and perfect for making all kinds of juices, shakes, soups, sauces, pâtés, iced drinks, ice cream and more.

It comes with a complete cookbook with all kinds of recipes designed exclusively for Lacor by Lauri Bengochea (www.mitallerdebienestar.com).

Potência e resultados profissionais.

Desfruta do prazer de cozinhar com a Batedeira Profissional.

De grande qualidade e durabilidade, o seu grande rendimento e o seu potente motor permitir-te-ão alcançar resultados extraordinários.

De grande versatilidade, a batedeira é ideal para elaborar todo o tipo de sumos, batidos, sopas, molhos, patés, granizados, gelados, etc.

Inclui um completo livro com todo o tipo de receitas, da autoria de Lauri Bengochea (www.mitallerdebienestar.com) criado em exclusivo para Lacor.



Batidora Profesional WHITE

Batteur Professionnel
Profi-Mixer
Professional blender
Batedor Profissional

Ref	€	W	L	U.Venta
69295	351,36	1200	1,5	1

Ref	Tensión/Voltage	Potencia/Power	Velocidad/Speed	Capacidad/Capacity	Dimensiones/Sizes	Peso/Weight
69195	220-240 V; 50/60 Hz	1200 W	13.300 - 38.000 r.p.m	2,0 L	28x26x52 cm	5,00 Kg
69295	220-240 V; 50/60 Hz	1200 W	13.000 - 38.000 r.p.m	1,5 L	18x24x42 cm	4,00 Kg

Resultados profesionales · Résultats professionnels · Professional results

Gran rendimiento, versatilidad y durabilidad · Grand rendement, versatilité et durabilité · Great performance, versatility and durability



Accesorios

Accessoires · Zubehör · Accessories · Acessórios

Apta para las batidoras 69195 y 69295

Apte pour les mixeurs 69195 et 69295
Geeignet für die Mixer 69195 und 69295
Apt for blenders 69195 and 69295
Apta para as batadeiras 69195 e 69295



Jarra batidora con cuchillas

Pot bateur avec lames!!
Krug mit Messer für Mixer
Blender jug with blades
Jarra batidora com lâminas

Ref	€	L	U.Venta
R69195N	163.93	2,0	1



tritan
material

Apta para las batidoras 69195 y 69295

Apte pour les mixeurs 69195 et 69295
Geeignet für die Mixer 69195 und 69295
Apt for blenders 69195 and 69295
Apta para as batadeiras 69195 e 69295



Jarra batidora con cuchillas

Pot bateur avec lames!!
Krug mit Messer für Mixer
Blender jug with blades
Jarra batidora com lâminas

Ref	€	L	U.Venta
R69295A	161.75	1,5	1



tritan
material



Aísla y reduce el nivel de ruido un 80%. Apta para las batidoras 69195 y 69295

Isole et réduit le niveau de bruit de 80%. Apte pour les mixeurs 69195 et 69295
Isoliert und reduziert den Geräuschpegel um 80%. Geeignet für die Mixer 69195 und 69295
Isolates and reduces the noise level by 80%. Apt for blenders 69195 and 69295
Isola e reduz em 80% o nível de ruído. Apta para as batadeiras 69195 e 69295

NOTA

La carcasa solo es valida si las batidoras llevan la jarra baja (R69295A), NUNCA con la jarra alta (R69195N).

REMARQUE

La carcasse n'est valable que si les mixeurs possèdent un bol bas (R69295A), JAMAIS avec un bol haut (R69195N).

ANMERKUNG

Das Gehäuse kann nur verwendet werden, wenn die Mixer mit einem niedrigen Krug ausgestattet sind (R69295A). KEINESFALLS mit dem hohen Krug verwenden (R69195N).

NOTE

The casing is only valid if the blender comes with a lower recipient (R69295A), NEVER for a higher recipient (R69195N).

NOTA

A carcassa só é utilizável se as batadeiras utilizam o jarro baixo (R69295A). NUNCA utilizar se a batadeira utiliza o jarro alto (R69195N).

PC

Polycarbonate

Carcasa aislante de ruido

Bollier isolant du bruit!
Geräuschdämpfendes Gehäuse
Noise reducing enclosure
Carcassa isolante do ruído

Ref	€	cm	h (cm)	U.Venta
R692958	209.99	25x30	46	1



Posibilidad de encastrar

Dimensiones del agujero: 25,5 x 26,5 cm

Possibilitat d'encastar

Dimensions du trou: 25,5 x 26,5 cm

Möglichkeit von encastré

Abmessungen des Lochs: 25,5 x 26,5 cm

Encastable option

Dimensions of the hole: 25,5 x 26,5 cm

Possibilitade do encastrar

Dimensões do furo: 25,5 x 26,5 cm

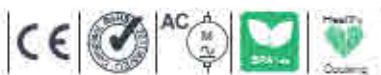

69581 - Batidora INOX

Ideal para elaborar todo tipo de zumos, batidos, cremas, salsas, granizados, etc. Potente motor de 1000 W para licuar, mezclar y triturar de manera rápida y eficaz. Control de velocidad variable con display luminoso, seleccione la velocidad deseada con la ruleta.

Tres funciones pre-establecidas; Pulse · Ice crush · Smoothie. Velocidad PULSE para batir al gusto a máxima velocidad.

Velocidad ICE CRUSH, función especial para picar hielo.

Jarra de vidrio borosilicato con escala (ml / cups / oz) de alta calidad, resistente a los arañazos de 1,50 L.

Vaso medidor de 50 ml / 1-3 / 4 oz.

6 cuchillas lisas desmontables de acero inoxidable de alta calidad.

Cuerpo en acero inoxidable. Pies antideslizantes, aportan estabilidad a la hora del uso.

Ideal pour préparer tout type de jus, milk-shakes, crèmes, sauces, granisés, etc. Puissant moteur de 1000 W pour mixer, mélanger et triturer de façon rapide et efficace. Contrôle de vitesse variable avec affichage lumineux, sélection de la vitesse souhaitée avec le bouton rotatif.

Trois fonctions pré-établies Pulse · Ice crush · Smoothie. Vitesse PULSE pour mixer à sa guise à la vitesse maximum.

Vitesse ICE CRUSH, fonction spéciale pour piler la glace.

Boî en verre borosilicaté avec graduations (ml / cups / oz) de grande qualité, résistant aux rayures de 1,50 L.

Verre doseur de 50 ml / 1-3 / 4 oz.

6 lames lisses démontables en acier inoxydable de grande qualité.

Corps en acier inoxydable. Pies antidérapants, qui apportent une stabilité lors de l'utilisation.

Ideal for making all types of juices, smoothies, creams, sauces, slushies, etc. Powerful 1000 W motor to liquefy, mix, and chop quickly and efficiently.

Variable speed control with illuminated display, select the desired speed using the selector knob.

Three pre-set functions, Pulse · Ice Crush · Smoothie.

PULSE speed to blend foods to desired texture at maximum speed.

ICE CRUSH speed, special function for crushing ice.

High quality scratch-resistant borosilicate glass pitcher (ml / cups / oz) 1.5 L.

Measuring cup 50 ml / 1-3/4 oz.

6 detachable high quality stainless steel blades.

Stainless steel body. Anti-slip base, provides stability in operation.



69587 - Batidora WHITE

Ideal para elaborar todo tipo de zumos, batidos, cremas, salsas, granizados, etc. Potente motor de 700 W para licuar, mezclar y triturar de manera rápida y eficaz.

2 velocidades + Pulse, seleccione la velocidad deseada con la ruleta.

Velocidad PULSE para batir al gusto a máxima velocidad.

Jarra de cristal con escala (ml / cups / oz) de alta calidad resistente a los arañazos de 1,50 L con cierre de seguridad.

Vaso medidor de 50 ml / 1-3/4 oz.

4 cuchillas lisas desmontables de acero inoxidable de alta calidad.

Pies antideslizantes, aportan estabilidad a la hora del uso.

Ideal pour élaborer tous types de jus, smoothies, soupes, sauces, crèmes, granisés, etc. Puissant moteur de 700 W pour mixer, mélanger et triturer de façon rapide et efficace.

2 vitesses + Pulse, sélection de la vitesse souhaitée avec le bouton rotatif.

Vitesse PULSE pour mixer à la vitesse maximum.

Boî en verre avec graduation (ml / cups / oz) de grande qualité résistant aux rayures de 1,50 L avec fermeture de sécurité.

Verre mesureur de 50 ml / 1-3/4 oz.

4 lames lisses démontables en acier inoxydable de grande qualité.

Pieds antidérapants, qui apportent une stabilité lors de l'utilisation.

Perfect for making all kinds of juices, shakes, soups, sauces, pastes, smoothies, etc.

Powerful 700 W motor for blending, mixing and grinding quickly and effectively.

2 speeds + Pulse, select the speed you want with the dial.

PULSE speed for beating food as you like at maximum speed.

High quality 1.5 L scratch resistant glass pitcher with measurements (ml/cups/oz) with safety latch.

50 ml / 1-3/4 oz measuring cup.

4 high quality stainless steel removable smooth blades.

Non-slip feet provide stability during use.

Sistema Patented



Eje central conjunto - Axe central de l'ensemble - Central assembly axis

Eje central cuchillas - Axe central des lames - Central blades axis

Eje central de las cuchillas descentrada respecto al eje central del conjunto
Crea vórtices irregulares, evita obstrucciones y genera cortes más profundos

Axe central des lames décentré par rapport à l'axe central de l'ensemble
 Crée des vortex irréguliers, évite les obstructions et génère des coupes plus profondes

Central blade axis offset from the central assembly axis
 Creates uneven vortices, avoid blockages and make deeper cuts

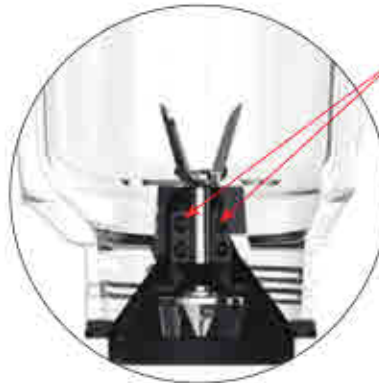

Doble rodamiento - Double ball bearing

Alarga la vida útil de las cuchillas
 Allonge la durée de vie des lames
 Verlängert die Lebensdauer der Messer
 Extend the lifespan of the blades
 Prolonga a vida útil das lâminas

Cierre de seguridad
 Safety latch

Jarra marcada en mililitros, cups y onzas
 Jug marked in millilitres, cups and ounces

Jarra marcada en mililitros, cups y onzas
 Jug marked in millilitres, cups and ounces



Cuerpo de acero inoxidable
 Stainless steel body

Inox

Batidora INOX
 Mélangeur
 Mixer
 Blender
 Batedor

Batidora WHITE
 Mélangeur
 Mixer
 Blender
 Batedor

Ref	€	W	L	U.Venta
69581	135,81	1000	1,50	1

Ref	€	W	L	U.Venta
69587	69,51	700	1,50	1

Ref	Tensión/Voltage	Potencia/Power	Velocidad/Speed	Cap.Capacity	Medidor/ Measurer	Cuchillas/Blades	Dimensiones/Sizes	Peso/Weight
69581	220-240 V, 50 Hz	1000 W	11.000 - 16.500 r.p.m.	1,50L (6 cups/48oz)	50 ml	6	20,5x20x41,5 cm	4,00 Kg
69587	220-240 V, 50 Hz	700 W	14.392 - 16.000 r.p.m.	1,50L (6 cups/48oz)	50 ml	6	22x18x40 cm	3,40 Kg



Inox

Batidor con jarra de cristal

Mixer avec jarre en verre
Mixer mit Glaskrug
Blender with glass jug
Batedor com jarra de vidro

Ref	€	W	L	U.Venta
69081	72.83	500	1,5	1



Batidor con jarra

Mixer avec jarre
Mixer mit krug
Blender with jug
Batedor com jarra

Ref	€	W	L	U.Venta
69194	159.98	750	1,5	1

Ref	Tensión/Voltage	Potencia/Power	Velocidad/Speed	Capacidad/Capacity	Dimensiones/Sizes	Peso/Weight
69081	220-240 V; 50/60 Hz	500 W	10.000 - 12.000 r.p.m.	1,50 L	21x23x40 cm	3,24 Kg
69194	220-240 V; 50/60 Hz	750 W	20.500 r.p.m.	1,50 L	19,5x21x41 cm	4,25 Kg



Inox

Batidora para sopa

Blender chauffeur
Suppenhersteller
Soup maker
Máquina a sopa

Ref	€	W	L	U.Venta
69380	184.58	450	1,7	1

Cocine sopas caseras, salsas, purés, cremas, batidos, zumos, cócteles, etc.
Sauter ingrédients, cociner a fuego lento o hervir sopas.
Mezcla los ingredientes durante el proceso de cocción.
Pica hielo en menos de 50 segundos y mezcla desde batidos hasta cócteles congelados.

Cuisinez des soupes maison, des sauces, des purées, des crèmes, des milk-shakes, des jus de fruit, des cocktails, etc.
Sauter les ingrédients, cuisiner à feu doux ou faire bouillir des soupes.
Mélange les ingrédients pendant le processus de cuisson.
Pile la glace en moins de 50 secondes et mélange aussi bien des milk-shakes que des cocktails congelés.

Bereiten Sie hausgemachte Suppen, Püree, Cremes, Shakes, Säfte, Cocktails usw. zu. Anbraten von Zutaten, langsames Kochen oder Bräuen von Suppen. Die Zutaten werden während des Kochvorgangs gemischt.
Eis wird in unter 50 Sekunden zerkleinert und es werden Shakes und sogar gefrorene Cocktails gemischt.

Prepare home-made soups, sauces, purées, creams, milkshakes, juices, cocktails, etc.
Sautéing ingredients, cooking at low heat or boiling soups. Mixes the ingredients during the cooking process.
Crushes ice in under 50 seconds and mixes anything from milkshakes to frozen cocktails.

Elabore sopas caseiras, molhos, purés, cremas, batidos, zumos, cocktails, etc.
Sauter ingrédients, cocinar a fogo lento ou ferver sopas.
Misturando os ingredientes durante o processo de cocção.
Pica gelo em menos de 50 segundos, e mistura desde batidos até cocktails congelados.

Ref	Tensión/Voltage	Potencia/Power	Calentamiento/Heating	Velocidad/Speed	Capacidad/Capacity	Dimensiones/Sizes	Peso/Weight
69380	220-240 V; 50/60 Hz	450 W	700 - 900 W	17.000 r.p.m.	1,70 L	25x21x45 cm	2,40 Kg

COCCIÓN Y CONSERVACIÓN AL VACÍO

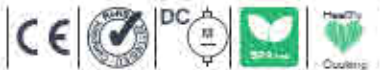

¿Qué es la cocción al vacío?

Beneficios de la cocción a baja temperatura:

Entre las nuevas técnicas de restauración, la más importante es la cocción y conservación al vacío. Las ventajas que ofrece esta técnica aseguran su introducción y adaptación a las necesidades de cada cocina: ganar tiempo, mejora de costes, mejor organización del personal y mayor duración de los productos, manteniendo sus cualidades higiénicas y organolépticas, son algunas de las principales razones que auguran su éxito e introducción en la Restauración.

Hablamos de productos sometidos a un proceso de envasado al vacío y expuestos a temperaturas que nunca superan los 100°C. Debido a la diferencia de presión, conseguimos temperaturas de ebullición del agua a baja temperatura y la penetración de temperatura a corazón de producto es lineal, es decir, no encuentra moléculas de aire y no produce una reacción radial, por lo que el tratamiento y los resultados obtenidos con el producto están perfectamente controlados.

La forma más sencilla de explicar la cocción al vacío es decir que en vez de guisar, como es tradicional, los alimentos a 130°C de calor por un periodo relativamente corto, aquí se cuecen entre 65°C y 99°C en tiempos más prolongados según la naturaleza del género y su peso. Es, pues, una cocción larga y a baja temperatura. En un horno convencional, una pieza de carne se cuece a 200°C de temperatura, lo que ocasiona que el exterior se tueste. Sin embargo, la temperatura en el corazón de la pieza rara vez supera los 50°C. Por lo tanto, sólo es necesaria una temperatura igual o ligeramente superior a los 65°C para cocer un alimento, evitando el resecamiento y el endurecimiento de la fibra muscular así como la sobrecoCCIÓN.

Qu'est-ce que la cuisson sous-vide ?

Avantages de la cuisson à basse température :

Parmi les nouvelles techniques de restauration, la plus importante est la cuisson et la conservation sous-vide. Les avantages qu'offre cette technique garantiront son introduction et son adaptation aux besoins de chaque cuisine : gagner du temps, améliorer les coûts, une meilleure organisation du personnel et une plus grande durée de conservation des produits, en maintenant leur qualité hygiéniques et organoleptiques, sont quelques-unes des raisons principales qui expliqueront son succès et son introduction dans la restauration.

Nous parlons de produits soumis à un processus de conditionnement sous-vide et exposés à des températures toujours inférieures à 100°C. En raison de la différence de pression, on obtient des températures d'ébullition de l'eau à basse température et la pénétration de la température au cœur du produit est linéaire, c'est-à-dire qu'elle ne rencontre pas de molécules d'air et ne produit aucune réaction radiale, c'est pourquoi le traitement et les résultats obtenus avec le produit sont parfaitement contrôlés.

La façon la plus simple d'expliquer la cuisson sous-vide est de dire qu'au lieu de cuisiner, comme c'est le cas traditionnellement, les aliments à une température de 130°C pendant un laps de temps relativement court, ils sont ici cuits entre 65°C et 99°C pendant un laps de temps plus long selon la nature du genre et le poids. Il s'agit donc d'une cuisson longue et à basse température. Dans un four conventionnel, une pièce de viande est cuite à une température de 200°C, ce qui provoque le brunissage de l'extérieur. Cependant, la température au cœur de la pièce dépasse rarement 50°C. Par conséquent, il suffit d'une température égale ou légèrement supérieure à 65°C pour cuire un aliment, évitant ainsi le dessèchement et le durcissement de la fibre musculaire ainsi que la surcuisson.

What is Sous Vide?

The benefits of low-temperature cooking

Among the new techniques for cooking professionals, the most important one is cooking and storing food in vacuum sealed pouches. The advantages of the technique mean it will be used in and adapted to the needs of every kitchen. Some of the main reasons why it will be successful and widely used in the hospitality industry are the savings in time and money, better staff organisation and being able to store products longer without sacrificing organoleptic qualities or hygiene.

Sous vide refers to products that are vacuum sealed and never exposed to temperatures above 100° C. Because of the difference in pressure, water boils at a low temperature and heat penetrates into the heart of the product in a linear fashion which means there is no interference from air molecules and a radial reaction does not occur so consequently product manipulation and results can be perfectly controlled.

The simplest way to explain sous vide is to say that instead of the traditional method of cooking food at 130°C for a relatively short time food is cooked at 65°C to 99°C for a longer time, depending on the type of product and how much it weighs. It's essentially slow cooking at a low temperature. In a conventional oven, a piece of meat is cooked at 200°C, which makes the outside brown and crispy. However, the temperature in the centre rarely exceeds 50°C. So you can see that meat only needs to be cooked at 65°C or a little hotter, which prevents it from drying out or getting tough as well as over cooking.

Tabla orientativa - Tableau d'orientation - Guidance table

Almacén Storehouse	25°C +/- 2°C									
Almacenamiento normal Normal storage life					1-2 semanas 1-2 weeks	3-4 días 3-4 days	2-4 días 2-4 days	1 semana 1 week	5-6 meses 5-6 months	
Sellado al vacío Vacuum sealed life					2-4 semanas 2-4 weeks	2 semanas 2 weeks	2 semanas 2 weeks	2-4 semanas 2-4 weeks	1 año 1 year	
Frigorífico Fridge	5°C +/- 2°C									
Almacenamiento normal Normal storage life		1-2 semanas 1-2 weeks	1 semana 1 week	1 semana 1 week	3-4 días 3-4 days	2-4 semanas 2-4 weeks	1-2 semanas 1-2 weeks	1-2 semanas 1-2 weeks	1-2 semanas 1-2 weeks	2-3 días 2-3 days
Sellado al vacío Vacuum sealed life		1 mes 1 month	2-4 semanas 2-4 weeks	2-4 semanas 2-4 weeks	2 semanas 2 weeks	1 mes 1 month	1 mes 1 month	6-12 semanas 6-12 weeks	6-12 semanas 6-12 weeks	1 semana 1 week
Congelador Freezer	-16°C +/- 2°C									
Almacenamiento normal Normal storage life		6 meses 6 months	6 meses 6 months	6 meses 6 months	1-2 semanas 1-2 weeks	8 meses 8 months	8 meses 8 months	6-12 semanas 6-12 weeks	4 meses 4 months	
Sellado al vacío Vacuum sealed life		2-3 años 2-3 years	2-3 años 2-3 years	2-3 años 2-3 years	2 años 2 years	2-3 años 2-3 years	2-3 años 2-3 years	6 meses 6 months	1 año 1 year	

▶ MÁQUINAS DE VACÍO CAMPANA

Professional use

Altura interior útil 11 cm
11 cm useful interior height



Admite la aspiración de líquidos y salsas, sin necesidad de congelarlos antes.
Envasado por mediación de un COMPRESOR DE AIRE.
Compresor con pistón, dispone de válvula de entrada y salida de aire.
Al no ser de aceite no suele precisar mantenimiento alguno.

Permet l'aspiration de liquides et de sauces, sans avoir à les congeler auparavant.
Mise sous vide au moyen d'un COMPRESSEUR D'AIR.
Compresseur avec piston, dispose de valve d'entrée et de sortie d'air.
Dans la mesure où il n'y a pas d'huile, aucun entretien n'est nécessaire.

Ermöglicht das Absaugen von Flüssigkeiten und Saßen im Beutel, ohne dass diese vorher eingefroren werden müssen.

Abfüllung mit Hilfe eines DRUCKLUFTKOMPRESSORS.
Kolbenkompressor mit Druckluhein- und -ausgangsverf.
Da kein Öl komprimiert wird, ist normalerweise keine Wartung erforderlich.

Enables liquids and sauces to be aspirated in the bag with no need to freeze them first.
U. vacuaging using an AIR COMPRESSOR.
Compressor with piston, has an air inlet/outlet valve.
As it is not oil based, no maintenance is required.

Admite a aspiração de líquidos e de molhos, sem necessidade de os congelar previamente.
Embalagem por meio de um COMPRESOR DE AR.
O compressor de pistão dispõe de válvula de entrada e saída de ar.
Ao não utilizar óleo, não exacer qualquer tipo de manutenção.

Inox

Máquina de vacío campana

Machine sous vide à cloche
Vakuumiergeräte
Bell-shaped vacuum machine
Máquina de vacío tipo cámara

Ref	€	W	U.Venta
69116	1.485,18	630	1

Ref	Tensión/Voltage	Potencia/Power	Vacío/Vacuum	Caudal bomba/Pump flow	L. sellado/Seal length	A. sellado/Seal width	Dimensiones/Sizes	Peso/Weight
69116	220-240 V, 50 Hz	630 W	0,9 bar	83 L/min	29 cm	4 cm	42x36x36,5 cm 35x30x5 cm (cámara interior)	24,5 Kg



Bobina incluida
Coil tube included.



Realización de bolsas.

Admite la aspiración de líquidos y salsas, sin necesidad de congelarlos antes.

Réalisation de sachets.
Permet l'aspiration de liquides et de sauces, sans avoir à les congeler auparavant.

Erstellung von Beuteln.
Ermöglicht das Ansaugen von Flüssigkeiten und Saßen ohne vorheriges Gefrieren in die VerU-Verpackung.

Making bags.
Enables liquids and sauces to be aspirated in the bag with no need to freeze them first.

Confecionar sacos.
Admite a aspiração de líquidos e de molhos, sem necessidade de os congelar previamente.



Inox

Máquina de vacío campana

Machine sous vide à cloche
Vakuumiergeräte
Bell-shaped vacuum machine
Máquina de vacío tipo cámara

Ref	€	W	U.Venta
69352	844,63	350	1

Ref	Tensión/Voltage	Potencia/Power	Vacío/Vacuum	Caudal bomba/Pump flow	L. sellado/Seal length	A. sellado/Seal width	Dimensiones/Sizes	Peso/Weight
69352	220-240 V, 50/60 Hz	350 W	0,9 bar	60 L/min	30 cm	2,5 cm	42x38x27 cm 30,5x32,2x5 cm (cámara interior)	10 Kg

▶ MÁQUINAS DE VACÍO PROFESIONALES

Professional use



Máquina de envasado al vacío profesional, prestaciones de primer nivel
Ideal para preparar Sous vide, marinar platos, almacenar distintos alimentos naturales o cocinados, etc.

Un buen sellado hermético garantiza el sabor, el valor nutricional, la frescura y la protección de los alimentos, aumentando la vida útil entre 2 y 4 veces más

Funcionamiento intuitivo y sencillo

Doble bomba de vacío muy potente, garantiza un vacío óptimo

Ciclo de envasado totalmente automático

Función de sellado continuo

Función marinado, muy útil para ahorrar tiempo frente a los marinados convencionales

Equipada con una barra de sellado extra ancha de 5 mm

Carcasa externa de acero inoxidable, robusta e higiénica

Gracias a su asa en la tapa el envasado al vacío será más cómodo

Bandeja extraíble para pequeñas cantidades de líquidos

Incluye 2 pestañas en su parte posterior para adaptar el soporte para rollo (No incluido)

Se apoya en cuatro pies de goma para una mayor estabilidad

Machine professionnelle d'emballage sous vide, performances de premier ordre
Idéale pour préparer Sous vide, faire mariner des plats, stocker différents aliments naturels ou cuisinés, etc.

Un bon scellage hermétique garantit le goût, la valeur nutritionnelle, la fraîcheur et la protection des aliments, 2 à 4 fois plus de durée de conservation

Fonctionnement simple et intuitif

Pompe à vide double très puissante, assure un vide optimal

Cycle d'emballage entièrement automatique

Fonction de scellage continu

Fonction marinade, très utile pour gagner du temps par rapport aux marinades conventionnelles

Équipée d'une barre de scellage extra large de 5 mm

Carcasse externe robuste et hygiénique en acier inoxydable

Grâce à sa poignée sur le couvercle, l'emballage sous vide sera plus pratique

Plateau pour petites quantités de liquides amovibles

Comprend 2 languettes à l'arrière pour adapter le porte-rouleau (Non inclus)

Quatre pieds en caoutchouc pour une plus grande stabilité

Professionelles Vakuumpackergerät, erstklassige Leistungsfähigkeit

Ideal zum Vakuumgaren, Marinieren, Aufbewahren verschiedener Lebensmittel, ob unbehandelt, gekocht usw.

Ein guter luftdichter Verschluss garantiert Geschmack, Nährwert, Frische und Schutz der Lebensmittel und verlängert ihre Haltbarkeit um das 2- bis 4-fache

Intuitive und einfache Funktionsweise

Doppelte Vakuumpumpe, sehr leistungsfähig

Vollautomatischer Ver- und Verzapfungsvorgang

Durchgehende Verschweißung

Marinierfunktion, ermöglicht Lebensmittel schneller als gewohnt zu marinieren

Extra breiter Schweißbalken, 5 mm

Gehäuse aus Edelstahl, robust und hygienisch

Griff am Deckel erleichtert das Vakuumieren

Herausnehmbarer Einsatz zum Sammeln kleiner Mengen Flüssigkeit

2 Leisten auf der Rückseite zum Justieren des Rollenhalters (nicht imbegriffen)

Vier Gummifüße für bessere Standfestigkeit

Professional vacuum U. Ventsaging machine, top quality features

Ideal to prepare Sous vide, marinate dishes, and store different raw or cooked foods, etc.

A proper airtight seal guarantees the flavour, nutritional value, freshness, and protection of food extending its useful life between 2 and 4 times

Intuitive and simple operation

Very powerful dual vacuum pump, guarantees optimal vacuum

Fully automatic U. Ventsaging cycle

Continuous sealing function

Marinate function, very useful to save time compared to conventional marinating

Equipped with an extra wide 5mm sealing bar

Sturdy and hygienic stainless steel outer housing

The lid handle provides improved comfort for vacuum U. Ventsaging

Tray for small amounts of extractable liquids

Includes 2 tabs on the back to adapt the support for the roll (not included)

Includes four rubber support bases for greater stability

Máquina de embalar a vácuo profissional, com excelentes prestações

Ideal para preparar pratos marinados e "sous vide", para conservar alimentos naturais ou cozinhados, etc.

Uma boa selagem hermética garante o sabor, o valor nutricional, a frescura e a proteção dos alimentos, alargando 2 a 4 vezes a sua vida útil

Funcionamento simples e intuitivo

Dupla bomba de vácuo, de grande potência, para um vácuo perfeito

Ciclo de embalagem totalmente automático

Função de selagem contínua

Função de marinar, para poupar tempo em comparação com os marinados convencionais

Barra de selagem extra larga de 5 mm

Carcasa externa de aço inoxidável, robusta e higiénica

A asa da tampa facilita a embalagem a vácuo

Bandeja extraível para pequenas quantidades de líquidos

2 pestanas na parte posterior para adaptar o suporte pra rolo (não incluído)

Quatro patas de borracha para maior estabilidade

Conserva la calidad, frescor y sabor de los alimentos durante mucho más tiempo

Conserve la qualité, la fraîcheur et la saveur des aliments beaucoup plus longtemps

Bewahrt Qualität, Frische und Geschmack der Nahrungsmittel über eine wesentlich längere Zeit

Preserves the quality, freshness and taste of food for much longer

Conserva a qualidade, a frescura e o sabor dos alimentos durante muito mais tempo



Accesorios

Accessoires - Zubehör - Accessories - Acessórios



Función canister
Canister function

Grado de protección IP20
IP20 degree of protection

Máquina de vacío PROFESIONAL

Machine sous vide
Vakuuiergerät
Vacuum pack machine
Máquina de vacío

Ref	€	W	L (cm)	U.Venta
69530	472,54	700	30	1
69540	523,94	650	40	1

Pestañas para colocar en la máquina de vacío PROFESIONAL
Eyelashes to place in the PROFESSIONAL vacuum machine



Cuchilla interna deslizante, proporciona un corte limpio y preciso
The internal sliding blade makes a clean and precise cut.



Compatible para bobinas hasta:
Compatible for coils up to:
69531 - 30 cm
69541 - 40 cm



Soporte para rollo

Porte-rouleau
Rollenhalter
Roll holder
Suporte de rolo

Ref	€	L (cm)	U.Venta
69531	21,48	30	1
69541	26,15	40	1

Ref	Tensión/Voltage	Potencia/Power	Presión/Pressure	Caudal bomba/Pump flow	L. sellado/Seal length	A. sellado/Seal width	Dimensiones/Sizes	Peso/Weight
69530	220-240 V; 50-60 Hz	700 W	0,9 bar	16 L/min (2 pumps)	31 cm	5 mm	39x27,5x13 cm	6,90 Kg
69540	220-240 V; 50-60 Hz	650 W	0,9 bar	16 L/min (2 pumps)	40 cm	5 mm	49x26x12,5 cm	8,50 Kg



Doble bomba de vacío muy potente, garantiza un vacío óptimo.
Ciclo de envasado automático, 2 niveles de presión automáticos (Gentle y Normal).
Función MARINATE, muy útil para ahorrar tiempo frente a los marinados convencionales.
Función PULSE, para obtener presión de vacío adecuada en el caso de alimentos frágiles (pescado por ejemplo).
3 niveles de tiempo de sellado para distintos tipos de alimentos (secos, húmedos...).
Compartimento para bobinas.

Very powerful dual vacuum pump, guarantees optimal vacuum.
Fully automatic U.Ventaging cycle. Two automatic pressure levels (Gentle and Normal).
MARINATE function, very useful to save time compared to conventional marinating.
PULSE function, to obtain adequate vacuum pressure for fragile foods (fish, for example).
Three levels of sealing time for different types of food (dry, wet, etc.).
Compartment for coil tube.

Barra para corte instantáneo
Bar for instant cutting



Bobina de 28 cm x 5 m (incluida)
28 cm x 5 m coil tube (included)

Orificio para la aspiración de los botes
Opening for the sealing/canisters

Inox

Semiprofessional use

Máquina de vacío EFFICIENT

Machine sous vide
Vakuuiergerät
Vacuum Pack machine
Máquina de vacío

Ref	€	U.Venta
69353	196,50	1

Ref	Tensión/Voltage	Potencia/Power	Presión/Pressure	Caudal bomba/Pump flow	L. sellado/Seal length	A. sellado/Seal width	Dimensiones/Sizes	Peso/Weight
69353	220-240 V; 50 Hz	130 W	0,9 bar	20 L/min (2 pump)	30 cm	2 mm (2)	40x19,4x11 cm	2,90 Kg

▶ MÁQUINAS DE VACÍO DOMÉSTICAS

- Household use -

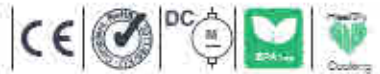

Envasadora al vacío doméstica y compacta, perfecta para uso diario. Ideal para el almacenamiento de alimentos a largo plazo, aumentando la vida útil entre 2 y 4 veces más y conservando el sabor, el valor nutricional y la frescura. Perfecta para alimentos crudos y cocinados. Funcionamiento intuitivo y sencillo.

Tres funciones disponibles:

- 1) Función de sellado de bolsa.
- 2) Función automática, perfecta para conservar alimentos secos y duros (semillas, granos de café, frutos secos, pasta, hortalizas duras, etc.).
- 3) Función manual, cuando queremos conservar alimentos frágiles como pescados, frutas, champiñones, pan, bizcochos, etc.

Contiene un orificio para la aspiración de los botes.

Scelleuse sous-vide domestique et compacte, parfaite pour une utilisation quotidienne, idéale pour conserver des aliments à long terme, augmentant de 2 à 4 fois leur vie utile tout en conservant leur goût, la valeur nutritionnelle et la fraîcheur. Parfaite pour des aliments crus et cuisinés.

Funcionamiento intuitivo y simple.

Funciones posibles:

- 1) Función de sellado de bolsa.
- 2) Función automática, perfecta para conservar alimentos secos y duros (granos de café, frutos secos, pasta, legumbres, etc.).
- 3) Función manual, para guardar los alimentos más frágiles como el pescado, los frutos, los champiñones, el pan, los bizcochos, etc.

Contiene un orificio para aspirar los botes.

Kompakter Haushaltsvakuumierer, perfekt für den täglichen Gebrauch. Ideal für die langfristige Aufbewahrung von Lebensmitteln. 2- bis 4-fache Verlängerung der Haltbarkeit unter Beibehaltung von Geschmack, Nährwert und Frische.

Perfekt für rohe und gekochte Lebensmittel.

Intuitive, einfache Handhabung.

Drei Funktionen:

- 1) Beutelversiegelung.
- 2) Automatikbetrieb, perfekt für die Aufbewahrung von trockenen, harten Lebensmitteln (Samen, Kaffeebohnen, Trockenfrüchte, Nudeln, harte Gemüsesorten usw.).
- 3) Manuelle Betätigung für die Konservierung empfindlicher Produkte wie Fisch, Obst, Champignons, Brot, Kuchen usw.

Mit Öffnung zum Absaugen von Vakuumbehältern.

Compact vacuum packing machine, perfect for daily home use. Ideal for long-term storage of food, making shelf-life up to about 2 to 4 times more while preserving the flavour, nutritional value and freshness. Perfect for raw and cooked foods.

Intuitive and simple operation.

There are three functions available:

- 1) Bag sealing function.
- 2) Automatic, ideal function for preserving dry and hard foods (seeds, coffee beans, nuts, pasta, hard vegetables, etc.).
- 3) Manual function, for preserving fragile food like fish, fruits, mushrooms, bread, biscuits, etc.

A hole for drawing out air from canisters.

Máquina de selar a vácuo doméstica e compacta, perfeita para uso diário. Ideal para o armazenamento de alimentos a longo prazo, aumentando a vida útil entre duas a quatro vezes mais e conservando o sabor, o valor nutricional e a frescura. Perfeita para alimentos crus e cozinhados.

Funcionamento intuitivo e fácil.

Tem três funções disponíveis:

- 1) Função de selagem do saco.
- 2) Função automática, perfeita para conservar alimentos secos e duros (sementes, grãos de café, frutos secos, massa, legumes duros, etc.).
- 3) Função manual, quando queremos conservar produtos frágeis como peixe, frutas, cogumelos, pão, bolos, etc.

Contém um orifício para a aspiração das embalagens.



Orificio para la aspiración de los botes
Opening for the sealing of canisters

Inox

Máquina de vacío SLIM

Machine sous vide
Vakuumiergerät
Vacuum pack machine
Máquina de vácuo

Ref	€	W	U.Venta
69354	69.72	80	1



Ref	Tensión/Voltage	Potencia/Power	Presión/Pressure	Caudal bomba/Pump flow	L. sellado/Seal length	A. sellado/Seal width	Dimensiones/Sizes	Peso/Weight
69354	220-240 V; 50 Hz	80 W	0,5 bar	5 L/min (1 pump)	30 cm	2 mm	38,4x9,7x5,7 cm	1,00 Kg

Con orificio para la aspiración de los botes
With opening for the sealing of canisters



Incluye 10 bolsas de vacío (20x30 cm)
Includes 10 vacuum bags (20x30 cm)

Incluye 10 bolsas de vacío
5 de 20x30 cm y 5 de 28x40 cm
Includes 10 vacuum bags
20x30 cm (5) / 28x40 cm (5)



Máquina de vacío HOME

Machine sous vide
Vakuuiergerät
Vacuum pack machine
Máquina de vacío

Ref	€	W	U.Venta
69050	94,21	110	1

Máquina de vacío LUXE

Machine sous vide
Vakuuiergerät
Vacuum pack machine
Máquina de vacío

Ref	€	W	U.Venta
69151	106,76	120	1

Ref	Tensión/Voltage	Potencia/Power	Presión/Pressure	Caudal bomba/Pump flow	L. sellado/Seal width	Dimensiones/Sizes	Peso/Weight
69050	220-240 V, 50 Hz	110 W	0,8 bar	9 l/min	28 cm (max)	35,7x14,8x8,7 cm	1,40 Kg
69151	220-240 V, 50 Hz	120 W	0,4 - 0,8 bar	9 l/min	30 cm (max)	37x14,4x7,4 cm	1,55 Kg



Sella herméticamente los alimentos aumentando de 3 a 5 veces más tiempo su durabilidad

Expulsa el aire y la humedad, manteniendo sus sabores y nutrientes

Hermetically seals the food, increasing its shelf life by 3 to 5 times.
Expels air and moisture, maintaining the food's flavors and nutrients



Máquina de vacío MAXI

Machine sous vide
Vakuuiergerät
Vacuum pack machine
Máquina de vacío

Ref	€	W	U.Venta
69350	131,04	120	1



Posibilidad de realización de bolsas

Bobina incluida - 22 cm x 3 m

Possibility of making bags

Coil tube included - 22 cm x 3 m

Orificio para la aspiración de los botes

Opening for the sealing of canisters

Ref	Tensión/Voltage	Potencia/Power	Presión/Pressure	Caudal bomba/Pump flow	L. sellado/Seal length	A. sellado/Seal width	Dimensiones/Sizes	Peso/Weight
69350	220-240 V, 50/60 Hz	120 W	0,6 - 0,8 bar	12 l/min	30 cm	3 mm	43,5x21x10 cm	2,05 Kg



Sella herméticamente los alimentos aumentando de 3 a 5 veces más su durabilidad. Expulsa el aire y la humedad, manteniendo sus sabores y nutrientes. Panel de control táctil, 2 niveles de envasado al vacío: alimentos húmedos y secos. Bandeja para recoger líquidos en la parte posterior de la máquina. Gracias a su diseño vertical ocupa poco espacio.

Scellage hermétique des aliments, augmentant ainsi de 3 à 5 fois leur durabilité. Expulse l'air et l'humidité, en conservant leurs saveurs et leurs nutriments. Tableau de contrôle tactile, 2 niveaux de conditionnement sous vide: aliments humides et aliments secs. Plateau pour recueillir les liquides dans la partie arrière de la machine. Prend moins de place grâce à sa conception verticale.

Versiegelt die Nahrungsmittel luftdicht, und verlängert deren Haltbarkeit um das 3- bis 5-fache. Es werden Luft und Feuchtigkeit abgetrennt und der Geschmack sowie die Nährstoffe bewahrt. Sensorbedientfeld, 2 Vakuumsäufen: feuchte und trockene Nahrungsmittel. Auffangwanne für Flüssigkeiten auf der Rückseite des Geräts. Dank des vertikalen Designs platzsparend.

Hermetically seals the food, increasing its shelf life by 3 to 5 times. Expels air and moisture, maintaining the food's flavours and nutrients. Touch control panel, 2 levels of vacuum packaging: moist and dry foods. Liquid collection tray on the back of the machine. Takes up little space thanks to its vertical design.

Sella herméticamente os alimentos, aumentando de 3 a 5 vezes a sua validade. Expulsa o ar e a humidade, conservando os sabores e os nutrientes. Painel de controlo tátil, 2 níveis de embalagem em vácuo: alimentos húmidos e secos. Bandeja para recolher líquidos na parte posterior da máquina. O seu desenho vertical economiza espaço.

Conserva la calidad, frescor y sabor de los alimentos durante mucho más tiempo

Preserves the quality, freshness and taste of food for much longer



El mejor sellado para alimentos tanto húmedos como secos
Le meilleur scellage pour les aliments aussi bien humides que secs.
Die beste Versiegelung sowohl für feuchte als auch trockene Nahrungsmittel.
The best seal for both moist and dry food.
A melhor selagem para alimentos, húmidos e secos.



Compartimento para líquidos
Compartment pour liquides.
Abteil für Flüssigkeiten.
Compartment for liquids.
Compartimento para líquidos.

Incluye:
5 bolsas de 20x30cm
Bobina de 20cmx2m
Tubo canister de 40 cm de largo
Includes:
5 20x30cm bags
20cmx2m coil tube
40 cm-long canister hose

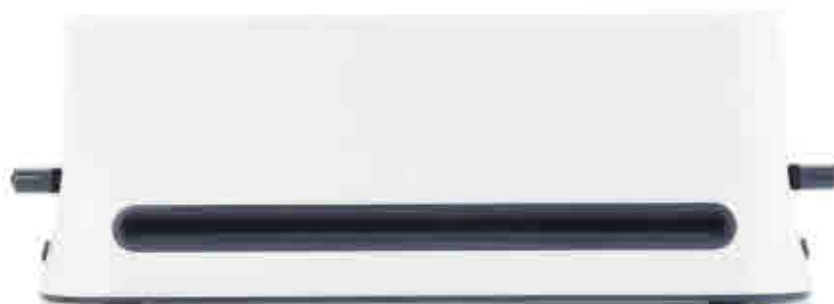

Orificio para la aspiración de los botes
Opening for the sealing of canisters



Máquina de vacío EXTREME

Machine de conditionnement sous vide
Vakuummiergerät
Vacuum machine
Máquina de vácuo

Ref	€	W	U.Venta
69355	127,09	110	1

Ref	Tensión/Voltage	Potencia/Power	Presión/Pressure	Cap. bomba/Pump Cap.	L. Sellado/Seal	Dimensiones/Sizes	Peso/Weight
69355	220-240 V, 50 Hz	110 W	0.8 bar	12 L/min	30 cm (W=2,5 mm)	42x9,5x15 cm	1,70 Kg

► BOLSAS · BOBINAS · BOTES VACIO



Apto para uso alimenticio.
Recomendada para uso con máquina de vacío de la marca LACOR.
No se recomienda su reutilización tras el uso con carnes, pescados y otros alimentos deteriorables, tan solo tras el uso en productos secos, legumbres, frutos secos, etc.

Adaptée au conditionnement de denrées alimentaires.
 Recommandée pour être utilisée avec la machine à emballer sous vide LACOR.
 Son utilisation est déconseillée pour reconditionner de la viande, du poisson et d'autres denrées alimentaires périssables. Elle peut être réutilisée pour reconditionner des fruits secs, des légumes, des fruits secs, etc.

Lebensmittelgeprüft.
 Empfohlen für den Einsatz mit Vakuurgerät der Marke LACOR.
 Nicht empfohlen wird die Wiederverwendung nach Verwendung für Fleisch, Fisch und sonstigen verderblichen Lebensmittel. Wiederverwendung nur nach Verwertung für trockene Produkte, Hülsenfrüchte, Trockenfrüchte etc.

Suitable for use with food.
 Recommended for use with vacuum packet of the LACOR brand.
 Not recommended to be reused after use with meals, fish and other fresh foods, only after use with dried products, pulses, nuts, etc.

Adequado para uso de alimentos.
 Recomendado para usar com máquina de vácuo da marca LACOR.
 Não recomendado para reutilização após a utilização com carnes, peixes e outros alimentos perecíveis; somente após a utilização em produtos secos, legumes, nozes, etc.



Bobina tubo vacío
 Bobine de tube
 Vakuumbbeutel Rollen
 Coil tube
 Bobina manga



Ref	€	Bobina	Micras	U.Venta
69052	12.14	28cmx5m	105	1
69057	8.20	14cmx10m	105	6
69059	11.41	22cmx10m	105	1
69058	14.84	28cmx10m	105	1
69451	16.70	40cmx10m	105	1
69259	7.68	28cmx5m	105	1
69458	9.86	28cmx5m	90	1
69459	7.89	22cmx5m	90	6
69462	8.30	28cmx5m	105	1
69463	7.37	22cmx10m	105	1
69464	9.23	28cmx10m	105	1

Lisas
 Flat

Bolsas vacío
 Sacs de conservation sous vide
 Vakuumbbeutel, 100 Stück
 Vacuum bags
 Sacos de vácuo

Ref	€	Bolsa	Unidades	Micras	U.Venta
69053	4.36	16x20	25	105	6
69054	7.47	20x30	25	105	6
69055	10.06	24x36	25	105	1
69056	12.66	28x40	25	105	1
69042	27.70	20x30	100	105	1
69046	40.46	25x35	100	105	1
69047	55.09	30x40	100	105	1
69048	110.60	40x60	100	105	1
69453	5.19	16x20	25	90	6
69454	9.44	20x30	25	90	1
69455	13.28	24x36	25	90	1
69460	4.77	20x30	25	105	1
69461	8.72	28x40	25	105	1

Lisas
 Flat



Ideal para embutidos
 Ideal for sausages



Bobina tubo vacío
 Bobine de tube
 Vakuumbbeutel Rollen
 Coil tube
 Bobina manga

Ref	€	Bobina	Micras	U.Venta
69452	5.19	12 cm x 10 m	105	6

















Set 3 botes vacío hogar + adaptador
 3 boîte sous vide + Adaptateur
 3 Vakuumb-Behälter Set + Adapter
 3 Shape canister set + Adapter
 Con. 3 caixas vácuo domésticas + Adaptador



Ref	€	L	U.Venta
69051	31.23	0,7-1,4-2,0	1

Máquina de vacío / Vacuum Pack machine

			69116	69352	69530	69540	69353	69050	69151	69350	69354	69355	
													
ROLLO · COIL TUBE 	69052	22x10cmx22cmx10m	Gofrada	✓	✓	✓	✓	✓	✓	✓	✓	✓	
	69057	14cmx10m	Gofrada	✓	✓	✓	✓	✓	✓	✓	✓	✓	
	69059	22cmx10m	Gofrada	✓	✓	✓	✓	✓	✓	✓	✓	✓	
	69058	28cmx10m	Gofrada	✓	✓	✓	✓	✓	✓	✓	✓	✓	
	69451	40cmx10m	Gofrada	✓	✓	✓	✓	✓	✓	✓	✓	✓	
	69259	28cmx5m	Gofrada	✓	✓	✓	✓	✓	✓	✓	✓	✓	
	69458	28cmx5m	Gofrada	✓	✓	✓	✓	✓	✓	✓	✓	✓	
	69459	22cmx5m	Gofrada	✓	✓	✓	✓	✓	✓	✓	✓	✓	
	69462	22cmx5m	Lisa	✓	✓								
	69463	22cmx10m	Lisa	✓	✓								
	69464	28cmx10m	Lisa	✓	✓								
	BOLSAS · BAGS 	69053	16x20	Gofrada	✓	✓	✓	✓	✓	✓	✓	✓	✓
		69054	20x30	Gofrada	✓	✓	✓	✓	✓	✓	✓	✓	✓
69055		24x36	Gofrada	✓	✓	✓	✓	✓	✓	✓	✓	✓	
69056		28x40	Gofrada	✓	✓	✓	✓	✓	✓	✓	✓	✓	
69042		20x30	Gofrada	✓	✓	✓	✓	✓	✓	✓	✓	✓	
69046		25x35	Gofrada	✓	✓	✓	✓	✓	✓	✓	✓	✓	
69047		30x40	Gofrada	✓	✓	✓	✓	✓	✓	✓	✓	✓	
69453		16x20	Gofrada	✓	✓	✓	✓	✓	✓	✓	✓	✓	
69454		20x30	Gofrada	✓	✓	✓	✓	✓	✓	✓	✓	✓	
69455		24x36	Gofrada	✓	✓	✓	✓	✓	✓	✓	✓	✓	
69460		20x30	Lisa	✓	✓								
69461		28x40	Lisa	✓	✓								
69048(*)		40x60	Gofrada	✓	✓	✓	✓	✓	✓	✓	✓	✓	
BOLINA EMBUTIDOS COIL TUBE FOR SAUSAGE IS 	69452	12cmx10m	Gofrada	✓	✓	✓	✓	✓	✓	✓	✓	✓	
SET 3 BOTES VACIO 3 SHAPE CANISTER SET 	69051	0,7 - 1,4 2.0 L			✓	✓	✓	✓	✓	✓	✓	✓	

(*) Apta para la máquina de vacío 69040 (descatalogada)

■ Bolsas y rollos para uso exclusivo del SOUS VIDE

SOUS VIDE



**Técnica culinaria que prima la calidad del producto.
Resultados sorprendentes; alimentos más jugosos, tiernos y succulentos.
Preserva las cualidades del producto y realza su sabor y textura.**

Technique culinaire qui privilégie la qualité du produit.
Résultats surprenants; aliments plus juteux, tendres et succulents.
Préserve les qualités du produit et améliore sa saveur et sa texture.

Kochmethode zur Verfeinerung von Gargut.
Lebensmittel sind erstaunlich saftig, zart und geschmackhaft.
Erhält die Eigenschaft des Produkts und verbessert seinen Geschmack und seine Textur.

Culinary technique that enhances the quality of the product.
Amazing results; juicier, more tender and more succulent too.
Preserves the qualities of the product and enhances its flavour and texture.

Técnica culinária que preserva a qualidade do produto.
Resultados surpreendentes: alimentos mais ternos e succulentos.
Preserva as qualidades do produto e aprimora seu sabor e textura.



Cocinando paso a paso...



Sazonamos los alimentos a cocinar
Assaisonner les aliments à cuisiner
Gargut würzen
Season the ingredients for cooking
Condimentamos os alimentos a cozinhar



Envasamos al vacío los alimentos
Conditionner les aliments sous vide
Gargut vakuumverpacken
Vacuum pack the ingredients
Embalamos os alimentos em vácuo



Llenamos una olla con agua
Remplir une marmite d'eau
Topf mit Wasser füllen
Fill a cooking pot with water
Enchamo uma panela com água



Programamos el tiempo y la temperatura
Programmer la durée et la température
Garzeit und -temperatur einstellen
Programme in the time and the temperature
Programamos o tempo e a temperatura





Esperamos a que emita un pitido
Attendre l'émission d'un signal sonore
Pföhlön abwarten
Wait for the beep
Esperamos que emita um aviso sonoro



Introducimos la bolsa dentro de la olla
Introduire le sachet dans la marmite
Vakuumbbeutel in den Topf geben
Place the bag into the pot
Introduzimos o saco com os alimentos dentro da panela



Retiramos la bolsa y ¡A disfrutar!
Retirer le sachet et, bonne dégustation!
Vakuumbbeutel entnehmen - Guten Appetit!
Remove the bag and... Enjoy!
Retiramos o saco... e a desfrutar!

SOUS VIDE	CIRCULACIÓN CIRCULATION	CAUDAL BOMBA PUMP FLOW	VOLUMEN (máx) VOLUME (max)	POTENCIA POWER	TEMPERATURA TEMPERATURE	DESVIACIÓN DESVIATION	ALT. MIN. DE AGUA MIN. WATER HEIGHT
 69192	BOMBA PUMP	6 L/min	40 L	1500 W	5°C - 99°C	0,1°C	12 cm
 69304	BOMBA PUMP	4,5 L/min	30 L	1200 W	5°C - 99°C	0,1°C	11 cm
 69302 - 69303	EJE VENTILADOR FAN SHAFT	N/A	15 L	1200 W	20°C - 90°C	1°C	6 cm

Características de nuestros SOUS VIDE portátiles:

- Resistencia de calentamiento:** Elemento encargado de calentar el agua. Cuanto mayor es la potencia de la resistencia, mayor es la capacidad de calentamiento del agua y menor el tiempo de espera hasta alcanzar la temperatura programable.
- Estabilidad de la temperatura:** Cuanto mayor sea la capacidad de la bomba (L/min), mayor será la estabilidad de la temperatura en el recipiente.
- Resolución:** Escalado de la temperatura a la que se puede programar el agua.
- Desviación de la temperatura:** La máxima diferencia entre temperatura programada y la temperatura del agua.
- Grado de protección contra el agua:** Grado de protección IPX7 frente a inmersiones temporales en agua. Esto garantiza que el aparato acepta la inmersión a 1 metro de profundidad durante 30 minutos sin que sea un peligro ni para el propio artículo ni para el usuario.

Caractéristiques de nos SOUS VIDE portables

- Résistance de chauffe:** Élément chargé de chauffer l'eau. Plus la puissance de la résistance est importante, plus la capacité de chauffe de l'eau est grande et moins le temps d'attente pour atteindre la température programmable est long.
- Stabilité de la température:** Plus la capacité de la pompe est grande (L/min), plus la stabilité de la température dans le récipient sera importante.
- Résolution:** Progression de la température à laquelle peut être programmée l'eau.
- Écart de la température:** La différence maximale entre la température programmée et la température de l'eau.
- Degré de résistance à l'eau:** Degré de protection IPX7 face à des immersions temporaires dans l'eau. Cela garantit que l'appareil est étanche à 1 mètre de profondeur pendant 30 minutes sans que cela ne représente un danger ni pour l'appareil ni pour l'utilisateur.

Merkmale unserer tragbaren Vakuumgarer:

- Heizwiderstand:** Erhitzt das Wasser. Je größer die Widerstandsleistung, desto größer ist die Heizkapazität und desto kürzer die Wartezeit, bis die voreingestellte Temperatur erreicht wird.
- Temperaturkonstanz:** Je größer die Pumpenkapazität (l/min) desto höher ist die Temperaturkonstanz im Behälter.
- Skalierung:** Temperaturskala für die mögliche Voreinstellung der Wassertemperatur.
- Temperaturabweichung:** Die maximale Differenz zwischen voreingestellter Temperatur und Wassertemperatur.
- Wasserschutzklasse:** Schutzklasse IPX7 gegen Eindringen von Wasser beim kompletten Eintauchen für begrenzte Zeit. D. h. das Gerät lässt sich sicher für 30 Minuten 1 Meter tief eintauchen, ohne dass dadurch für den Anwender oder das Gerät eine Gefahr besteht.

Characteristics of our portable SOUS VIDE

- Heating element:** Component that heats the water. The greater the power of the heating element, the greater capacity it has for heating water and the less time you have to wait for the water to reach the programmable temperature.
- Temperature stability:** The greater the capacity of the pump (L/min) the better the temperature stability in the container.
- Resolution:** Scale of the temperatures the water can be programmed to.
- Temperature variation:** The maximum difference between the programmed temperature and the water temperature.
- Level of waterproofing protection:** IPX7 level protection against temporary immersion in water. This guarantees that the device can withstand being immersed 1 metre deep for 30 minutes with no risk to the device or the user.

Características dos nossos SOUS VIDE portáteis:

- Resistência de aquecimento:** Elemento destinado a aquecer a água. Quanto maior for a potência da resistência, maior a capacidade de aquecimento da água, e menor o tempo de espera até alcançar a temperatura programável.
- Estabilidade da temperatura:** Quando maior for a capacidade da bomba (litros/min), maior a estabilidade da temperatura no recipiente.
- Resolução:** Escala de temperatura segundo a qual se pode programar a temperatura da água.
- Desvio da temperatura:** Diferença máxima entre a temperatura programada e a temperatura da água.
- Grau de proteção contra a água:** Grau de proteção IPX7 contra a imersão temporária em água, que garante que o aparelho suporta a imersão a 1 metro de profundidade durante 30 minutos sem que tal represente qualquer perigo para o aparelho ou para o utilizador.



Bomba
La circulación mejora y garantiza una distribución uniforme del agua y la estabilidad de la temperatura

Pump
Circulation improves and ensures uniform water distribution and temperature stability

Inox
18/10

Professional use

Sous Vide PRO

Sous Vide
Sous Vide
Sous Vide
Sous Vide



Protection Against
Temporary immersion



Su diseño compacto hace que sea fácilmente almacenable y transportable. Se sujeta a cualquier tipo de olla, cacerola o cubeta que pueda contener 40 L.

Seu concepção compacta faz com que seja fácil de armazenar e de transportar. Se fixa em qualquer tipo de panela, cacerola ou recipiente que possa conter 40 L.

Se fixe sur tout type de casserole, de marmite ou de cuve pouvant contenir 40 L.

Auf Grund des kompakten Designs ist das Gerät einfach zu lagern und zu transportieren. Kann an Töpfe, Kasserollen oder Behälter mit 40 l Fassungsvermögen befestigt werden.

Its compact design makes it easy to store and transport. It is attached to any type of pot, saucepan or tray that can contain 40 L.

O seu desenho compacto faz com que seja fácil de armazenar e de transportar. Sujeta-se a qualquer tipo de panela, cacerola ou recipiente que possa conter 40 L.

Ref	€	W	U.Venta
69192	401,82	1500	1

Ref	Tensión/Voltage	Potencia/Power	Caudal bomba/Pump flow	Temperat./Temp.	Precisión/Precision	Capacidad/Cap.	Dimensiones/Sizes	Peso/Weight
69192	220-240 V; 50/60 Hz	1500 W	6 L/min.	5 - 99°C	0,1°C	40 L	14x14x33 cm	1,93 Kg



Bomba:
La circulación mejora y garantiza una distribución uniforme del agua y la estabilidad de la temperatura

Pump
Circulation improves and ensures uniform water distribution and temperature stability

Inox
18/10

Semiprofessional use

Sous Vide PRECISE

Sous Vide
Sous Vide
Sous Vide
Sous Vide



Diseño compacto, anclaje sencillo y fácilmente almacenable y transportable. Se sujeta a cualquier tipo de olla, cacerola o cubeta que pueda contener 30 L.

Concepção compacta, anclagem simples e fácil de armazenar e de transportar. Se fixa em qualquer tipo de panela, cacerola ou recipiente que possa conter 30 L.

Platzsparendes Design, leicht zu fixieren, gut verstau- und transportierbar. Kann an Töpfe, Kasserollen oder Behälter mit 30 l Fassungsvermögen befestigt werden.

Compact design, simple fastening and easy to store and transport. It is attached to any type of pot, saucepan or tray that can contain 30 L.

Desenho compacto, fixação simples e fácil de armazenar e de transportar. Sujeta-se a qualquer tipo de panela, cacerola ou recipiente que possa conter 30 L.

Ref	€	W	U.Venta
69304	267,16	1200	1

Ref	Tensión/Voltage	Potencia/Power	Velocidad/Speed	Temperat./Temp.	Capacidad/Cap.	Temp./Timer	Dimensiones/Sizes	Peso/Weight
69304	220-240 V; 50/60 Hz	1200 W	4,5 L/min.	5°C-99°C (Precision 0,1°C)	30 L	99 h	8x16x33 cm	1,40 Kg



Soft Touch
Soft Touch



Pantalla táctil
Touchscreen



Fácil anclaje
Easy to attach



Regulador Led
LED controller



Circulador de agua
Water circulator



Fácil limpieza
Easy to clean



Protection Against
Temporary immersion



Inox
18/10

Household use

Sous Vide GOURMET

Sous Vide
Sous Vide
Sous Vide
Sous Vide

Ref	€	W	U.Venta
A 69302	176.48	800	1
B 69303	176.48	800	1



Incluye Recetario
Recipe Book included

Por Miriam Garcia (invitadoinvierno.com) en exclusiva para Lacor
By Miriam Garcia (invitadoinvierno.com) exclusively for Lacor

Ref	Tensión/Voltage	Potencia/Power	Temperature/Temp.	Capacidad/Capacity	Dimensiones/Sizes	Peso/Weight
69302	220-240 V; 50/60 Hz	1200 W	20-90°C (1°C)	15 L	Ø10x37 cm	1,0 Kg
69303	220-240 V; 50/60 Hz	1200 W	20-90°C (1°C)	15 L	Ø10x37 cm	1,0 Kg

SOUS VIDE CON TAPA

Semiprofessional use



Sous Vide

Sous Vide
Sous Vide
Sous Vide
Sous Vide

Ref	€	W	L	U.Venta
69193	625.85	620	11 - 12,5	1



Se emplean bolsas herméticas que se sumergen en el agua caliente por debajo del punto de ebullición.

Pantalla táctil: Tiempo, temperatura, inicio y stop.

Des sachets hermétiques sont utilisés pour immerger les aliments dans l'eau chaude en-deçà du point d'ébullition, soit environ.
Écran tactile : heure, température, start et stop.

Es werden dicht abschließende Beutel verwendet, die in das heiße Wasser eingetaucht werden, unterhalb des Siedepunkts.
Touchscreen: Zeit, Temperatur, Start und Stop.

Uses hermetically sealed bags that are submerged into hot water below boiling point.
Touch screen: time, temperature, start and stop.

Utiliza bolsas herméticas, que se podem mergulhar em água quente abaixo do ponto de ebulição.
Tela de toque: tempo, temperatura, start e stop.



Ref	Tensión/Voltage	Potencia/Power	Caudal bomba/Pump flow	Temperat./Temp.	Precisión/Precision	Capacidad/Cap.	Dimensiones/Sizes	Peso/Weight
69193	220-240 V; 50/60 Hz	620 W	6 L/min	5 - 99°C	0,1°C	11 - 12,5 L	27x29x42 cm	6,30 Kg

▶ REJILLA PARA SOUS VIDE

Professional use



Ideal para la sujeción en vertical de 4 bolsas
Its design is ideal for holding 4 vacuum bags



Rack para SOUS VIDE

Rack pour Sous Vide

Rack für Sous Vide

Rack for sous vide

Cremaheira para sous Vide

Ref	€	cm	Ø Varilla (mm)	U.Venta
67051	13,70	20x13,5x13,5	4	1

Inox
18/10

Su diseño es ideal para la sujeción en vertical de 4 bolsas de vacío. Evita que las bolsas floten y entren en contacto con las paredes o fondo de las cubetas.

Permite la circulación del agua entre las bolsas en todo momento, consiguiendo una cocción uniforme.

Permite introducir y retirar las bolsas con facilidad.

Se forme est idéale pour faire tenir à la verticale 4 sachets pour sous vide. Évite que les sachets flottent et entrent en contact avec les parois ou le fond des cuves.

Permet la circulation constante de l'eau entre les sachets, obtenant ainsi une cuisson uniforme.

Permet d'introduire et de retirer les sachets plus facilement et rapidement.

Ideale Form für die senkrechte Fixierung von 4 Vakuumbeuteln. Beutel bleiben unter Wasser und kommen nicht mit Wand oder Boden von Behältern in Kontakt.

Ermöglicht die dauernde Wasserzirkulation zwischen den Beuteln und erzielt dadurch einen gleichmäßigen Kochvorgang. Vereinfacht das Einfügen und Entnehmen von Beuteln.

Its design is ideal for holding 4 vacuum bags vertically

Prevents bags from floating and coming into contact with the sides or bottom of the container

Enables water to flow between the bags at all times, resulting in even cooking. Makes it quicker and easier to insert and remove the bags.

Design ideal para soportar na vertical 4 sacos para cocção a vácuo.

Evita que os sacos flutem e entrem em contacto com as paredes ou com o fundo dos recipientes.

Permite a circulação da água entre os sacos em todo o momento, para uma cocção uniforme.

Permite introduzir e retirar facilmente os sacos.

▶ BOLAS AISLANTES PARA SOUS VIDE

Professional use

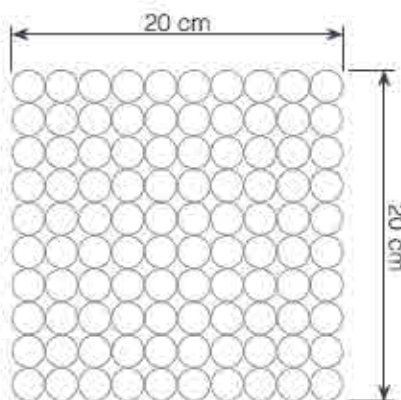

Área para 100 bolas (22 cm) es de 400 cm²
The area for 100 balls (22 cm) is 400 cm²



Bolas aislantes huacas y flotantes de polipropileno (PP), libres de BPA, para dispositivos sous-vide.

Crean una capa de aislamiento evitando la pérdida de calor en un 75% y en un 90% la evaporación del agua.

Permiten hervir agua durante horas sin tener que echar más, gracias al mínimo contacto entre agua y aire.

Aumentan la precisión de la temperatura y ayudan a mantener los envasados al vacío bajo el agua.

Reducen humos y riesgos de salpicaduras.

Soportan hasta 150°C sin ningún problema.

Compatibles con recipientes de todas las formas y tamaños.

Se presenta con una práctica malla con cierre de cordón.

Hollow, floating, BPA-free polypropylene (PP) insulation balls for sous vide devices.

Create an insulation layer reducing heat loss by 75% and water evaporation by 90%.

Enable you to boil water for hours without having to add more, thanks to the minimal contact between water and air.

Increase temperature accuracy and help keep vacuum packs submerged. Reduce smoke and the risk of splashes.

Withstand up to 150°C without any problem.

Compatible with containers of all shapes and sizes.

Come with a handy mesh drawstring bag.



Perfecta capa de aislamiento
Perfect insulation layer

Bolas aislantes para Sous Vide

Billes isolantes p'appareils de conditionnement Sous-Vide

Isolationskugeln für Sous-Vide

Sous Vide Insulation Balls

Esfemas isolantes para Sous Vide

Ref	€	Ø (cm)	Unidad	U.Venta
69219	24,28	2,0	100	1



Diseñada para refrigerar eficazmente botellas de vino y otras bebidas. La temperatura interior puede ser ajustada mediante el control electrónico. Destaca por su elegante diseño y por su control táctil de temperatura. Incorpora una práctica luz interior. Deje suficiente espacio en la parte trasera (mínimo 5 cm) para permitir la salida del calor y una adecuada ventilación.

Conçus pour réfrigérer efficacement les bouteilles de vin et autres boissons. La température intérieure peut être réglée à l'aide du contrôle électronique. Elle se distingue par son design élégant et son contrôle de température tactile. Dispose d'un éclairage intérieur très pratique. Laissez suffisamment d'espace dans la partie arrière (minimum 5 cm) pour permettre la sortie de la chaleur et une bonne ventilation.

Für die leistungsstarke Kühlung von Wein und anderen Getränken. Die Innentemperatur lässt sich elektronisch einstellen. Besonders durch elegantes Design und touchfähige Temperaturregelung ausgezeichnet.

Mit praktischer Innenbeleuchtung

Zur Gewährleistung der Wärmeabstrahlung und Belüftung genügend Abstand (5 cm) zur Wand halten.

Designed to effectively cool bottles of wine and other beverages. The internal temperature can be adjusted using the electronic control. Stands out thanks to its elegant design and fingertip temperature control. Incorporates a practical interior light.

Leave enough space at the back (minimum 5 cm) to allow heat to escape and adequate ventilation.

Desenhado para refrigerar eficazmente garrafas do vinho e outras bebidas. Controlo electrónico regulável da temperatura interior. Destaca-se pelo seu design elegante e pelo controlo tátil da temperatura. Incorpora uma prática luz interior. Recomendamos deixar um espaço suficiente entre o armário e a parede de trás (mínimo de 5 cm) para permitir a saída do calor e uma ventilação adequada.



DISPLAY



Armario refrigerador de compresor

Refridisseur à vin à compresseur

Weinkühler mit Kompressor

Compressor type winw cooler

Refrigerador de vinho do tipo compresor

Ref	€	Botellas	U.Venta
69238	393.73	28	1



New

Ref	Tensión/Voltage	Botellas/Bottles	Potencia/Power	Temperatura/Temp.	Consumo Consump.	Ruido/Noise	Dimensiones/Sizes	Peso/Weight
69238	220-240 V ; 50/60 Hz	28	85 W	5°C-18°C	189 kWh/annum	42 dB	43x45x84 cm	24 Kg



Doble cámara - Double camera



Display temperatura - Temperature display

Control de temperatura (+/-) - Temperature touch control

Control de luz (ON/OFF) - Light control (ON/OFF)

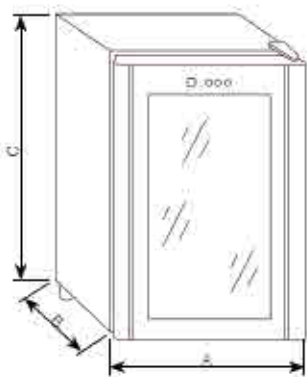

Armarios refrigeradores BLACK

Réfrigérateur à vin

Thermo Weinkühler

Thermo wine cooler

Armário refrigerador

	Ref.	€	U.Venta
A	69178	209,16	1
B	69171	289,46	1
C	69175	320,28	1
D	69187	209,16	1
E	69186	265,81	1
F	69185	355,14	1
G	69184	774,29	1

Doble cámara - Double camera

Doble cámara - Double camera



Doble cámara - Double camera



Ref.	Tensión/Voltage	Botellas/Bottles	Potencia/Power	Capacidad/Cap.	Temperatura/Temp.	Consumo/Consump.	Dimensiones/Sizes x x x x cm	Peso/Weight
69178	220-240 V, 50/60 Hz	8	50 W	23 L	8 - 18°C	162 kWh/annum	28x51,5x47 cm	9,40 Kg
69171	220-240 V, 50/60 Hz	18	70 W	48 L	12 - 18°C	171 kWh/annum	38x50x65 cm	14,84 Kg
69175	220-240 V, 50/60 Hz	28	70 W	65 L	12 - 18°C	182 kWh/annum	48x54x74cm	19,3 Kg
69187	220-240 V, 50/60 Hz	8	70 W	23 L	8 - 18°C	183 kWh/annum	42x28,5x50,5 cm	8,0 Kg
69186	220-240 V, 50/60 Hz	16	70W	46 L	12 - 18°C	189 kWh/annum	44x48x51 cm	15,5 Kg
69185	220-240 V, 50/60 Hz	18	100 W	46 L	8 - 18°C / 12 - 18°C	197 kWh/annum	36x50x65 cm	16,0 Kg
69184	220-240 V, 50/60 Hz	48	180 W	140 L	10 - 18°C / 12 - 18°C	297 kWh/annum	70x52x85 cm	41,5 Kg

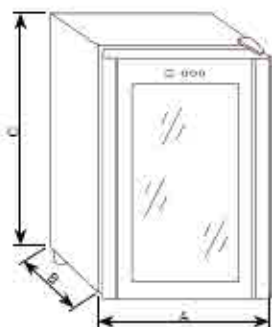

Control electrónico de temperatura
Puerta inoxidable
Luz en el interior

Electronic temperature control
Rust-proof door
Light inside



Armarios refrigeradores INOX

Refrigerateur à vin
Thermo Weinkühler
Thermo wine cooler
Armario refrigerador

	Ref	€	U. Venta
A	69078	225,97	1
B	69071	268,51	1
C	69072	349,02	1

Ref	Tensión/Voltage	Botellas/Bottles	Potencia/Power	Capacidad/Cap.	Temperatura/Temp.	Consumo/Consump.	Dimensiones/Size A x B x C	Peso/Weight
69078	220-240 V, 50/60 Hz	8	70 W	25 L	8 - 18°C	162 kWh/annum	25x49x54 cm	4,40 Kg
69071	220-240 V, 50/60 Hz	16	70 W	46 L	12 - 18°C	189 kWh/annum	44x48x51 cm	13,2 Kg
69072	220-240 V, 50/60 Hz	28	80 W	75 L	12 - 18°C	182 kWh/annum	48x53x73 cm	17,2 Kg

VINOTECA TERMOELÉCTRICA: el control y regulación de la temperatura, dependerá de la temperatura ambiental del establecimiento
THERMOELECTRIC WINE COOLER: Temperature control and regulation depend on the ambient temperature of the establishment



No introduzca alimentos o bebidas calientes
Do not introduce hot food or drinks

Professional use

Diseñado para refrigerar y mantener los alimentos y bebidas frescos
Designed to refrigerate and maintain fresh food and drinks

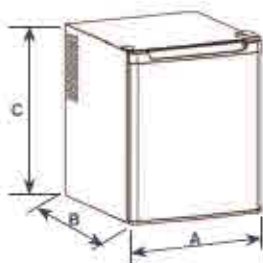

Refrigerador Mini-Bar

Mini frigo bar
Minibar Kühlschrank
Mini-Bar refrigerator
Refrigerador Mini-Bar

	Ref	€	W	U. Venta
A	69070	217,15	70	1
B	69075	217,15	70	1



Puerta reversible
Reversible door

Ref	Tensión/Voltage	Potencia/Power	Capacidad/Capac.	Temperatura/Temp.	Consumo/Cons.	Dimensiones/Size A x B x H	Peso/Weight
69070	220-240 V, 50/60 Hz	70 W	40 L	5°C - 12°C	197 kWh/annum	43x41x51 cm	9,0 Kg
69075	220-240 V, 50/60 Hz	70 W	40 L	5°C - 12°C	197 kWh/annum	43x41x51 cm	9,0 Kg

REFRIGERADOR TERMOELÉCTRICO: el control y regulación de la temperatura, dependerá de la temperatura ambiental del establecimiento
THERMOELECTRIC REFRIGERATOR: Temperature control and regulation depend on the ambient temperature of the establishment

▶ MÁQUINAS DE HIELO

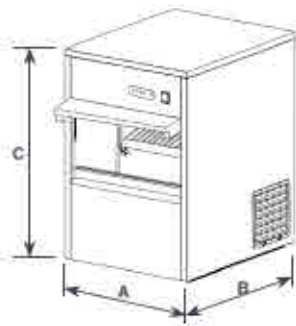

Perfecta para una producción de grandes volúmenes
Perfect for large volume production

Contenedor de 4 kg de capacidad
Container 4 kg capacity

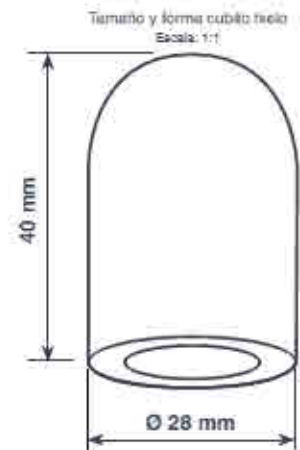

Professional use

Máquina de hielo

Machine à fabriquer des glaçons
Eiswürfelmaschine
Ice maker
Máquina de gelo

Ref	€	W	U.Venta
69320	920,47	170	1

Ref	Tensión/Voltage	Potencia/Power	Cap. contenedor hielo Ice container cap.	Producción/Product.	Cubo/Ice (Sizes)	Dimensiones/Sizes AxBxC	Peso/Weight
69320	220-240 V; 50/60 Hz	170 W	4 Kg	>20 Kg/24h	Ø28x40 mm	38x48x59 cm	27 Kg

Compacto, no ocupa mucho espacio
y puede trasladarse fácilmente
Compact, it does not take up much space
and can be easily moved

Dispone de programador
It has a programmer

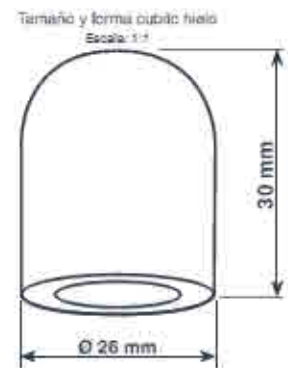

Aproximadamente en 10 ó 12 minutos, obtendrá cubitos de hielo.
ECO: Ahorro de energía y bajo nivel de ruido.

En 10 ou 12 minutes environ, vous obtenez des glaçons.
ECO: Économie d'énergie et faible bruit.

In ca. 10 bis 12 Minuten erhalten Sie Eiswürfel
ECO: Energiesparen und Rauschärmie.

In approximately 10 to 12 minutes you will have ice cubes.
ECO: Power save and low noise.

Cubos de gelo em aproximadamente 10 ou 12 minutos
ECO: Economia de energia e baixo nível de ruído



Household use

Máquina cubitos hielo

Machine à glaçons
Eiswürfelmaschine
Ice cubes maker
Máquina de fazer gelo

Ref	€	W	U.Venta
69314	355,55	150	1

Ref	Tensión/Voltage	Potencia/Power	Capacidad/Capacity	Contenedor/Cont.	Producción/Product.	Dimensiones/Sizes	Peso/Weight
69314	220-240 V; 50/60 Hz	150 W	1,50 L	600 g	10-15 Kg/24h	32x32x38 cm	11,30 Kg

PICADORAS DE HIELO

Semiprofessional use



Ideal para la preparación de cócteles, combinados, granizados, limonadas, refrescos, postres fríos, etc.

Una manera simple y rápida de obtener hielo picado en 30 segundos.

Cuerpo de acero inoxidable.

Anclajes de seguridad en el recipiente de recogida.

Todas las partes desmontables son aptas para lavavajillas.

4 patas con ventosas, aporta estabilidad a la hora de uso.

Ideal pour la préparation de cocktails, mélanges, granisés, limonades, rafraîchissements, desserts froids, etc.

Une façon simple et rapide d'obtenir de la glace pilée en 30 secondes.

Corps en acier inoxydable.

Ancrages de sécurité sur le récipient d'accueil.

Toutes les parties démontables sont aptes pour aller au lave-vaisselle.

4 pieds avec ventouses qui confèrent une stabilité lors de l'utilisation.

Ideal für die Zubereitung von Cocktails, Drinks, Sorbets, Limonaden, Erfrischungsgetränke, kalten Nachspeisen usw.

Eine einfache und schnelle Art, um innerhalb von 30 Sekunden durch

Gehäuse aus rostfreiem Stahl.

Sicherheitsverriegelungen am Auffangbehälter.

Alle abbaubaren Teile sind für den Geschirrspüler geeignet.

4 Füße mit Saugnapfen für erhöhte Stabilität im Betrieb.

Ideal for preparing cocktails, drinks, slushies, lemonade, soft drinks, cold desserts, etc.

A simple quick way to make crushed ice in 30 seconds.

Stainless steel body.

Safety anchors on the crushed ice container.

On/off switch.

All removable parts are dishwasher safe.

4 legs with suction cups, provides stability in operation.

Ideal para preparar cocktails, combinados, granizados, limonadas, refrescos, sobremesas frías, etc.

Uma maneira simples e rápida de obter gelo picado em 30 segundos.

Corpo de aço inoxidável.

Fixações de segurança no recipiente de recolha.

Todas as partes desmontáveis são aptas para máquinas de lavar louça.

4 patas com ventosas, para maior estabilidade durante a utilização.

Compacto, no ocupa mucho espacio y puede trasladarse fácilmente.
Compact, it does not take up much space and can be easily moved.



Picadora hielo
Broyeur à glaçons
Eis-Crusher
Ice crusher
Picadora de gelo

Cuchilla de acero inoxidable
Stainless steel blade

Compatible con las máquinas de hielo LACOR
Compatible with LACOR ice machines



Picadora de hielo PRO
Broyeur à glace
Eis-Crusher
Ice crusher
Picadora de gelo

Embudo de llenado extraíble
Removable cone

Ref	€	W	L	U.Venta
69310	73,87	100	0,50	1

Ref	€	W	L	Producción (Kg/h)	U.Venta
69313	95,04	80	2,80	12	1

Ref	Tensión/Voltage	Potencia/Power	Cap. hielo/Ice cap.	Capacidad/Capacity	Embudo/Funnel	Dimensiones/Sizes	Peso/Weight
69310	220-240 V, 50/60 Hz	100 W (5.500 r.p.m.)	-	0,50 L	-	18x20,5x46,5 cm	5,10 Kg
69313	220-240 V, 50/60 Hz	80 W	12 Kg/h	2,80 L	Ø14 cm	17x29x47,5 cm	11,30 Kg

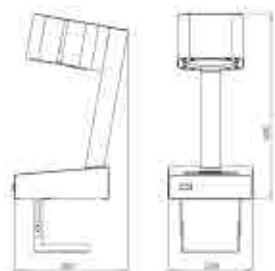

Gracias a su diseño, la FREEZE es perfecta para cualquier local ya que se adapta a todo tipo de superficies, ocupando el mínimo espacio.
Se puede ubicar donde se precise según las necesidades de cada ocasión.
Perfecta para negocios de mucha actividad.
Fabricado en acero inoxidable.
Conexión a botella de CO₂ de 28 ó 36 Kg.
Contador de operaciones.
Luces tipo LED de activación por impulsos de gas.
Sistema de conexión a botella con sistema de seguridad incluido.

Thanks to its design, the FREEZE is perfect for any local adapts to all types of surfaces, taking up a minimum of space.
Can be placed where required according to the needs of each occasion.
Perfect for busy business.
Made of steel stainless.
Connection to CO₂ bottle of 28 or 36 Kg.
Counter operations.
Lights activation type LED by impulses from gas.
Bottle with safety system including system.

Máquina enfriacopas FREEZE

Machine à grivrer les verres
Gläser-Kühlmaschine
Glass cooler machine
Máquina para enfriar copas

Precios NO sujetos al sistema de descuentos habitual de LACOR
Prix non soumis au système habituel de remises de LACOR
Prices not subject to the usual discount system of LACOR

Ref	€	W	U.Venta
69300	3.019,13	25	1

Ref	Tensión/Voltage	Potencia/Power	Programas/Program.	Dimensiones/Sizes	Peso/Weight
69300	220-240 V, 50/60 Hz	25 W	4	22,8x30,5x 50 cm	12 Kg

PRAXAIR



¿Qué tipo de gas utilizamos?

El gas que utilizan nuestras máquinas es Gas carbónico alimentario en estado líquido. El Dióxido de Carbono, también denominado óxido de carbono (IV), gas carbónico y anhídrido carbónico, CO₂, es insípido, incoloro, inodoro y no inflamable.
Aunque la forma más común en que se encuentra el CO₂ es en estado gaseoso, bajo determinadas condiciones se puede encontrar también en estado líquido o sólido. Estas botellas están destinadas para uso médico y alimentario y lo que las diferencia del resto es que en su interior cuenta con una sonda que extrae el líquido criogénico que al liberarse alcanza una temperatura de -79,8 °C

Seguridad LACOR

- 1.- Funcionamiento a base de gas carbónico líquido alimentario
- 2.- Control de presión de gas. Control de temperatura de congelación del gas ajustable de -8 a -55°C
- 3.- Fabricado en Acero Inoxidable de uso médico y alimentario. Todos los conductos interiores están fabricados en AISI-316 garantizando las óptimas condiciones alimentarias e higiénico-sanitarias
- 4.- Adaptable a cualquier tamaño de copa o vaso
- 5.- Exclusivo sistema de seguridad patentado y control para presiones superiores a 100 bar

Nuestros artículos cumplen las siguientes normativas:

- 1.- Directiva 2006/95/CE de seguridad eléctrica
- 2.- Directiva 2006/108/CE de compatibilidad electromagnética
- 3.- Directiva 2006/42/CE de máquinas
- 4.- Norma UNE-EN ISO 12100-1:2004
- 5.- Norma UNE-EN ISO 12100-2:2004
- 6.- Norma EN 614-1:1996
- 7.- Norma UNE-EN ISO 13850:2007
- 8.- Norma UNE-EN 60335-1

What type of gas do we use?

Our machines use liquid food grade Carbon dioxide gas, Carbon Dioxide, also called carbon oxide (IV), carbonic gas and carbon anhydride, CO₂, is insipid, colourless, odourless and not flammable.
Although the most common state of CO₂ is gaseous, under certain conditions it can also be found in liquid or solid state. These bottles are used for medical and food uses and they are different from the rest in that their interiors have a probe that extracts the cryogenic liquid which when freed reaches temperatures of -79.8 °C

LACOR Safety

- 1.- Operability based on liquid food grade carbon dioxide gas.
- 2.- Control of gas pressure. Control of freezing temperature of the gas adjustable from -8 to -55 °C
- 3.- Manufactured from Stainless Steel for medical and food use. All the internal conductors are manufactured from AISI-316 guaranteeing optimal food and hygiene-health condition.
- 4.- Adaptable to any size of glasses
- 5.- Exclusive patented safety system and control for pressures above 100 bar

Our articles fulfil the following standards:

- 1.- Directive 2006/95/CE for electrical safety
- 2.- Directive 2004/108/EC for electromagnetic compatibility
- 3.- Directive 2006/42/CE for machinery
- 4.- UNE-EN ISO 12100-1:2004 Standard
- 5.- UNE-EN ISO 12100-2:2004 Standard
- 6.- EN 614-1:1996 Standard
- 7.- UNE-EN ISO 13850:2007 Standard
- 8.- UNE-EN 60335-1 Standard





Sistema de gran impacto visual. Crea tus propios diseños. Muy fácil de usar, dibuja o escribe encima con los rotuladores fluorescentes especiales, pero NUNCA con la pizarra encendida. Se borra con un trapo. Se pueden colocar tanto vertical como horizontalmente. Consume muy poco.

Systeme d'un grand impact visuel. Concevez vos propres créations. Très facile à utiliser, dessinez ou écrivez dessus avec les feutres fluorescents spéciaux mais JAMAIS lorsque le tableau est allumé. S'efface avec un chiffon. Peut être installé aussi bien à la verticale qu'à l'horizontale. Consomme très peu.

System mit Blickfang-Effekt. Schaff' Dein eigenes Design. Ganz einfach im Gebrauch, schreib oder zeichne mit den fluoreszierenden Spezialstiften, aber NIE wenn die Tafel eingeschaltet ist. Mit Lappen auswischen. Lässt sich sowohl waagrecht als auch senkrecht aufhängen. Gering im Verbrauch.

Very eye-catching system. Create your own designs. Very easy to use, draw or write on it with the special fluorescent markers, but NEVER when the blackboard is on. Wipes clean with a cloth. Can be placed both vertically and horizontally. Consumes very little power.

Sistema de grande impacto visual, para criar os seus próprios desenhos. Muito fácil de utilizar, permite desenhar ou escrever em cima com os rotuladores fluorescentes especiais. NUNCA escreva no quadro com este ligado. A escrita apaga-se com um trapo. Podem colocar-se vertical ou horizontalmente. Baixo consumo.

8 colores para usar con la pizarra eléctrica Led
8 colors to use with the Led electric board



**No tóxicos
fácil de limpiar**
Non toxic, easy to clean

Rotuladores fluorescentes 8 colores

Marqueurs fluorescents 8 couleurs
8-Farben fluoreszierenden marker
Fluorescent markers 8 colors
Maracadores fluorescentes 8 cores

Ref	€	cm	U.Venta
39161	28,01	10	1

Limpieza muy sencilla
Cleaning very simple

Crea tus propios diseños
Create your own designs

**Sistema llamativo
Gran impacto visual**
Eye-catching system
Great visual impact



**NO Incluidos
NOT Included**

Pizarra LED
Tableau lumineux à LED
LED Tafel
Blackboard LED
Ardósia LED

Ref	€	W	U.Venta
A 39140	85,74	2	1
B 39160	119,11	2	1

Ref	Tensión/Voltage	Potencia/Power	Funcioned/Functions	Dimensiones/Sizes	Peso/Weight
39140	220-240 V; 50/60 Hz	2 W	38	40x60 cm	2,35 Kg
39160	220-240 V; 50/60 Hz	2 W	38	60x80 cm	4,50 Kg



Cabezal orientable y abatible
Rotatable, swiveling head

Plataforma inoxidable 53x44cm (21"x17")
Batería interna recargable (Autonomía 15 días)
Cuerpo aluminio fundido
Patas de apoyo regulables
Visor de nivel, planitud
Avisador acústico de sobrecarga
Teclado intuitivo y de fácil uso
Funciones de calculadora
Acumulación de importes
Unidades de medida (Kgs., Oz., Libras)
Función de tara
Libro de instrucciones en 7 idiomas

Plataforma inoxidable 53x44 cm
 Batería interna recargable (Autonomía 15 días)
 Corp en aluminium moulé
 Pieds réglables
 Indicateur de niveau, de planité
 Avertisseur acoustique de surcharge
 Clavier intuitif d'utilisation facile
 Fonctions de calculatrice
 Accumulation de sommes
 Unités de mesure (Kgs., Oz., Livres)
 Fonction de tare
 Mode d'emploi en 7 langues

Rostra Acrylgefäße 53x44 cm
 Integrierte aufladbare Batterie (Leistungsdauer 15 Tage)
 Gestärkter aus Aluminiumguss
 Regulierbare Stützfüße
 Nivellierung-, Planheitsanzeige
 Akustischer Warnton bei Überlastung
 Berührungsempfindliche, einfach anzuwendende Tastatur
 Rechenfunktionen
 Kumulierung mehrerer Beträge
 Gewichtseinheiten (Kgs., Oz., Pfund)
 Tara-Funktion
 Handbuch in 7 Sprachen

St. Steel platform, 53x44 cm
 Rechargeable internal battery (Last: 15 days)
 Cast aluminium case
 Adjustable support feet
 Level and flatness indicator
 Overload alarm
 Intelligent and easy-to-use keyboard
 Calculator functions
 Total counter
 Measurement units (Kgs., Oz., pounds)
 Tare function
 Instructions book in 7 languages

Plataforma inoxidável 53x44 cm
 Bateria interna recarregável (Autonomia 15 dias)
 Corpo alumínio fundido
 Patas de apoio reguláveis
 Visor de nível, planitude
 Avisador acústico de sobrecarga
 Teclado intuitivo e de fácil uso
 Função de calculadora
 acumulação de somas
 Unidades de medida (Kgs., Oz., pounds)
 Função de tara
 Livro de instruções em 7 idiomas

Báscula electrónica con base cuadrada 150 Kg (20 g)

Balance professionnel électronique 150 Kgs. (20g)
 Elektronische Küchenwaage mit rechteckigem Oberteil 150 Kg (20g)
 Electronic bench scale w/square base 150 Kg (20g)
 Balança electrónica com base quadrada 150 Kg (20 g)

Ref	€	U.Venta
61700	986,46	1

Ref	Tensión/Voltage	Tara/Tare	Dimensiones/Sizes	Peso/Weight
61700	220-240 V / 50-60 Hz	150 Kg (20 g)	49x75x60 cm	45 Kg

CERTIF.: 89/336/ECC, 91/263/EEC, 92/31/ECC, 93/68/EEC en 50 082 - 1:1992



Plataforma inoxidable 30x24 cm (12"x9 1/2")
Cable conexión 230V 50 Hz
Batería interna recargable (Autonomía 15 días)
Doble display
Plataforma extraíble, fácil limpieza
Patas de apoyo regulables
Visor de nivel, planitud
Avisador acústico de sobrecarga
Teclado intuitivo y de fácil uso
Funciones cambio
Seis memorias programables
Unidades de medida (Kgs., Oz., Libras)
Función de tara
Libro de instrucciones en 7 idiomas

Plataforma inoxidable 30x24 cms. (12"x9 1/2")
 Cable conexión 230 V 50 Hz
 Batería interna recargable (Autonomía 15 días)
 Double display
 Plataforma extraíble, limpieza fácil
 Pieds réglables
 Indicateur de niveau, de planité
 Avertisseur acoustique de surcharge
 Clavier intuitif d'utilisation facile
 Fonctions changement
 Six mémoires programmable
 Unités de mesure (Kgs., Oz., Livres)
 Fonction de tare
 Mode d'emploi en 7 langues

Rostra Acrylgefäße 30x24 cms. (12"x9 1/2")
 Anschlußkabel 230 V 50 Hz
 Integrierte aufladbare Batterie (Leistungsdauer 15 Tage)
 Doppelles Display
 Abnehmbare Stützfläche einfache Reinigung
 Regulierbare Stützfüße
 Nivellierung-, Planheitsanzeige
 Akustischer Warnton bei Überlastung
 Berührungsempfindliche, einfach anzuwendende Tastatur
 Rechenfunktionen
 Sechs programmierbare Speicher
 Gewichtseinheiten (Kgs., Oz., Pfund)
 Tara-Funktion
 Handbuch in 7 Sprachen

St. Steel platform, 30x24 cms. (12"x9 1/2")
 230 V 50 Hz connection cable
 Rechargeable internal battery (Last: 15 days)
 Double display
 Removable, easy-to-clean platform
 Adjustable support feet
 Level and flatness indicator
 Overload alarm
 Intelligent and easy-to-use keyboard
 Change functions
 Six programmable memories
 Measurement units (Kgs., Oz., pounds)
 Tare function
 Instructions book in 7 languages

Plataforma inoxidável 30x24 cms. (12"x9 1/2")
 230 V 50 Hz cabo de ligação
 Bateria interna recarregável (Autonomia 15 dias)
 Duplo avanço
 Plataforma extraível, fácil limpeza
 Patas de apoio reguláveis
 Visor de nível, planitude
 Avisador acústico de sobrecarga
 Teclado intuitivo e de fácil uso
 Função de mudança
 Seis memórias programáveis
 Unidades de medida (Kgs., Oz., pounds)
 Função de tara
 Livro de instruções em 7 idiomas

Báscula electrónica con base cuadrada

Balance de cuisine électronique
 Elektronische Küchenwaage mit rechteckigem Oberteil
 Electronic scale w/square base
 Balança electrónica com base quadrada

Ref	€	Tara
61716	406,18	15kg/5g
61730	437,10	30kg/10g

Ref	Tensión/Voltage	Potencia/Power	Tara/Tare	IP	Dimensiones/Sizes	Peso/Weight
61716	220-240 V / 50-60 Hz	0,2 W (max)	15 Kgr (5 g)	IPX 54	30x32x12 cm	4,60 Kg
61730	220-240 V / 50-60 Hz	0,2 W (max)	30 Kgr (10 g)	IPX 54	30x32x12 cm	4,60 Kg

▶ AFILADORES

Household use | CE | AC



Afilador de cuchillos
Affûteuse de couteaux
Schärfmaschine
Knife sharpener
Afilador de facas

Ref	€	W	U.Venta
69141	27,29	60	1

Cuchillos
lisos y dentados
Smooth and serrated knives



Afilador de cuchillos
Affûteuse de couteaux
Schärfmaschine
Knife sharpener
Afilador de facas

Ref	€	W	U.Venta
69261	106,86	80	1



Phase 1: Alta abrasividad - High abrasiveness
Phase 2: Afilado fino - Thin sharp
Phase 3: Micro-afilado - Micro-sharp



Afilador de cuchillos
Affûteuse de couteaux
Schärfmaschine
Knife sharpener
Afilador de facas

Ref	€	W	U.Venta
60359	42,23	60	1

Ref	Tensión/Voltage	Potencia/Power	Dimensiones/Sizes	Peso/Weight
69141	220-240 V; 50 Hz	60 W	13,5x15x9 cm	0,84 Kg
69261	220-240 V; 50/60 Hz	80 W	32x11,5x10 cm	2,20 Kg
60359	220-240 V; 50/60 Hz	60 W	16x11x7,5 cm	0,56 Kg

▶ ESTERILIZADORES

Professional use | Inox | CE

Esterilización mediante rayos ultravioletas germicidas que transforman el oxígeno en ozono, destruyendo bacterias, hongos y virus

Sterilisation by ultraviolet germicidal rays that transform oxygen into ozone, destroying bacteria, fungi and viruses

IP21



Armario esterilizador cuchillos ultravioleta

Armoire à stériliser
Sterilisierungsschank
Knife sterilization
Armário esterilizador facas

Ref	€	W	U.Venta
A 39012	564,40	15	1
B 39124	756,55	15	1

A 10 cuchillos - 10 Knives
B 20 cuchillos - 20 Knives



Ref	Cuchillos/Knives	Tensión/Voltage	Potencia/Power	Reloj/Timer	Dimensiones/Sizes	Peso/Weight
39012	10	230 V; 50/60 Hz	15 W	120 min	36x13x57 cm	4,785 Kg
39124	20	230 V; 50/60 Hz	15 W	120 min	45x13x57 cm	5,630 Kg

▶ MATA MOSQUITOS

Professional use



Perfecto para el uso en lugares públicos como bares, restaurantes, hoteles, etc. Su elegante diseño es ideal para darle un toque moderno a cualquier espacio. Discreto, silencioso y seguro, sin descarga eléctrica. Es una alternativa perfecta a los insecticidas y mata-moscas tradicionales. No contamina (sin químicos ni venenos), evita la fragmentación del insecto y la dispersión de las bacterias. La luz ultravioleta atrae todo tipo de insectos voladores los cuales se eliminan mediante el papel adhesivo. El papel adhesivo se sustituye en segundos, ofreciendo una limpieza fácil y rápida.

Parfait pour une utilisation dans des lieux publics tels que des bars, restaurants, hôtels, etc. Son style est idéal pour apporter une touche moderne à tout type d'espace. Discret, silencieux et sûr, sans décharge électrique. Il s'agit d'une excellente alternative aux insecticides et tue-mouches traditionnels. Ne pollue (pas de produits chimiques ou de poisons); évite la fragmentation de l'insecte et la dispersion des bactéries. La lumière ultraviolette attire tout type d'insectes volants, qui sont éliminés à travers le papier adhésif. Le remplacement du papier adhésif s'effectue en quelques secondes, permettant ainsi un nettoyage facile et rapide.

Ideal zum Einsatz in öffentlichen Bereichen wie Gaststätten, Restaurants, Hotels, usw. Sein elegantes Design verleiht ihm ein modernes Aussehen in allen Räumen. Diskret, leise und sicher, ohne elektrische Entladungen. Eine perfekte Alternative zu herkömmlichen Insekt- und Fliegenbekämpfungsmitteln. Es erfolgt keine Kontamination (keine Chemikalien oder Gifte), Insekt nicht fragmentiert und die Bakterien nicht verbreitet werden. Das UV-Licht zieht alle möglichen fliegenden Insekten an, die mithilfe des Klebapiers eliminiert werden. Der Austausch des Klebapiers erfolgt sekundenschnell für eine einfache und schnelle Reinigung.

Perfect for public places like bars, restaurants, hotels, etc. It's elegant design is perfect for giving a modern touch to any space. It's discreet, quiet and safe and doesn't produce electric shocks. It's a perfect alternative to insecticides and traditional. Doesn't pollute (no chemicals or poisons), it doesn't crush insects and spread bacteria. The UV light attracts all kinds of flying insects which get eliminated using adhesive paper. The adhesive paper can be changed in seconds for fast and easy cleaning.

Perfeito para uso em lugares públicos, como bares, restaurantes, hotéis, etc. O seu design elegante é ideal para dar um toque moderno a qualquer espaço. Discreto, silencioso e seguro, sem descargas elétricas. Uma alternativa perfeita aos inseticidas e mata-moscas tradicionais. Não contamina (sem produtos químicos ou venenos), evitando a fragmentação dos insetos e a dispersão das bactérias. A luz ultravioleta atrai todo o tipo de insetos voadores, que são eliminados pelo papel adesivo. O papel adesivo substitui-se em segundos, proporcionando uma limpeza fácil e rápida.

Sin descargas eléctricas
Doesn't produce electric shocks



ABS
Plastic

Matamosquitos DECOR

Anti-moustiques
Fliegenfänger
Mosquito killer
Mata mosquito



Set de 3 láminas adhesivas

Ensemble de 3 feuilles adhesives
Set von 3 Kleebe Folie
Set of 3 adhesive sheet
Conjunto de 3 folhas adesivas



Ref	€	U.Venta
R39135C	11,36	1

* Se recomienda reemplazar el papel adhesivo cada 10 días pero si más de 2/3 del papel está cubierto de moscas, reemplázalo el papel.
It is recommended that you replace the sticky/fly paper every 10 days but if more than 2/3 of the paper is covered in flies, replace the paper.

Ref	€	W	Área Protección	U.Venta
39135	87,36	35	60 m ²	1

Ref	Tensión/Voltage	Potencia/Power	Área protec./Prot. area	Lámparas/Lamps	L. cable /Cord length	Dimensiones/Sizes	Peso/Weight
39135	220-240 V; 50/60 Hz	35 W	60 m ²	2 x 15W	115 cm	42x23,8x17,3 cm	1,36 Kg

New

Vida útil de trabajo: 10.000 h
Useful working life: 10.000 h



PP

Polypropylene

Matamosquitos WHITE

Anti-moustiques
Mückentalle
Mosquito killer
Mata-mosquitos

Ref	€	W	Área protección	U.Venta
39129	55,82	3,5	50 m ²	1

Uso interior: hogar, oficinas, hoteles, locales comerciales, restaurantes, etc.
Dispone de 2 lámparas LED de alta calidad y con una longitud de onda óptima para atraer a todo tipo de insectos voladores.
Una alternativa perfecta a los insecticidas, libre de contaminación e inocuo para los humanos.
Rejilla metálica de 2500V en el interior donde los insectos son electrocutados.

Utilisation en intérieur : logements, bureaux, hôtels, boutiques, restaurants, etc.
Dispose de 2 ampoules LED de grande qualité et d'une longueur d'ondes optimale pour attirer tout type d'insectes volants.
Une alternative parfaite aux insecticides, sans contamination et inoffensive pour les humains.
Dispose d'une grille métallique de 2500V à l'intérieur, où les insectes sont électrocutés.

Für Haushalt, Büro, Läden, Restaurants und weitere Innenbereiche
Wellenlänge der beiden hochwertigen LED-Leuchten zieht alle möglichen Fluginsekten an
Insektenbekämpfungsmittel ohne Schadstoffe und für Menschen harmlos
Eingebaute 2.500 V Gitterplatte tötet Insekten durch Stromschlag

Designed for indoor use: Home, offices, hotels, businesses, restaurants, etc.
It has 2 high quality LED lights with an optimal wavelength for attracting all kinds of flying insects
It's a perfect alternative to insecticide because it's pollution free and innocuous to humans
It has a 2500 V metal screen inside where insects are electrocuted

Uso interior en viviendas, escritorios, hoteles, establecimientos comerciales, restaurantes, etc.
Dispone de 2 lámparas LED de alta calidad, con un comprimento de onda optimizado para atraer todo o tipo de insectos voladores.
Uma alternativa perfeita aos insecticidas, não contaminante e inocua para as pessoas.
Equipada com uma grelha metálica de 2500 V no interior, que electrocuta os insetos.



2 lámparas LED
2 LED lights



Bandeja extraíble
Removable tray



Incluye cuerda para colgar
Includes a cord for hanging

Ref	Tensión/Voltage	Potencia/Power	Longitud onda/Wavelength	Descarga eléct./Electric shock	Área protección/Protection area	Vida útil/Useful life	Cable Cord	Dimensiones/Sizes	Peso/Weight
39129	220-240 V / 50/60 Hz	3,5 W	398 nm	2500 V	50 m ²	10.000 h	1,50 m	Ø36,6x8,3 cm	1,40 Kg

A



Luz ultravioleta
Ultraviolet light

B



La luz ultravioleta atrae a los mosquitos y gracias a una pequeña descarga eléctrica, son fulminados en el acto.
Funciona mediante corriente eléctrica, libre de productos tóxicos.
Bandeja extraíble para una fácil limpieza.
Diseñado para uso interior: hogar, oficinas, hoteles, locales comerciales, restaurantes, fábricas, etc.

La lumière ultraviolette attire les moustiques qui sont immédiatement éliminés grâce à une petite décharge électrique.
Fonctionnement par courant électrique, sans produits toxiques.
Plateau amovible pour un nettoyage facile.
Conçu pour un usage intérieur : foyers, bureaux, hôtels, établissements commerciaux, restaurants, usines, etc.

Das ultraviolette Licht zieht Mücken an und diese werden anhand einer kleinen elektrischen Entladung sofort vernichtet.
Betrieb mit elektrischem Strom, frei von giftigen Bestandteilen.
Herausziehbares Blech für einfache Reinigung.
Für Verwendung in geschlossenen Räumen konzipiert: Haushalt, Büros, Hotels, Läden, Restaurants, Fabriken, etc.

The ultraviolet light attracts mosquitoes and, thanks to a small electric shock, they are killed instantly.
Powered by electric current, free from toxic products.
Removable tray for easy cleaning.
Designed for indoor use: home, offices, hotels, business premises, restaurants, factories, etc.

A luz ultravioleta atrai os mosquitos, que são fulminados instantaneamente por uma pequena descarga elétrica.
Funciona com corrente elétrica, sem produtos tóxicos.
Bandeja extraível para facilitar a limpeza.
Concebido para uso interior: em casa, no escritório, hotéis, estabelecimentos comerciais, restaurantes, fábricas, etc.

ABS AL

Plastic Aluminium

Matamosquitos

Appareil anti-moustiques
Fliegenfänger
Mosquito killer
Mata mosquitos

Ref	€	W	Área Protección	U.Venta
A 39128	79,27	22	60 - 80 m ²	1
B 39137	97,53	33	100 - 1200 m ²	1

Ref	Tensión/Voltage	Potencia/Power	Lámparas/Lamps	Área protec./Prot. area	Dimensiones/Sizes	Peso/Weight
39128	220-240 V / 50-60 Hz	22 W	2 x 10W	60 - 80 m ²	33,8x9,9x26 cm	2,20 Kg
39137	220-240 V / 50-60 Hz	33 W	3 x 10W	100 - 1200 m ²	50,3x10x26 cm	2,83 Kg



Vida útil de trabajo
Funcional lifespan
20.000 h

ABS

Plastic

Matamosquitos LUCE

Anti-moustiques
Fliegenfänger
Moskito killer
Mata mosquitos



Ref	€	W	Área Protección	U.Venta
A 39126	76,98	11	150 m ²	1
B 39127	94,21	13	300 m ²	1

Ref	Tensión/Voltage	Potencia/Power	Bombillas/Bulbs	Área protec./Prot. area	L. cable./Cord length	Dimensiones/Sizes	Peso/Weight
39126	220-240 V, 50/60 Hz	11 W	16 UV-A LED	150 m ²	1,10 m	33x10x36,3 cm	1,50 Kg
39127	220-240 V, 50/60 Hz	13 W	20 UV-A LED	300 m ²	1,10 m	47x10x36,3 cm	3,00 Kg

Diseñado para lugares públicos como bares, restaurantes, hoteles, etc. Una alternativa perfecta a los insecticidas, libre de contaminación e inocuo para los humanos.

Dispone de rejilla metálica de alto voltaje (4000V) en el interior donde los insectos son electrocutados con una tasa de eliminación instantánea del 100%. Bandeja desmontable recoge insectos en la parte inferior, facilita la limpieza.

Conçu pour des lieux publics tels que les bars, les restaurants, les hôtels, etc. Une alternative parfaite aux insecticides, sans contamination et inoffensif pour les humains. Dispose d'une grille métallique de haut voltage (4000V) à l'intérieur où les insectes sont électrocutés avec un taux d'élimination instantanée de 100%. Plateau démontable ramasse-insectes dans la partie inférieure, qui facilite le nettoyage.

Konzipiert für öffentliche Bereiche wie Kneipen, Restaurants, Hotels usw. Eine perfekte Alternative zu Insektenbekämpfungsmitteln, schadstofffrei und ungiftig für Menschen. Im Inneren befindet sich ein unter Hochspannung stehendes Metallgitter (4000 V), an dem die Insekten per Stromschlag sofort und zu 100 % getötet werden. Demontierbare Insekten-Aufnahmwanne im Inneren, um die Reinigung zu erleichtern.

Designed for public spaces such as bars, restaurants, hotels, etc. A perfect alternative to insecticides, free from contamination and harmless to humans. It has an internal high-voltage metal grill (4000V) that instantaneously electrocutes insects with a 100% elimination rate. Removable tray that collects insects on the bottom, facilitating cleaning.

Desenhado para lugares públicos, como bares, restaurantes, hotéis, etc. Uma alternativa perfeita aos inseticidas, não contaminante e inócua para os seres humanos. Com rede metálica de alta voltagem (4000 V) no interior, que electrocuta instantaneamente 100% dos insetos. Bandeja recolhadora de insetos desmontável localizada na parte inferior, que facilita a limpeza do aparelho.



Luz ultravioleta
Ultraviolet light



Luz ultravioleta
Ultraviolet light



ABS

Plastic

Matamosquitos negro

Appareil anti-moustiques noir
Fliegenfänger, schwarz
Moskito killer black
Mata mosquitos preto

Ref	€	W	Área Protección	U.Venta
A 39138	17,74	4	40 m ²	1
B 39139	20,13	6	60 m ²	1

ABS

Plastic

Mata mosquitos

Appareil anti-moustiques
Fliegenfänger
Moskito killer
Mata mosquitos

Ref	€	W	Área Protección	U.Venta
39133	30,40	12	50 m ²	1

Ref	Tensión/Voltage	Potencia/Power	Área protec./Prot. area	Dimensiones/Sizes	Peso/Weight
39138	220-240 V, 50/60 Hz	4 W	40 m ²	Ø12x25 cm	350 g
39139	220-240 V, 50/60 Hz	6 W	60 m ²	Ø12x33 cm	875 g
39133	220-240 V, 50/60 Hz	13 W	50 m ²	Ø27x27 cm	950 g



Ideal para bares y restaurantes con mesas en el exterior.
Funciona mediante lámparas de calentamiento halógeno infrarrojos.
Malla protectora para evitar quemaduras.
Resistente al polvo y agua (IP).

Idéal pour les bars et les restaurants ayant des tables à l'extérieur.
Fonctionne à l'aide de lampes de réchauffement halogènes par infrarouges.
Maillage de protection pour éviter les brûlures.
Résistant à la poussière et à l'eau (IP).

Ideal für Bars und Restaurants mit Tischen im Freien.
Arbeitet mit infraroten Halogenheizlampen.
Gitter schützt vor Verbrühungen.
Staub- und Wasserabweisend.

Ideal for bars and restaurants with tables outside.
Powered by infrared halogen heating lamps.
Protective mesh to prevent burns.
Dust and water resistant (IP).

Ideal para bares e restaurantes com mesas no exterior.
Funciona com lâmpadas de aquecimento de halogéneo por infravermelhos.
Malha de proteção para evitar queimaduras.
Resistente ao pó e à água (IP).

¿Qué es la clasificación IP? · What is the IP classification?

IP 54

1º dígito; protección contra objetos y polvo 1st digit; protection against objects and dust	2º dígito; protección contra líquidos 1st digit; protection against liquids
<p>IP0: Sin protección · Without protection</p> <p>IP1: Protección contra objetos con un Ø mayor de 50 mm Protection against objects with Ø greater than 50 mm</p> <p>IP2: Protección contra objetos con un Ø mayor a 12 mm Protection against objects with Ø greater than 12 mm</p> <p>IP3: Protección contra objetos con un Ø mayor a 2,5 mm Protection against objects with Ø greater than 2,5 mm</p> <p>IP4: Protección contra objetos con un Ø mayor a 1 mm Protection against objects with Ø greater than 1 mm</p> <p>IP5: Protección contra polvo · Protection against dust</p> <p>IP6: A prueba de polvo · Testing against dust</p>	<p>IPX0: Sin protección · Without protection</p> <p>IPX1: Protección contra gotas de agua Protection against water drops</p> <p>IPX2: Protección contra el goteo de agua con una inclinación de 15° · Protection against dripping water with an inclination of 15°</p> <p>IPX3: Protección contra pulverización Protection against spray</p> <p>IPX4: Protección contra salpicaduras · Splash protection</p> <p>IPX5: Protección contra chorros de agua Protection against water jets</p> <p>IPX6: Protección contra aguaceros Protection against downpours</p> <p>IPX7: Protección contra la inmersión durante un tiempo determinado · Protection against immersion for a certain time</p> <p>IPX8: Protección contra permanencia bajo agua Protection against permanence under water</p>

CALENTADORES PIE

New



Desmontable en 3 partes, lo cual facilita el almacenaje de larga duración.
El cabezal del calentador tiene un radio de giro de 40°.
Base redonda y pesada para una mejor estabilidad y seguridad.
Seguro y respetuoso con el medio ambiente, no produce ni ruidos ni olores.
Incluye unos accesorios para el anclaje del calefactor.

Démontable en 3 parties, ce qui facilite le rangement de longue durée.
La tête du chauffage a un rayon de rotation de 40°.
Base ronde et lourde pour une meilleure stabilité et sécurité.
Sûr et respectueux de l'environnement, ne produit ni bruit ni odeurs.
Inclut des accessoires pour l'ancrage du chauffage.

Can be disassembled into 3 parts for easy long term storage.
The head of the heater has a 40° rotation radius.
Heavy round base for better stability and safety.
Safe and environmentally friendly. Does not produce noise or odours.
Includes accessories for anchoring the heater.

Área de calentamiento Heating area

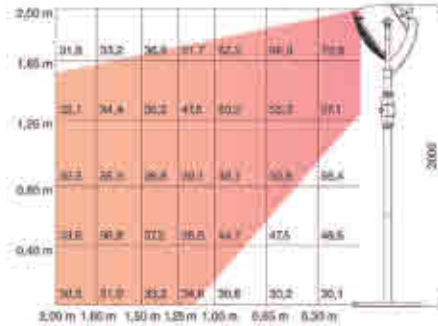

Ref	€	W	U.Venta
69414	388,03	2100	1

Ref	Tensión/Voltage	Potencia/Power	Lámparas/Lamps	N. calentamiento/Heating levels	Ángulo de giro/Angle of rotation	Nivel protección/Protection level	Dimensiones/Sizes	Peso/Weight
69414	220-240 V ; 50/60 Hz	2100 W	2	3 (900/1200/2100W)	40°	IP54	45x45x210 cm	17,0 Kg

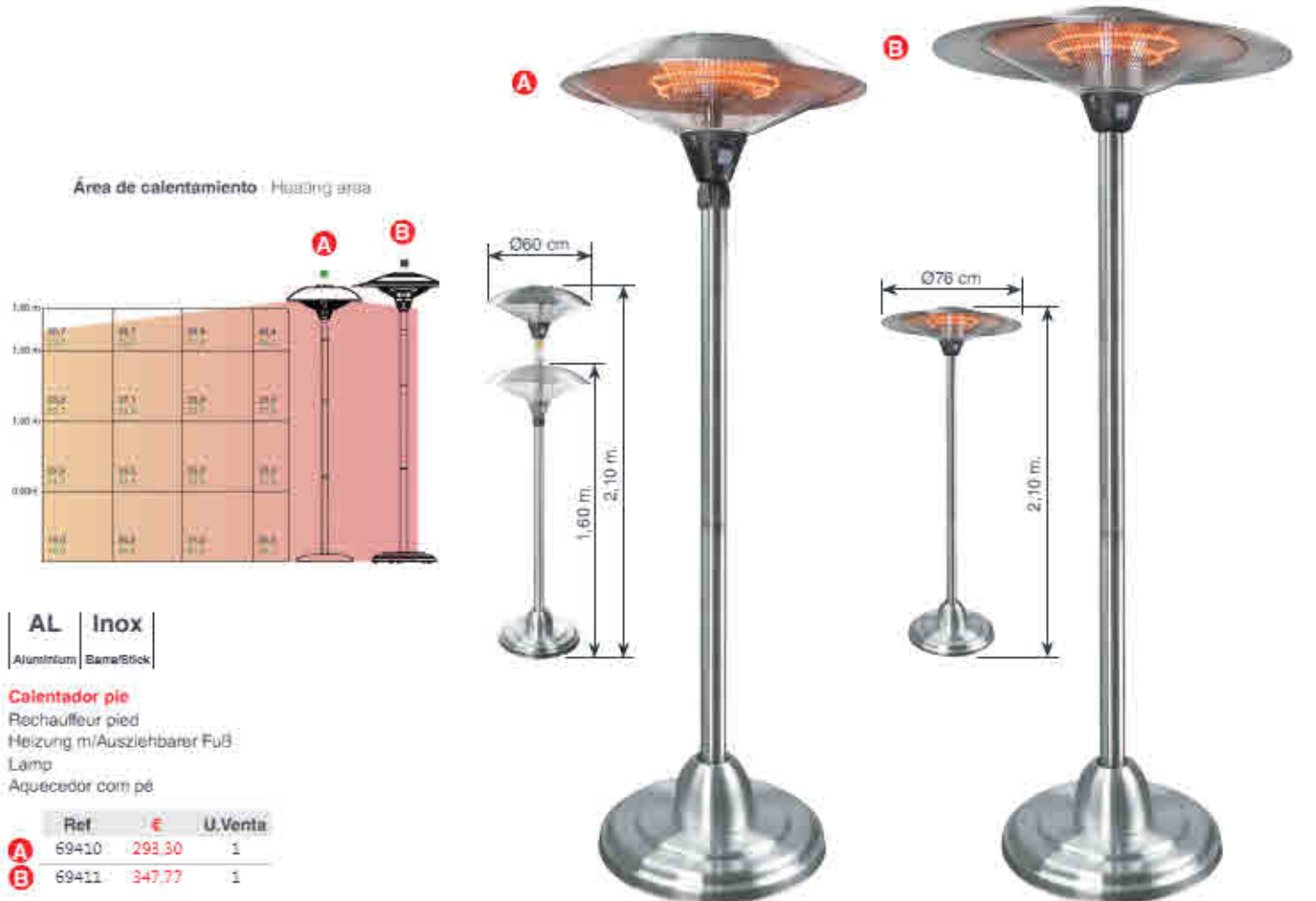

Área de calentamiento Heating area



AL | Inox
Aluminium | BamaStick

Calentador pie
Rechauffeur pied
Heizung m/Ausziehbarer Fuß
Lamp
Aquecedor com pé

Ref	€	U.Venta
A 69410	293,30	1
B 69411	347,77	1

Ref	Tensión/Voltage	Potencia/Power	IP	Altura/Height	Cable/Cord	Calent./Heating	Dimensiones/Sizes	Peso/Weight
69410	220-240 V; 50/60 Hz	900/1200/2100 W	IP44	2,10 m	3,5 m	Lámp. calentamiento Halógeno infrarrojos Halogen infrared heating lamp	Ø58,5x1,6 - 2,05 m	13,35 Kg
69411	220-240 V; 50/60 Hz	1200/1800/3000 W	IP44	2,10 m	3,5 m		Ø76x2,10 m	14,40 Kg

LÁMPARAS CALENTADORAS

New

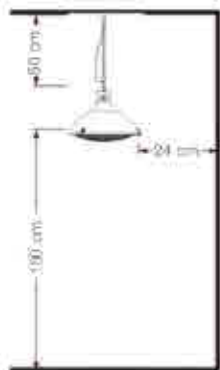

Rejilla protectora
Protective grill

AL

Aluminium

Lámpara calentadora eléctrica de techo

Parasol chauffant électrique suspendu
Elektrischer Deckenheizstrahler
Electric hanging lamp heater
Candeeiro aquecedor elétrico de tecto

Ref	€	W	U.Venta
69422	178,87	1200	1

Fácil de montar, incluye una cadena de 1 m de longitud para instalarla en el techo.

Cuenta con un control remoto para encender y apagar la lámpara calentadora. Calor instantáneo, tiene 3 niveles de calentamiento (900 / 1200 / 2100 W). Seguro y respetuoso con el medio ambiente, no produce ni ruidos ni olores.

Facile à monter, il inclut une chaîne de 1 m de longueur pour l'installer au plafond. Dispose d'une télécommande pour allumer et éteindre le chauffage. Chaleur instantanée, dispose de 3 niveaux de chauffe (900 / 1200 / 2100 W). Sûr et respectueux de l'environnement, ne produit ni bruit ni odeurs.

Easy to assemble. Includes a 1m chain for ceiling installation. The lamp heater has a remote control to turn it on and off. Instant heat. It has 3 heating levels (900 / 1200 / 2100 W). Safe and environmentally friendly. Does not produce noise or odours.

Para instalar el calentador tenga en cuenta las distancias mínimas de seguridad que aparecen en la imagen

Be aware of the minimum safety distances shown in the image when installing the heater

Área de calentamiento - Heating area



Ref	Tensión/Voltage	Potencia/Power	Lámparas Lamps	N. calentamiento Heating levels	Long. cadena Chain length	Nivel protección Protection level	Dimensiones Sizes	Peso/Weight
69422	220-240 V, 50/60 Hz	2100 W	2	3 (900/1200/2100W)	1,0 m	IP44	43x43x36 cm	3,15 Kg



Max: Ø6 cm
Min: Ø2,5 cm

Área de calentamiento - Heating area

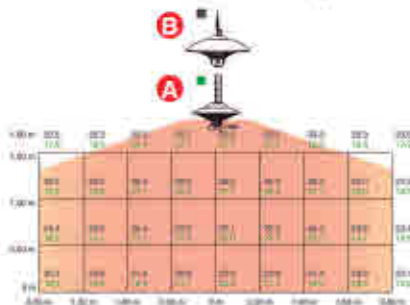

Área de calentamiento - Heating area

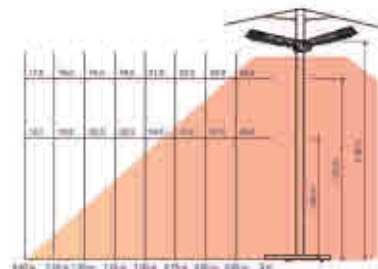

AL

Aluminium

Lámpara calentador

Lampe chauffe
Heizelement, freihängend
Lamp
Lâmpada aquecedora

Ref	€	W	U.Venta
69420	150,02	1500	1
69421	202,11	900/1200/1500	1

A
B

AL

Fe

Aluminium

Iron

Calentador brazos abatibles

Lampe chauffege bras rebatibles
Heizgerät Arme ausklappbar
Heating lamp arms fold-away
Aquecedora braços rebatíveis

Ref	€	W	U.Venta
69423	199,51	2000	1

Ref	Tensión/Voltage	Potencia/Power	IP	Calent./Heating	Dimensiones/Sizes	Peso/Weight
69420	220-240 V, 50/60 Hz	1500 W	IP24	Lámp. calentamiento Halógeno infrarrojos	Ø42,5x25 cm	2,40 Kg
69421	220-240 V, 50/60 Hz	900/1200/2100 W	IP24	Halogen infrared heating lamp	Ø58,5x35 cm	2,75 Kg
69423	220-240 V, 50/60 Hz	2000 W	IP34	Halogen infrared heating lamp	Ø100x8,5 cm	3,60 Kg

CALENTADORES PARED

New



Soporte abierto - Support open: 28,5 cm
Soporte cerrado - Support closed: 17 cm

Calefactor de fibra de carbono de alta eficiencia
Incluye un soporte de pared con regulación angular
 High Efficiency Carbon Fibre Heating
 Includes a wall bracket with angular adjustment



Con control remoto
 With remote control

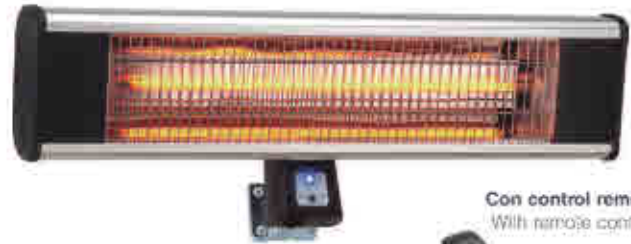

Con control remoto
 With remote control

AL

Aluminium

Calefactor de pared

Chauffe de mur
 Heizung, Hängeleiste
 Wall lamp
 Aquecedora de parede

Área de calentamiento Heating area

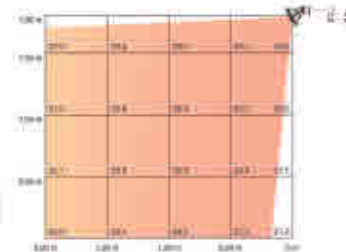

ABS

Plastic

AL

Aluminium

Calefactor eléctrico de pared

Chauffe électrique de mur
 Elektrische Heizung, Hängeleiste
 Wall electric lamp
 Aquecedora eléctrica de parede

Ref	€	W	U.Venta
69424	259,89	1500	1

Ref	€	W	U.Venta
69425	171,71	1800	1

Ref	Tensión/Voltage	Potencia/Power	Lámparas Lamps	N. calentamiento Heating levels	Ángulo de giro Angle of rotation	Nivel protección Protection level	Dimensiones Sizes	Peso/Weight
69424	220-240 V, 50/60 Hz	1500 W	1	1	25° (eje vertical/vertical axis)	IP55	75x13x13cm	3,60 Kg
69425	220-240 V, 50/60 Hz	1800 W	1	1	25° (eje vertical/vertical axis)	IP44	65x21,5x24,5 cm	2,40 Kg

▶ CALENTADORES GAS

Solo para uso en exteriores Only for outdoor use

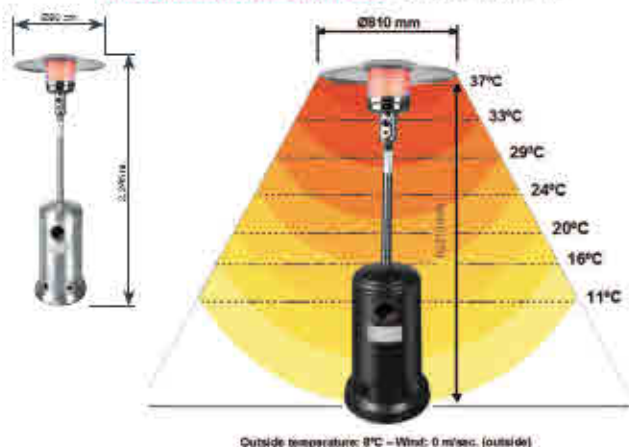

Ideal para bares y restaurantes con mesas en el exterior.
Indicado única y exclusivamente para exteriores.
Disponibile en dos acabados diferentes: Acero inoxidable - Negro.
Malla protectora para evitar quemadura.

Idéal pour les bars et les restaurants ayant des tables à l'extérieur.
Destiné uniquement et exclusivement pour un usage en extérieur.
Disponible en deux finitions différentes: Acier inoxydable - Noir.
Maille de protection pour éviter les brûlures.

Idéal für Bars und Restaurants mit Tischen im Freien.
Nur für den Außenbereich geeignet.
In zwei verschiedenen Ausführungen erhältlich: Edelstahl - Schwarz.
Schutzgitter zum Vermeiden von Verbrennungen.

Idéal for bars and restaurants with tables outside.
Exclusively for outdoor use.
Available in two different finishes: Stainless steel - Black.
Protective mesh to prevent burns.

Idéal para bares e restaurantes com mesas no exterior.
Indicado única e exclusivamente para exteriores.
Disponível em dois acabamentos diferentes: aço inoxidável e preto.
Rede protectora para evitar queimaduras.

Accesorios

Accessoires - Zubehör - Accessories - Acessórios



Calentador terraza a gas
Chauffage de terrasse à gaz
Gas-Terrassenheizstrahler
Outdoor gas heater
Aquecedor a gás para terraços

Ref	€	U.Venta	
69400	320,69	1	España
69400F	320,69	1	Francia
69400P	320,69	1	Portugal
69401	242,57	1	España
69401F	242,57	1	Francia
69401P	242,57	1	Portugal

A

B

PE

Polietileno

Funda para calentador terraza a gas
Housse pour chauffage de terrasse à gaz
Abdeckung für Gas-Terrassenheizstrahler
Cover for outdoor gas heater
Capa protectora para aquecedor a gás para terraços

Ref	€	U.Venta
R69400N	14,11	1



A

B



Jgo. ruedas acero para calentador terraza
Ensemble de roues pour chauffage de terrasse à gaz
Rollen für Gas-Terrassenheizstrahler
Wheel set for outdoor gas heater
Jogo de rodas para aquecedor a gás para terraços

Ref	€	U.Venta
A R69400S	9,03	1
B R69400R	9,03	1

Ref	Potencia/Power	Posición piloto/Pilot posit.	Altura/Height	Peso/Weight
69400	14 KW (max)	870 g/h	2,245 m	20 Kg
69401	14 KW (max)	870 g/h	2,245 m	22 Kg

Funciona con gas propano o butano - Uses propane or butane gas only

▶ CARTELES LACOR

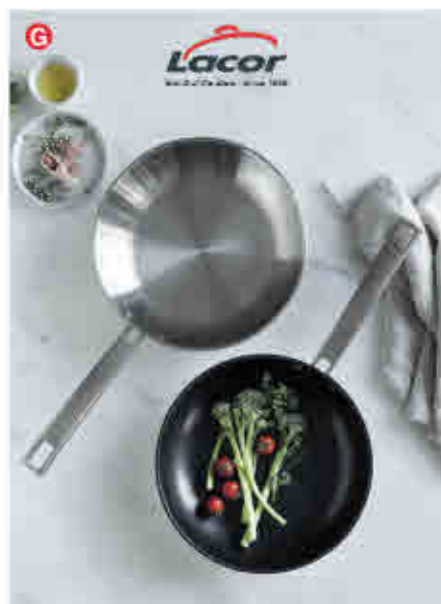
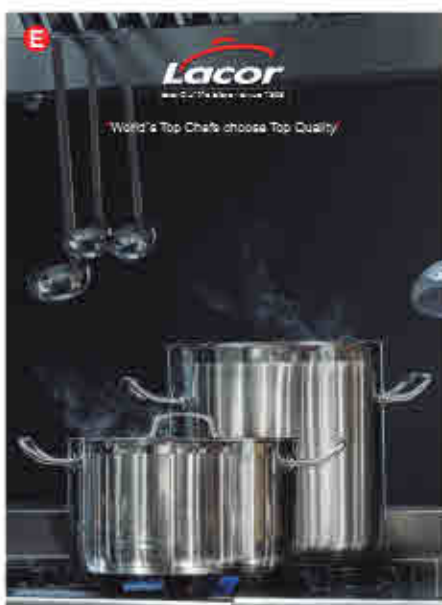
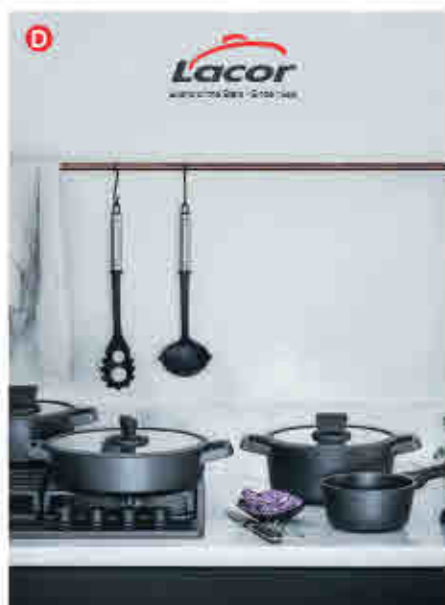

Cartei promocional
 Affiche promotionnelle
 Werbe-Plakat
 Promotional poster
 Poste promocional

	Ref	cm
A	99915	42x59,4
B	99916	42x59,4
C	99917	42x59,4
D	99918	42x59,4
E	99920	70x100
F	99921	70x100
G	99922	70x100

▶ EXPOSITORES PIE

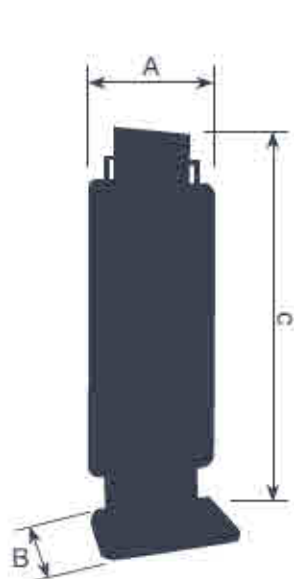

Expositor
Exposant
Aussteller
Exhibitor
Expositor

Ref	AxBxC (cm)	
A 00722	57,5x38x192,5	Bandejas Trays
B 00723	57,5x38x192,5	Ganchos Hooks
C 00724	57,5x38x192,5	Mixto Mix

▶ EXPOSITORES MESA



Expositor SLOW JUICER
Exposant
Aussteller
Exhibitor
Expositor

Ref	cm	
10025	43x39,5x50,5	ES
10026	43x39,5x50,5	FR
10027	43x39,5x50,5	EN

* **NOTA: El expositor se manda vacío**
REMARQUE: L'exposant est envoyé vide
HINWEIS: Der Aussteller ist leer gesendet
NOTE: The exhibitor is sent empty
* **NOTA: El expositor se manda vacío**



Expositor MENU
Exposant
Aussteller
Exhibitor
Expositor

Ref	cm
00725	36x26x42,5

* **NOTA: El expositor se manda vacío**
REMARQUE: L'exposant est envoyé vide
HINWEIS: Der Aussteller ist leer gesendet
NOTE: The exhibitor is sent empty
* **NOTA: El expositor se manda vacío**



Índice

•

Sommaire

•

Index

•

Index

•

Índice

Ref	Pag	Ref	Pag	Ref	Pag	Ref	Pag	Ref	Pag
00722	533	20037	26	20945	28	23640	72	25816	49
00723	533	20038	26	20950	28	23641	73	25820	49
00724	533	20039	26	20960	28	23724	98	25823	49
00725	533	20040	26	21216	27	23728	98	25824	49
4000	462	20041	26	21220	27	23732	98	25825	49
10004	378	20045	26	21224	27	23736	98	25827	49
10025	533	20046	26	21228	27	23740	98	25828	49
10026	533	20050	26	21618	71	23816	72	25829	49
10027	533	20051	26	21620	71	23818	72	25830	49
10330	377	20060	26	21622	71	23820	72	25831	49
10430	377	20061	26	21624	71	23822	72	25832	49
11330	377	20120	27	21626	71	23824	72	25835	49
11430	377	20124	27	21628	71	23826	72	25840	58,190
12406	417	20128	27	21632	71	23828	72	25841	58,190
12407	417	20130	27	21636	71	23830	73	25842	58,190
12408	417	20132	27	21640	71	23832	72	25843	59,191
14012	205	20134	27	21718	71	23836	72	25845	59,191
14013	208	20136	27	21720	71	23840	72	25846	59,191
14016	126,384	20138	27	21722	71	23900	77,94	25847	59,191
14019	126,384	20140	27	21724	71	24120	78	25848	58,190
14025	126,384	20145	27	21726	71	24122	78	25849	58,190
14027	159	20150	27	21728	71	24123	79	25850	58,190
14029	126,384	20160	27	21732	71	24124	78	25851	58,190
14033	126,384	20216	27	21736	71	24125	79	25852	58,190
14042	159	20217	27	22718	71	24126	78	25853	59,191
14050	159	20220	27	22720	71	24127	79	25855	59,191
14065	208	20221	27	22722	71	24128	78	25856	59,191
14100	159	20224	27	22724	71	24129	79	25857	59,191
14114	126	20225	27	22726	71	24134	79	25858	58,190
14119	126	20228	27	22728	71	24135	79	25859	58,190
14121	237	20229	27	22732	71	24136	79	25871	60,192
14122	128	20337	28	22736	71	24137	79	25872	60,192
14124	126	20341	28	23120	70	24138	78	25873	60,192
14125	128	20470	28	23124	70	24720	83	25874	61,193
14128	126	20511	66	23126	70	24722	83	25875	61,193
14130	128	20515	66	23128	70	24724	83	25876	61,193
14135	159	20518	66	23132	70	24726	83	25877	61,193
14136	159	20522	66	23136	70	24728	83	25881	60,192
14145	159	20533	66	23322	73	24732	83	25882	60,192
14205	48	20551	28	23323	76	24918	82	25883	60,192
14212	48	20561	28	23326	73	24920	82	25909	57,189
14214	48	20628	27,98	23327	76	24922	82	25910	57,189
14216	48	20630	27,98	23330	73	24924	82	25911	57,189
14218	48	20632	27,98	23416	71	24926	82	25912	57,189
14220	48	20634	27,98	23418	71	24928	82	25914	57,189
14318	48	20636	27,98	23420	71	25132	97	25915	57,189
14320	48	20638	27,98	23422	71	25432	79,97	25916	57
14322	48	20640	27,98	23424	71	25436	79,97	25917	57
14324	48	20645	27,98	23426	71	25440	79,97	25920	57
14420	48	20650	27,98	23428	71	25525	81	25921	57
14422	48	20660	27,98	23432	71	25529	81	25924	57
14424	48	20716	27	23436	71	25534	89	25925	57
20020	26	20720	27	23612	73	25536	79	25927	57
20021	26	20830	65	23614	73	25539	89	25928	57
20024	26	20840	65	23616	72	25547	79	25929	57
20025	26	20850	65	23618	72	25771	60,192	25931	57
20028	26	20920	28	23620	72	25772	60,192	25933	57
20029	26	20924	28	23622	72	25773	60,192	25935	57
20030	26	20928	28	23624	72	25774	61,193	26400	83
20031	26	20930	28	23626	72	25775	61,193	26418	84
20032	26	20932	28	23628	72	25776	61,193	26420	84
20033	26	20934	28	23632	72	25777	61,193	26422	84
20034	26	20936	28	23636	72	25781	60,192	26424	84
20035	26	20938	28	23637	73	25782	60,192	26426	84
20036	26	20940	28	23638	73	25783	60,192	26428	84

Ref	Pag	Ref	Pag	Ref	Pag	Ref	Pag	Ref	Pag
26430	84	28051	269	28353	270	32714	41	39043	113,298
26718	84	28052	269	28371	266	32716	41	39044	113,298
26720	84	28053	269	28372	266	32916	41	39047	113,298
26722	84	28061	271	28373	266	32920	41	39048	113,298
26724	84	28062	271	28375	266	32924	41	39060	298
26726	84	28063	271	28376	266	32928	41	39061	298
26728	84	28081	274	28391	265	33101	311	39064	298
26730	84	28082	274	28392	265	33102	311	39065	302
26818	80	28083	274	28395	266	33103	311	39075	299
26820	80	28101	272	28396	277	33104	311	39108	301
26822	80	28102	272	28400	262	33105	311	39109	301
26824	80	28103	272	28401	262	33106	311	39110	296
26826	80	28121	277	28402	262	33107	311	39112	296
26828	80	28122	277	28403	262	33108	311	39114	296
26830	80	28123	277	28404	262	33109	311	39115	296
26834	80	28131	277	28405	262	33110	311	39116	296
26838	80	28132	277	28411	263	33111	311	39118	296
26844	80	28133	277	28412	263	33112	311	39121	296
26848	80	28141	270	28413	263	33113	311	39124	523
26858	80	28151	268	28421	263	33114	311	39125	296
27320	55	28161	270	28422	263	33116	311	39126	526
27324	55	28172	268	28423	263	33124	311	39127	526
27327	55	28175	264	28431	263	33125	311	39128	525
27328	55	28176	264	28432	263	33126	311	39129	525
27416	55	28177	265	28433	263	33401	311	39133	526
27418	55	28182	271	28441	264	33402	311	39135	524
27420	51	28190	261	28442	264	33403	311	39137	525
27424	51	28191	261	28443	264	33404	311	39138	526
27428	51	28192	261	28500	273	33405	311	39139	526
27432	51	28195	261	28501	273	33406	311	39140	255,521
27436	51	28196	261	28502	273	33407	311	39160	255,521
27516	51	28197	261	28510	267	33408	311	39161	255,521
27520	51	28198	261	28511	267	33409	311	39162	254
27524	51	28199	261	28512	267	33410	311	39163	254
27528	51	28200	261	28520	272	33411	311	39164	254
27620	55,82	28205	261	28521	272	33412	311	39165	294
27624	55,82	28206	261	28522	272	33413	311	39166	254
27625	55,82	28211	276	28530	269	33414	311	39169	294
27626	55,82	28212	276	28531	269	33415	311	39170	294
27628	55,82	28213	276	28532	269	33416	311	39171	294
27629	55,82	28231	275	28540	271	38010	300	39172	294
27728	51	28232	275	28550	274	38393	265	39185	296
27732	51	28233	275	28560	273	39000	297	39208	299
27736	51	28241	275	32000	41	39001	297	39210	299
27820	51,81	28242	275	32003	41	39004	298	39212	299
27824	51,81	28243	275	32016	40	39008	301	39213	299
27827	51,81	28261	276	32020	40	39009	301	39215	299
27828	51,81	28262	276	32024	40	39010	297	39218	299
27832	51,81	28263	276	32028	40	39012	523	39266	302
27920	55	28271	274	32116	40	39014	296	39402	253,253
27924	55	28272	274	32120	40	39015	297	39403	253
27928	55	28273	274	32124	40	39016	296	39404	253
28001	276	28281	275	32125	40	39017	297	39405	255
28002	276	28282	275	32128	40	39018	297	39406	255
28003	276	28283	275	32129	40	39020	296	39407	255
28011	273	28311	272	32214	40	39021	296	39410	255
28012	273	28321	269	32216	40	39023	296	39411	255
28013	273	28331	264	32218	40	39024	296	39413	253
28021	267	28332	264	32220	40	39025	296	39414	253
28022	267	28333	264	32318	41	39027	296	39415	255
28023	267	28341	265	32324	41	39028	297	39420	255
28031	267	28342	265	32420	41	39030	296	39423	253
28032	267	28343	265	32424	41	39040	214	39424	253
28033	267	28351	270	32624	41	39041	214	39430	255
28041	268	28352	270	32628	41	39042	214	39433	253

Ref	Pag	Ref	Pag	Ref	Pag	Ref	Pag	Ref	Pag
39434	253	40924	37	49024	295	50327	126	50934	64
39441	256	40926	37	49025	295	50328	129	50936	23
39445	256	40928	37	49027	295	50332	128	50940	23
39450	256	40932	37	49030	295	50333	126	50945	23
39451	256	40936	37	49110	295	50334	129	50950	23
39455	256	40940	37	49112	295	50336	128	50960	23
39460	256	45016	30	49116	295	50337	126	51216	23
40000	37	45018	30	49121	295	50338	129	51218	23
40016	36	45020	30	49185	295	50340	128	51220	23
40018	36	45022	30	49210	295	50341	126	51222	23
40020	36	45024	30	49212	295	50428	21,127	51224	23
40022	36	45026	30	49216	295	50432	21,127	51620	69
40024	36	45028	30	50016	21	50437	127	51621	69
40026	36	45116	30	50017	22	50438	128	51624	69
40028	36	45118	30	50020	21	50440	127	51625	69
40032	36	45120	30	50021	22	50441	127	51628	69
40036	36	45122	30	50024	21	50445	127	51629	69
40040	36	45124	30	50025	22	50450	128	51632	69
40116	36	45126	30	50028	21	50460	127	51633	69
40118	36	45128	30	50029	22	50540	23,88	51636	69
40120	36	45214	31	50032	21	50541	128	51637	69
40121	36	45216	31	50033	22	50550	23,88	51640	69
40122	36	45218	31	50036	21	50551	128	51641	69
40124	36	45220	31	50037	22	50560	23,88	51720	69
40125	36	45320	31,86	50040	21	50561	128	51724	69
40126	36	45324	31,86	50041	22	50570	23,88	51728	69
40128	36	45328	31,86	50045	21	50624	22,96	51732	69
40129	36	45420	31,86	50046	22	50625	23	51736	69
40132	36	45424	31,86	50050	21	50628	22,96	51740	69
40133	36	45428	31,86	50051	22	50629	23	53016	46
40136	36	45624	31	50060	21	50632	22,96	53018	46
40140	36	45626	31	50061	22	50633	23	53020	46
40212	36	45628	31	50116	22	50636	22,96	53024	46
40214	36	45916	31	50119	22	50637	23	53214	46
40216	36	45918	31	50120	22	50640	22,96	53216	46
40218	36	45920	31	50123	22	50645	22,96	53218	46
40220	36	45922	31	50124	22	50650	22,96	53220	46
40318	37	45924	31	50127	22	50660	22,96	53625	47
40324	37	45926	31	50128	22	50717	23	53720	47,85
40420	37	45928	31	50131	22	50721	23	53721	47,85
40424	37	48016	53	50132	22	50815	64	53724	47,85
40426	37	48020	53	50135	22	50816	64	53725	47,85
40428	37	48024	53	50136	22	50818	64	53728	47,85
40619	37,86	48028	53	50139	22	50819	64	53729	47,85
40620	37	48116	53	50140	22	50823	64	53828	47,85
40621	37,86	48120	53	50145	22	50824	64	53829	47,85
40622	37	48124	53	50150	22	50828	126	53836	328,460
40623	37,86	48128	53	50160	22	50829	128	53916	47
40624	37	48214	53	50212	23	50832	126	53918	47
40625	37,86	48216	53	50214	23	50833	128	53920	47
40626	37	48218	53	50216	23	50836	126	53924	47
40627	37,86	48220	53	50217	23	50837	128	54020	18
40628	37	48624	53	50218	23	50840	126	54021	18
40629	37,86	48628	53	50219	23	50841	128	54024	18
40632	37	48720	53,81	50220	23	50845	126	54025	18
40636	37	48724	53,81	50221	23	50846	128	54028	18
40640	37	48728	53,81	50224	23	50850	126	54029	18
40712	37	48916	53	50225	23	50851	128	54032	18
40714	37	48920	53	50228	23	50916	23	54033	18
40716	37	48924	53	50229	23	50918	23	54036	18
40718	37	48928	53	50300	126	50920	23	54037	18
40916	37	49014	295	50301	378	50924	23	54040	18
40918	37	49016	295	50320	129	50928	23	54041	18
40920	37	49017	295	50323	126	50932	23	54045	18
40922	37	49021	295	50324	129	50933	64	54046	18

Ref	Pag	Ref	Pag	Ref	Pag	Ref	Pag	Ref	Pag
54050	18	55416	361	55481	361	55546	362	55611	362
54051	18	55417	361	55482	361	55547	362	55612	362
54119	19	55418	361	55483	361	55548	362	55613	362
54120	19	55419	361	55484	361	55549	362	55614	362
54123	19	55420	361	55485	361	55550	362	55615	362
54124	19	55421	361	55486	361	55551	362	55616	362
54127	19	55422	361	55487	361	55552	362	55617	362
54128	19	55423	361	55488	361	55553	362	55618	362
54131	19	55424	361	55489	361	55554	362	55619	362
54132	19	55425	361	55490	361	55555	362	55620	362
54135	19	55426	361	55491	361	55556	362	55621	362
54136	19	55427	361	55492	361	55557	362	55622	362
54139	19	55428	361	55493	361	55558	362	55623	362
54140	19	55429	361	55494	361	55559	362	55624	362
54145	19	55430	361	55495	361	55560	362	55625	362
54150	19	55431	361	55496	361	55561	362	55626	362
54212	19	55432	361	55497	361	55562	362	55627	362
54214	19	55433	361	55498	361	55563	362	55628	362
54216	19	55434	361	55499	361	55564	362	55629	362
54217	19	55435	361	55500	361	55565	362	55630	362
54218	19	55436	361	55501	361	55566	362	55631	365
54219	19	55437	361	55502	361	55567	362	55632	365
54220	19	55438	361	55503	361	55568	362	55633	365
54221	19	55439	361	55504	361	55569	362	55634	365
54224	19	55440	361	55505	361	55570	362	55635	365
54225	19	55441	361	55506	361	55571	362	55636	365
54228	19	55442	361	55507	361	55572	362	55637	365
54229	19	55443	361	55508	361	55573	362	55638	365
54621	20	55444	361	55509	361	55574	362	55639	365
54625	20	55445	361	55510	361	55575	362	55640	365
54629	20	55446	361	55511	361	55576	362	55641	365
54633	20	55447	361	55512	361	55577	362	55642	365
54636	19,96	55448	361	55513	361	55578	362	55643	365
54637	20	55449	361	55514	361	55579	362	55644	365
54640	19,96	55450	361	55515	361	55580	362	55645	365
54645	19,96	55451	361	55516	361	55581	362	55646	365
54650	19,96	55452	361	55517	361	55582	362	55647	365
54916	20	55453	361	55518	361	55583	362	55648	365
54920	20	55454	361	55519	361	55584	362	55649	365
54924	20	55455	361	55520	362	55585	362	55650	365
54928	20	55456	361	55521	362	55586	362	55651	365
54932	20,64	55457	361	55522	362	55587	362	55652	365
54936	20	55458	361	55523	362	55588	362	55653	365
54940	20	55459	361	55524	362	55589	362	55654	365
54945	20	55460	361	55525	362	55590	362	55655	365
54950	20	55461	361	55526	362	55591	362	55656	365
55216	20	55462	361	55527	362	55592	362	55657	365
55220	20	55463	361	55528	362	55593	362	55658	365
55224	20	55464	361	55529	362	55594	362	55659	365
55400	360	55465	361	55530	362	55595	362	55660	365
55401	360	55466	361	55531	362	55596	362	55661	365
55402	360	55467	361	55532	362	55597	362	55662	365
55403	360	55468	361	55533	362	55598	362	55663	365
55404	360	55469	361	55534	362	55599	362	55664	365
55405	360	55470	361	55535	362	55600	362	55665	365
55406	360	55471	361	55536	362	55601	362	55666	365
55407	360	55472	361	55537	362	55602	362	55667	365
55408	360	55473	361	55538	362	55603	362	55668	365
55409	361	55474	361	55539	362	55604	362	55669	365
55410	361	55475	361	55540	362	55605	362	55670	365
55411	361	55476	361	55541	362	55606	362	55671	365
55412	361	55477	361	55542	362	55607	362	55672	365
55413	361	55478	361	55543	362	55608	362	55673	365
55414	361	55479	361	55544	362	55609	362	55674	365
55415	361	55480	361	55545	362	55610	362	55675	365

Ref	Pag	Ref	Pag	Ref	Pag	Ref	Pag	Ref	Pag
55676	365	55756	363	55821	364	55886	364	55951	366
55677	365	55757	363	55822	364	55887	364	55952	366
55678	365	55758	363	55823	364	55888	364	55953	366
55679	365	55759	363	55824	364	55889	364	55954	366
55680	365	55760	363	55825	364	55890	364	55955	366
55681	365	55761	363	55826	364	55891	364	55956	366
55682	365	55762	363	55827	364	55892	364	55957	366
55683	365	55763	363	55828	364	55893	364	55958	366
55684	365	55764	363	55829	364	55894	364	55959	366
55700	360	55765	363	55830	364	55895	364	55960	366
55701	360	55766	363	55831	364	55896	364	55961	366
55702	360	55767	363	55832	364	55897	364	55962	366
55703	360	55768	363	55833	364	55898	364	55963	366
55704	360	55769	363	55834	364	55899	364	55964	366
55705	360	55770	363	55835	364	55900	364	55965	366
55706	360	55771	363	55836	364	55901	364	55966	366
55707	360	55772	363	55837	364	55902	364	55967	366
55708	360	55773	363	55838	364	55903	364	55968	366
55709	363	55774	363	55839	364	55904	364	55969	366
55710	363	55775	363	55840	364	55905	364	55970	366
55711	363	55776	363	55841	364	55906	364	55971	366
55712	363	55777	363	55842	364	55907	364	55972	366
55713	363	55778	363	55843	364	55908	364	55973	366
55714	363	55779	363	55844	364	55909	364	55974	366
55715	363	55780	363	55845	364	55910	364	55975	366
55716	363	55781	363	55846	364	55911	364	55976	366
55717	363	55782	363	55847	364	55912	364	55977	366
55718	363	55783	363	55848	364	55913	364	55978	366
55719	363	55784	363	55849	364	55914	364	55979	366
55720	363	55785	363	55850	364	55915	364	55980	366
55721	363	55786	363	55851	364	55916	364	55981	366
55722	363	55787	363	55852	364	55917	364	55982	366
55723	363	55788	363	55853	364	55918	364	55983	366
55724	363	55789	363	55854	364	55919	364	55984	366
55725	363	55790	363	55855	364	55920	364	56007	358
55726	363	55791	363	55856	364	55921	364	56008	358
55727	363	55792	363	55857	364	55922	364	56009	358
55728	363	55793	363	55858	364	55923	364	56010	358
55729	363	55794	363	55859	364	55924	364	56011	358
55730	363	55795	363	55860	364	55925	364	56012	358
55731	363	55796	363	55861	364	55926	364	56013	358
55732	363	55797	363	55862	364	55927	364	56014	358
55733	363	55798	363	55863	364	55928	364	56015	358
55734	363	55799	363	55864	364	55929	364	56212	353
55735	363	55800	363	55865	364	55930	364	56216	353
55736	363	55801	363	55866	364	55931	366	56302	358
55737	363	55802	363	55867	364	55932	366	56317	358
55738	363	55803	363	55868	364	55933	366	56320	358
55739	363	55804	363	55869	364	55934	366	56321	359
55740	363	55805	363	55870	364	55935	366	56322	359
55741	363	55806	363	55871	364	55936	366	56325	359
55742	363	55807	363	55872	364	55937	366	56330	358
55743	363	55808	363	55873	364	55938	366	56412	353
55744	363	55809	363	55874	364	55939	366	56416	353
55745	363	55810	363	55875	364	55940	366	56435	359
55746	363	55811	363	55876	364	55941	366	56502	359
55747	363	55812	363	55877	364	55942	366	56507	359
55748	363	55813	363	55878	364	55943	366	56508	359
55749	363	55814	363	55879	364	55944	366	56509	359
55750	363	55815	363	55880	364	55945	366	56510	359
55751	363	55816	363	55881	364	55946	366	56511	359
55752	363	55817	363	55882	364	55947	366	56512	359
55753	363	55818	363	55883	364	55948	366	56513	359
55754	363	55819	363	55884	364	55949	366	56514	359
55755	363	55820	364	55885	364	55950	366	56515	359

Ref	Pag	Ref	Pag	Ref	Pag	Ref	Pag	Ref	Pag
56517	359	57916	25	60139	99	60352	282	60455	309
56520	359	57920	25	60141	99	60353	282	60456	309
56522	358	57924	25	60142	97	60354	282	60457	309
56523	358	57928	25	60144	99	60356	291	60458	310
56524	359	57932	25	60146	97	60357	291	60459	308
56525	359	57936	25	60149	99	60359	303,523	60460	290
56526	359	57940	25	60150	97	60365	286	60461	116
56527	359	58012	222	60151	99	60366	280	60462	116
57007	358	58025	222	60155	97	60367	280	60463	116
57008	358	58050	217	60159	99	60368	280	60464	116
57009	358	58060	222	60160	97	60369	280	60465	116
57010	358	58090	222	60161	99	60372	280	60467	116
57011	358	58150	217	60170	61,196	60377	280	60468	116
57012	358	58151	217	60172	61,196	60378	280	60469	116
57013	358	58152	217	60175	61,196	60380	280	60470	309
57014	358	58250	217	60180	61,196	60381	280	60471	309
57015	358	58251	217	60228	97	60386	298	60472	309
57016	24	58252	217	60232	97	60387	133	60473	309
57017	24	60000	286	60236	97	60388	283	60474	309
57020	24	60001	300	60240	97	60389	283	60475	309
57021	24	60002	102	60253	138	60390	137	60476	309
57024	24	60003	102	60255	138	60391	137	60477	309
57025	24	60004	287	60298	285	60392	283	60478	309
57028	24	60005	287	60299	285	60393	283	60479	309
57029	24	60006	416	60300	129	60397	286	60480	309
57032	24	60007	416	60301	288	60398	280	60481	309
57033	24	60008	416	60302	288	60399	280	60485	304
57036	24	60009	287	60303	288	60401	135	60487	304
57037	24	60010	93	60305	289	60402	130	60488	304
57040	24	60011	93	60306	102	60403	135	60491	304
57041	24	60013	126,384	60307	289	60404	117	60492	304
57116	25	60014	93	60308	102	60405	309	60495	304
57120	25	60016	126,384	60309	102	60406	309	60497	137
57124	25	60017	93	60310	102	60407	309	60498	137
57128	25	60018	300	60311	129	60408	102	60499	285
57132	25	60019	300	60312	102	60409	103	60500	308
57136	25	60020	126,384	60313	129	60410	102	60501	308
57140	25	60021	131	60314	102	60411	103	60502	308
57212	25	60022	300	60315	129	60412	102	60503	308
57214	25	60023	300	60316	102	60413	103	60507	102
57216	25	60024	126,384	60317	129	60414	102	60508	102
57217	25	60026	131	60318	129	60415	103	60509	102
57218	25	60027	131	60319	130	60416	102	60510	292
57219	25	60028	126,384	60320	129	60417	103	60511	293
57220	25	60030	131	60321	130	60419	103	60512	135
57221	25	60031	131	60322	129	60420	116	60513	292
57224	25	60032	126,384	60323	130	60421	116	60514	135
57225	25	60034	93	60324	129	60422	116	60516	135
57302	358	60036	126,384	60325	130	60423	103	60517	135
57317	358	60040	126,384	60326	129	60424	117	60518	135
57320	358	60048	131	60327	247	60425	116	60520	103
57321	359	60052	93	60329	134	60426	115	60521	309
57322	359	60059	300	60331	291	60427	103	60522	309
57325	359	60060	300	60332	291	60429	117,287	60524	284
57330	358	60061	300	60334	134	60430	115	60527	284
57435	359	60062	92	60335	134	60431	133	60528	284
57624	25,96	60068	92	60336	287	60432	133	60529	284
57625	25	60070	93	60340	134	60434	115	60546	282
57628	25,96	60072	305	60343	293	60435	116	60547	282
57629	25	60127	99	60346	282	60438	116	60569	309
57632	25,96	60130	97	60347	282	60442	116	60570	309
57636	25,96	60131	99	60348	127	60443	116	60571	309
57640	25,96	60134	97	60349	127	60444	282	60572	309
57717	25	60135	99	60350	286	60445	116	60573	309
57721	25	60138	97	60351	282	60446	116	60574	309

Ref	Pag	Ref	Pag	Ref	Pag	Ref	Pag	Ref	Pag
60575	309	61025	206	61140	187,335	61615	120,387	61830	158
60576	309	61029	161	61141	245	61620	120,387	61831	158
60577	309	61030	93	61308	102	61621	120,387	61832	159
60578	307	61031	161	61310	102	61622	120,387	61835	158
60580	306	61033	92	61312	102	61623	120,387	61836	158
60581	306	61034	92	61316	103	61624	121,387	61838	159
60582	306	61036	93	61318	103	61625	120,387	61840	158
60583	307	61041	161	61319	237	61626	120,387	61841	159
60584	307	61042	198	61320	103	61627	121,387	61843	159
60585	307	61043	161	61321	237	61629	121,387	61845	158
60586	307	61044	161	61322	103	61630	120,387	61848	159
60587	307	61045	198	61326	103	61631	120,387	61850	158
60588	307	61046	198	61330	103	61634	121,387	61860	158
60591	305	61047	198	61335	103	61635	120,387	61871	158
60592	305	61048	198	61341	289	61636	120,387	61880	158
60593	310	61049	198	61342	289	61639	121,387	61881	158
60594	305	61051	161	61343	289	61640	120,387	61901	201
60600	309	61052	195	61344	289	61641	120,387	61903	204
60601	309	61053	196	61346	289	61644	121,387	61904	204
60602	309	61055	196	61347	289	61645	120,387	61905	204
60603	309	61056	196	61348	289	61646	120,387	61906	204
60604	309	61057	197	61349	289	61649	121,387	61907	204
60605	309	61058	197	61351	287	61650	120,387	61908	201
60606	309	61059	197	61352	287	61651	120,387	61909	204
60610	121,387	61060	197	61353	283	61655	120,387	61911	201
60612	121,387	61062	195	61354	289	61660	120,387	61912	140
60700	113	61063	196	61355	283	61671	442	61913	204
60701	378	61064	161	61356	289	61672	439	61918	201
60702	378	61065	196	61359	132,285	61673	439	61920	201
60704	377	61066	196	61360	289	61674	439	61921	201
60710	113	61067	195	61361	213	61675	439	61925	140
60726	115	61069	195	61362	132	61676	439	61932	249
60731	113	61070	161	61403	147	61679	441	61935	249
60740	113	61071	161	61404	147	61681	442	61939	249
60746	113	61072	161	61405	147	61682	440	61940	140
60760	113	61073	161	61407	403	61683	440	61950	233
60761	113	61095	206	61408	139	61700	149,522	61954	124,241
60776	113	61096	206	61409	205	61702	152	61965	233
60791	113	61097	206	61410	102	61703	150	61970	140
60803	94,155	61098	206	61411	102	61705	152	61974	140,403
60804	94,155	61101	294	61412	102	61707	150	61977	140,403
60805	94,155	61102	294	61413	102	61708	151	62001	222
60812	205	61103	294	61414	91	61709	152	62003	222
60814	205	61107	195	61415	205	61710	152	62010	222
60818	205	61109	195	61416	139	61711	152	62023	222
60823	205	61110	160	61418	139	61712	151	62035	222
60825	205	61112	195	61420	147	61714	152	62051	220
60829	205	61113	160	61421	117	61715	152	62054	220
60922	205	61116	160	61424	205	61716	149,522	62056	220
60924	205	61121	160	61425	147	61717	150	62060	222
60928	205	61122	160	61430	205	61721	151	62071	220
61001	207,378	61126	186,334	61460	117	61722	151	62074	220
61002	207,378	61127	186,334	61461	117	61725	151	62076	220
61004	207	61128	186,334	61481	117	61730	149,522	62081	220
61007	195	61129	185	61524	121,387	61735	151	62084	220
61008	206	61130	185	61529	121,387	61740	151	62086	220
61009	195	61131	185	61530	88	61813	145	62110	222
61010	161	61132	185	61534	121,387	61815	145	62115	222
61012	206	61133	139	61535	88	61816	145	62120	222
61015	161	61134	139	61539	121,387	61817	145	62135	222
61016	161	61135	139	61540	88	61820	158	62153	221
61019	161	61136	139	61545	88	61821	187	62160	222
61021	161	61137	186,334	61550	88	61823	187	62163	221
61023	206	61138	186,334	61608	123	61825	158	62168	221
61024	93	61139	186,334	61610	201	61828	159	62180	221

Ref	Pag	Ref	Pag	Ref	Pag	Ref	Pag	Ref	Pag
62183	221	62368	240	62495	153	62630	106	62824	202
62186	221	62371	240	62496	230	62673	281	62825	158
62210	222	62373	240	62498	154	62675	281	62830	158
62215	222	62374	210	62500	112,154	62676	281	62835	158
62216	222	62380	206	62503	107	62677	115	62840	158
62220	222	62382	200	62504	107	62680	130	62841	159
62225	222	62384	200	62505	107	62683	281	62845	158
62235	222	62388	247	62506	107	62684	214,281	62850	158
62252	201	62389	236	62507	107	62685	281	62862	200
62260	222	62391	241	62512	130	62686	281	62864	200
62261	244	62392	241	62513	130	62687	281	62866	200
62262	244	62393	241	62515	130	62688	281	62867	200
62263	244	62394	205	62516	130	62689	281,303	62892	133
62264	244	62399	211	62519	152,385	62690	130	62901	121,387
62265	244	62406	205	62521	130	62691	130	62902	133
62266	244	62409	203	62522	231	62692	130	62903	203
62267	245	62410	231	62523	231	62697	130	62904	203
62268	245	62414	246	62524	130	62698	130	62905	203
62271	237	62415	231	62525	200	62702	241	62906	203
62272	237	62424	205	62528	112,154	62715	241	62908	214
62273	237	62430	231	62530	88	62716	241	62912	136
62274	240	62435	113	62531	130	62720	241	62913	208
62275	240	62436	237	62532	155	62721	241	62916	208
62276	235	62438	246	62533	155	62725	241	62924	212
62277	235	62439	237	62535	88	62726	241	62926	212
62278	248	62440	232	62536	233	62750	125,384	62928	214
62279	248	62441	232	62537	233	62751	170	62929	212
62280	325	62442	232	62538	233	62753	170	62930	212
62281	325	62443	232	62540	88	62754	170	62931	212
62283	325	62444	232	62541	324	62755	170	62933	212
62300	236	62445	113	62542	324	62756	170	62938	214
62302	249	62446	113	62545	324	62757	170	62939	212
62306	211,247	62448	232	62546	233	62758	170	62940	212
62307	210	62450	153	62547	233	62759	170	62941	208
62315	237	62452	153	62548	233	62761	170	62942	137
62317	211,404	62453	153	62551	200	62762	170	62943	137
62318	210	62454	153	62555	200	62764	170	62944	335
62320	237	62456	154	62563	230	62766	170	62946	136
62321	237	62457	154	62564	230	62768	170	62951	206
62322	237	62458	153	62575	230	62769	170	62952	136
62325	235	62459	153	62576	232	62770	170	62954	213
62326	248	62460	231	62577	232	62771	170	62955	213
62329	248	62461	199	62578	232	62772	170	62956	213
62330	248	62462	199	62579	230	62780	171	62957	103
62334	211	62463	199	62601	106	62781	171	62958	127
62336	237	62464	199	62603	106	62782	171	62959	103
62337	211,247	62465	199	62604	106	62783	171	62962	113
62338	236	62466	199	62605	106	62784	171	62963	113
62341	248	62470	199	62606	106	62785	171	62964	352
62342	236	62472	232,323	62607	106	62786	171	62970	205
62344	310	62473	232,323	62608	106	62787	171	62971	205
62346	237	62475	232,323	62609	106	62790	171	62972	103
62352	249	62476	232	62610	130	62791	170	62973	213
62353	210	62477	232	62611	130	62792	170	62974	214
62354	240	62478	236	62612	130	62793	170	62976	214
62355	235	62479	236	62613	130	62797	171	62977	211,247
62356	236	62480	232	62614	130	62811	106	62978	210
62359	310	62481	231	62615	130	62812	106	62980	134
62361	240	62483	231	62616	130	62814	203	62981	210
62362	240	62484	231	62617	130	62816	203	62982	210
62363	247	62485	231	62618	130	62817	202,217	62983	212
62364	240	62486	231	62619	130	62818	203	62984	212
62365	240	62487	153	62620	130	62820	158	62985	211
62366	240	62491	230	62621	130	62821	213	62986	210
62367	240	62492	230	62623	130	62823	203	62987	128

Ref	Pag	Ref	Pag	Ref	Pag	Ref	Pag	Ref	Pag
62988	102	63177	174	63381	177,194	63572	170	63728	74
62989	90,213,345	63178	174	63382	177,194	63573	169	63729	76
62998	90,213,345	63180	175	63383	177,194	63577	169	63731	99
63005	303	63181	175	63384	177,194	63580	170	63732	74
63008	185	63182	175	63385	177,194	63581	170	63736	74
63010	251	63183	175	63386	177,194	63582	170	63740	74
63012	251	63184	175	63387	177,194	63585	170	63741	99
63013	251	63185	175	63388	177,194	63586	169,404	63751	99
63015	303	63186	175	63389	177,194	63589	168	63761	99
63016	214	63187	176	63419	75	63599	168	63771	99
63017	214	63188	176	63423	75	63600	171	63828	76
63018	251	63189	176	63424	75	63601	171	63829	76
63019	251	63190	176	63428	75	63602	171	63830	164
63020	251	63191	176	63432	75	63603	171	63831	164
63021	251	63192	176	63461	176	63604	171	63832	164
63022	251	63215	203	63462	176	63605	171	63833	164
63026	250	63220	203	63463	176	63608	171	63834	164
63028	250	63225	203	63471	187,336	63609	169	63835	165
63031	250	63261	172	63472	187,336	63610	169	63836	165
63033	251	63262	172	63473	187,336	63611	170	63837	165
63036	185	63263	172	63474	187,336	63612	170	63838	165
63038	281,303	63264	172	63476	188,335	63613	75	63839	165
63052	249	63265	172	63477	188,335	63614	75	63840	165
63053	251	63267	172	63478	188,335	63617	169	63841	165
63054	250	63268	172	63479	188,335	63618	171	63842	165
63060	212	63269	172	63480	187,336	63619	169	63843	165
63061	212	63270	173	63481	187,336	63620	74	63844	165
63062	212	63272	173	63482	187,336	63621	98	63845	165
63063	212	63273	173	63483	235	63623	98	63846	165
63064	212	63274	173	63486	188,335	63624	74	63847	165
63065	212	63275	173	63487	188,335	63625	98	63848	165
63070	212	63279	173	63488	188,335	63626	74	63849	165
63071	212	63280	173	63489	188,335	63627	98	63850	165
63072	212	63302	207,379	63490	188,336	63628	74	63851	165
63073	212	63303	376	63494	188,336	63629	98	63852	165
63074	212	63304	206	63514	103	63631	98	63853	165
63075	212	63305	376	63516	103	63632	74	63854	165
63115	98	63306	376	63518	103	63633	98	63855	164
63130	98	63307	376	63520	103	63635	98	63856	165
63131	495	63309	376	63524	103	63636	74	63857	165
63132	495	63310	231	63528	103	63637	98	63858	165
63133	495	63312	376	63531	168	63638	171	63859	165
63137	251	63315	231	63532	168	63639	98	63860	165
63141	242	63319	376	63533	168	63640	74	63861	165
63142	242	63320	231	63534	168	63641	98	63862	165
63143	242	63331	381	63535	168	63642	76	63863	164
63144	243	63332	381	63536	168	63643	98	63864	165
63145	243	63341	381	63541	168	63644	76	63865	164
63146	243	63342	381	63542	168	63647	98	63871	187,336
63147	243	63360	231	63543	168	63648	171	63872	187,336
63148	243	63361	172	63544	168	63651	98	63873	187,336
63149	243	63362	172	63545	168	63656	98	63874	187,336
63161	174	63363	172	63546	168	63661	98	63880	187,336
63162	174	63364	172	63551	169	63666	98	63881	187,336
63163	174	63365	172	63552	169	63671	98	63882	187,336
63164	174	63367	172	63553	170	63681	98	63890	188,336
63165	174	63368	172	63554	170	63691	98	63894	188,336
63166	174	63369	172	63555	170	63700	99	63911	289
63169	174	63370	173	63556	170	63712	75	63912	136
63171	174	63372	173	63557	169	63714	75	63913	136
63172	174	63373	173	63558	169	63720	74	63914	136
63173	174	63374	173	63567	169	63724	74	63915	136
63174	174	63375	173	63568	169	63725	75	63928	75,98
63175	174	63379	173	63570	170	63726	74	63932	75,98
63176	174	63380	173	63571	170	63727	75	63936	75,98

Ref	Pag	Ref	Pag	Ref	Pag	Ref	Pag	Ref	Pag
63940	75,98	64450	119,390	66140	343	66752	185	66840	182
63941	166	64451	119,390	66142	343	66753	414	66841	182
63942	166	64457	140,403	66155	343	66755	184	66842	182
63943	166	64458	140,403	66165	343	66756	184	66844	412
63944	166	64460	119,390	66167	343	66757	184	66850	182
63945	166	64461	119,390	66202	344	66758	184	66851	182
63946	167	64463	119,391	66210	344	66759	91,414	66852	182
63947	167	64464	119,391	66212	344	66760	408	66853	182
63948	167	64465	119,391	66215	344	66761	408	66854	182
63949	167	65003	222	66217	344	66762	408	66855	182
63950	167	65004	222	66220	344	66763	409	66856	182
63951	167	65012	222	66222	344	66764	409	66857	182
63952	167	65025	222	66240	344	66765	409	66870	421
63953	167	65031	159	66242	344	66766	409	66871	421
63954	167	65035	222	66245	342	66767	409	66872	421
63955	167	65037	159	66246	342	66768	409	66873	421
63956	167	65041	159	66249	352	66769	409	66874	421
63957	167	65044	122,391	66265	344	66772	183	66875	421
63958	167	65046	159	66267	344	66773	183	66876	421
63959	167	65050	122,391	66299	351	66775	413	66877	421
63960	167	65060	222	66302	344	66776	413	66878	421
63961	167	65110	222	66310	344	66777	413	66879	421
63962	167	65118	222	66315	344	66780	183	66901	345
63963	167	65135	222	66320	344	66781	183	66902	345
63964	167	65160	222	66340	344	66782	183	66903	345
63965	167	65210	222	66349	352	66783	183	66904	345
63966	166	65215	222	66350	352	66784	184	66905	345
63967	167	65218	222	66351	352	66785	184	66907	345
63968	167	65235	222	66352	352	66787	184	66909	345
63969	167	65260	222	66353	352	66788	184	66910	345
63970	167	65414	238	66355	344	66790	183	66911	345
63971	167	65418	238	66365	344	66791	183	66912	345
63972	167	65420	238	66402	344	66792	183	66920	90,345,415
63973	167	65436	239	66410	344	66793	183	66921	90,345,415
63974	166	65440	239	66415	344	66800	410	66923	345
63975	167	65450	239	66420	344	66801	411	66925	345
63976	166	65614	238	66465	344	66802	411	66926	404
64040	103	65618	238	66502	344	66804	411	66927	404
64060	103	65620	238	66510	344	66805	411	66930	354
64407	207,379	65636	239	66515	344	66807	410	66931	355
64408	207,379	65640	239	66520	344	66808	412	66932	355
64409	207,379	65650	239	66540	344	66812	410	66933	354
64418	122,391	65925	416	66550	353	66813	410	66934	354
64422	122,391	65930	416	66555	352	66816	410	66935	355
64424	119,391	66002	343	66565	344	66817	410	66936	354
64425	122,391	66010	343	66599	351	66819	410	66937	354
64426	119,391	66012	343	66610	345	66820	410	66938	354,354
64427	119,391	66015	343	66615	345	66821	411	66939	354
64428	119,391	66017	343	66620	345	66822	411	66940	354
64429	119,391	66020	343	66642	353	66823	411	66942	354
64430	122,391	66040	343	66665	345	66824	411	66945	355
64431	122,391	66042	343	66731	91,414	66825	411	66947	355
64432	213	66065	343	66732	91,414	66826	411	66948	354
64433	213	66067	343	66733	412	66827	412	66949	354
64434	213	66099	351	66734	412	66828	412	66950	355
64435	122,391	66102	343	66735	412	66830	412	66951	355
64436	213	66104	343	66736	412	66831	181	66952	355
64437	213	66110	343	66737	412	66832	181	66953	355
64438	122,391	66112	343	66738	412	66833	181	66956	354
64439	213	66115	343	66742	412	66834	181	66958	355
64440	122,391	66116	353	66745	414	66835	182	66959	355
64441	122,391	66117	343	66746	91,414,450	66836	182	66965	345
64444	119,390	66118	353	66747	408	66837	182	66972	355
64445	119,390	66120	343	66748	409	66838	182	66974	355
64446	119,390	66122	343	66749	91,414	66839	182	66975	355

Ref	Pag	Ref	Pag	Ref	Pag	Ref	Pag	Ref	Pag
66977	355	67094	406	68040	416	68254	386	68544	423
67000	142,396	67095	406	68041	416	68270	108	68546	423
67001	385	67105	415	68043	416	68271	108	68547	423
67002	405	67131	125,384	68048	416	68272	108	68548	423
67004	117,287	67133	125,384	68049	416	68273	108	68550	423
67005	118,389	67136	125,384	68050	386	68274	108	68554	423
67006	118,389	67140	388	68052	386	68275	108	68556	423
67007	385	67141	388	68053	386	68276	108	68557	423
67008	288	67142	388	68054	386	68285	123	68560	423
67009	288	67143	388	68056	386	68286	123	68566	423
67010	125,384	67148	388	68057	386	68305	286	68567	423
67011	386	67149	388	68058	386	68306	286	68570	423
67012	247,385	67150	143,397	68060	416	68307	286	68580	423
67013	247,385	67153	406	68061	416	68308	422	68581	423
67014	247,385	67156	388	68069	392	68310	422	68587	423
67015	386	67158	406	68070	392	68340	386	68588	423
67016	247,385	67161	125,384	68078	211,224	68341	386	68590	423
67017	247,385	67163	406	68079	211,224	68342	386	68591	423
67018	247,385	67165	125,384	68080	123	68350	386	68597	423
67019	247,385	67182	288	68082	123	68351	386	68598	423
67020	247,385	67183	288	68085	130,251	68354	386	68601	248
67021	247,385	67410	103	68087	392	68357	386	68602	248
67022	247,385	67412	103	68090	389	68402	141,398	68604	141,398
67023	247,385	67414	118,389	68091	392	68403	141,398	68605	141,398
67025	386	67415	103	68092	392	68404	141,398	68607	422
67026	143,397	67417	103	68099	393	68405	141,398	68608	422
67027	117,287	67420	103	68101	133	68406	422	68609	422
67028	117,287	67421	119,390	68102	133	68407	422	68610	422
67029	118,389	67427	119,390	68107	422	68408	422	68612	422
67030	404	67433	119,390	68120	422	68410	422	68614	422
67031	288	67434	119,390	68121	422	68411	423	68616	422
67032	288	67435	119,390	68132	389	68412	422	68618	422
67034	379,461	67604	344	68136	389	68414	422	68619	224
67036	385	67610	344	68137	389	68416	422	68620	422
67037	385	67615	344	68141	388	68418	422	68622	422
67038	405	67665	344	68142	388	68420	422	68624	422
67039	405	67824	417	68150	388	68422	422	68626	422
67040	406	67828	417	68151	388	68424	422	68627	224
67043	405	67832	417	68153	388	68441	423	68628	422
67044	405	67836	417	68154	388	68460	423	68629	224
67045	405	67901	345	68161	388	68480	423	68639	224
67046	405	67902	345	68173	111	68500	141,398	68640	90,415
67047	405	67903	345	68174	111	68501	141,398	68641	90,415
67048	405	67904	345	68175	111	68502	141,398	68642	90,415
67049	405	67905	345	68176	111	68504	141,398	68643	224
67050	405	67906	345	68177	111	68505	141,398	68644	224
67051	514	67909	345	68178	111	68506	422	68650	395
67052	405	68000	419	68179	111	68508	422	68651	395,467
67053	405	68001	416	68180	132,286	68509	422	68652	395,467
67055	405	68002	416	68181	136	68510	422	68659	90,415
67056	405	68003	416	68183	112	68511	404	68660	90,415
67058	405	68004	416	68184	112	68512	422	68661	223
67059	405	68005	123	68200	422	68513	404	68662	223
67062	405	68006	123	68203	422	68514	422	68663	223
67063	405	68007	160,207	68205	220	68515	392	68664	223
67065	405	68008	211,404	68213	388	68516	422	68665	223
67066	405	68009	210	68215	220	68518	422	68666	223
67069	405	68010	419	68225	220	68520	422	68667	223
67070	405	68017	160,207	68235	220	68522	422	68668	223
67074	405	68021	210	68240	423	68524	422	68669	223
67084	405	68023	386	68246	392	68526	422	68714	419
67090	406	68024	386	68248	416	68536	423	68716	419
67091	406	68026	386	68250	386	68537	423	68718	419
67092	406	68030	416	68252	386	68538	423	68720	160,207
67093	406	68031	416	68253	386	68540	423	68723	417

Ref	Pag	Ref	Pag	Ref	Pag	Ref	Pag	Ref	Pag
68724	417	68944	400	69042	508	69138	328,460	69248	370
68725	419	68945	399	69045	329,468	69139	317	69249	370
68726	416	68946	400	69046	508	69140	162	69250	369
68729	417	68948	400	69047	508	69141	303,523	69251	369
68730	419	68950	399	69048	508	69145	329,468	69256	219,481
68731	416	68952	400	69050	506	69146	162	69259	508
68732	417	68954	399	69051	508	69151	506	69260	339,486
68735	419	68955	399	69052	508	69152	162	69261	303,523
68736	416	68960	399	69053	508	69156	162	69263	332,470
68739	90,415	68964	399	69054	508	69163	338,485	69264	332,470
68740	90,415	68965	399	69055	508	69164	337,484	69266	333,471
68741	90,415	68968	395	69056	508	69165	162	69267	330,472
68750	418	68969	394	69057	508	69166	463	69272	482
68751	418	68970	399	69058	508	69167	463	69273	482
68752	418	68971	399	69059	508	69168	162	69274	482
68753	418	68972	399	69061	332,470	69169	452	69275	482
68754	419	68973	399	69062	485	69170	453	69276	227,478
68808	417	68974	395	69063	443	69171	516	69277	226,477
68810	417	68976	208	69064	485	69172	337,484	69278	482
68814	417	68977	208	69065	337,484	69173	337,484	69279	483
68818	417	68978	208	69066	337,484	69175	516	69280	489
68821	417	68979	208	69068	445	69178	516	69281	483
68822	417	68980	400	69070	517	69179	461	69282	483
68823	417	68981	394	69071	517	69184	516	69283	488
68824	417	68982	394	69072	517	69185	516	69285	488
68825	417	68983	394	69073	443	69186	516	69286	488
68827	417	68984	395	69075	517	69187	516	69287	489
68828	417	68985	400	69078	517	69192	512	69288	490
68829	417	68987	208	69079	449	69193	513	69289	227,478
68831	417	68988	394	69081	500	69194	500	69291	226,477
68832	417	68989	403	69084	431	69195	496	69292	227,478
68833	417	68990	400	69087	316	69196	465	69294	337,484
68835	417	68991	401	69088	317	69197	462	69295	496
68836	417	68992	401	69089	315	69199	453	69296	337,484
68842	417	68993	401	69091	315	69202	370	69297	226,477
68862	417	68994	401	69092	316	69203	370	69298	228,475
68863	417	68995	400	69093	317	69204	370	69300	520
68882	417	68996	401	69094	317	69205	370	69302	513
68890	423	68997	401	69095	316	69207	370	69303	513
68892	401	68998	401	69096	319	69208	371	69304	512
68893	401	68999	401	69097	318,319	69211	371	69310	519
68900	400	69001	320	69098	318	69212	371	69311	455
68901	400	69002	320,474	69099	315	69213	370	69313	519
68904	400	69004	320	69100	318	69214	369	69314	518
68906	400	69006	62,322	69101	319	69215	371	69315	430
68908	400	69012	320,474	69107	62,322	69217	369	69317	403,466
68910	400	69015	320	69108	62,322	69219	514	69318	330,466
68912	400	69018	322	69109	62,322	69221	144	69319	330,466
68914	400	69019	319	69110	320	69222	465	69320	518
68915	400	69020	322	69111	433	69223	451	69321	144
68916	400	69022	325	69115	449	69225	369	69322	457
68918	400	69023	325	69116	502	69226	369	69323	457
68924	400	69024	206	69118	448	69227	462	69324	457
68926	400	69027	322	69120	488	69230	448	69325	456
68928	400	69028	322	69121	451	69232	328,460	69326	456
68930	399	69029	206	69122	465	69234	370	69330	457
68932	400	69030	325	69123	451	69235	369	69332	327,459
68934	400	69032	327,459	69125	448	69236	370	69333	327,459
68935	399	69033	327,459	69130	448	69237	370	69335	428
68936	419	69034	320	69131	315,316,318	69238	515	69336	321,473
68937	399	69036	472	69132	326,458	69240	369	69337	326,458
68938	400	69037	330,472	69133	463	69241	370	69338	495
68939	399	69038	330,472	69134	455	69244	429	69339	495
68940	399	69039	330,472	69135	453	69245	429	69342	456
68942	400	69041	121,221,387	69136	162	69246	429	69349	466

Ref	Pag	Ref	Pag	Ref	Pag	Ref	Pag	Ref	Pag
69350	506	69510	447	69816	435	72324	33	85020	44
69352	502	69512	447	69820	438	72420	33	85022	44
69353	504	69514	447	69824	438	72423	33	85024	44
69354	505	69518	447	69825	438	72424	33	85026	44
69355	507	69520	487	69830	438	72428	33	85028	44
69360	339,486	69521	146	69840	438	72620	33	85032	44
69361	332,470	69523	450	69850	438	72624	33	85118	44
69363	338,485	69530	504	71318	86	72625	33	85120	44
69365	333,471	69531	504	71320	86	72628	33	85122	44
69367	333,471	69540	504	71322	86	72629	33	85124	44
69368	444	69541	504	71324	86	72632	33	85125	44
69369	445	69550	146	71326	86	72714	33	85126	44
69372	491	69551	146	71328	86	72716	33	85128	44
69373	491	69552	146	71710	62	72720	33	85129	44
69379	461	69553	146	71726	86	72803	105	85212	44
69380	500	69554	145	71780	62	72804	105	85214	44
69382	493	69555	146	71815	65	72805	105	85216	44
69384	430	69556	146	71818	86	72806	105	85218	44
69385	202,216,480	69557	146	71820	86	72807	105	85220	44
69386	494	69558	146	71821	65	72808	105	85420	45
69387	495	69562	331,469	71822	86	72809	105	85424	45
69388	431	69563	331,469	71824	86	72810	105	85624	45
69389	492	69564	333,471	71826	86	72811	105	85625	45
69396	218,479	69565	333,471	71828	86	72850	104	85629	45
69397	225,476	69566	333,471	71862	67	72851	104	85712	45
69398	218,479	69574	464	71864	67	72853	104	85714	45
69400	531	69575	489	71866	67	72854	104	85716	45
69401	531	69581	499	71868	67	72855	104	85718	45
69410	528	69583	432	71871	66	72856	104	85916	45
69411	528	69584	432	71872	66	72857	104	85918	45
69414	528	69587	499	71874	66	72858	104	85920	45
69420	529	69590	226,477	71875	66	72859	104	85922	45
69421	529	69591	226,477	71876	66	72916	33	85924	45
69422	529	69683	432	71878	66	72918	33	85926	45
69423	529	69684	432	71884	67	72920	33	85928	45
69424	530	69685	432	71886	67	72924	33	88000	43
69425	530	69722	435	71887	67	72928	33	88016	42
69445	329,468	69723	435	71914	77	72932	33	88018	42
69450	402,467	69735	438	71916	77	79000	35	88020	42
69451	508	69736	438	71918	77	79016	34	88022	42
69452	508	69750	438	71920	77	79020	34	88024	42
69453	508	69751	438	71922	77	79024	34	88026	42
69454	508	69761	436	71924	77	79028	34	88028	42
69455	508	69762	436	71926	77	79116	34	88032	42
69458	508	69763	436	71928	77	79120	34	88116	42
69459	508	69764	436	71931	77	79124	34	88118	42
69460	508	69765	436	71932	77	79128	34	88120	42
69461	508	69771	436	72000	33	79214	35	88121	42
69462	508	69772	436	72016	32	79216	35	88122	42
69463	508	69773	436	72020	32	79218	35	88124	42
69464	508	69774	436	72024	32	79220	35	88125	42
69466	452	69775	436	72028	32	79420	35	88126	42
69468	454	69781	437	72032	32	79424	35	88128	42
69469	454	69782	437	72116	32	79624	35	88129	42
69471	323,474	69783	437	72120	32	79628	35	88132	42
69472	323,474	69784	437	72124	32	79714	35	88212	42
69476	323,474	69785	437	72125	32	79830	35	88214	42
69483	433	69791	437	72128	32	79916	35	88216	42
69485	216,480	69792	437	72129	32	79920	35	88218	42
69488	490	69793	437	72132	32	79924	35	88220	42
69500	446	69794	437	72214	32	79928	35	88318	43
69501	376	69795	437	72216	32	85000	45	88324	43
69503	447	69801	435,438	72218	32	85003	45	88420	43
69505	447	69803	435,438	72220	32	85016	44	88424	43
69507	447	69815	435	72318	33	85018	44	88620	43

Ref	Pag	Ref	Pag	Ref	Pag	Ref	Pag	Ref	Pag
88622	43	91515	375	23432M	71	50650W	96	66110E	178,348
88624	43	91516	375	23540A	89	50660S	22,96	66110H	347
88626	43	91517	375	23550A	89	50660W	96	66110I	178,348
88628	43	91520	373	23620M	72	54020S	18	66110P	346
88632	43	91521	373	23622M	72	54021S	18	66110Z	343
88712	43	91522	374	23624M	72	54024S	18	66115H	347
88714	43	91523	374	23626M	72	54025S	18	66115P	346
88716	43	91525	373	23628M	72	54028S	18	66115Z	343
88718	43	91530	380	23632M	72	54029S	18	66120H	347
88916	43	91533	380	50016S	21	54032S	18	66120P	346
88918	43	91540	374	50017S	22	54033S	18	66120Z	343
88920	43	91541	374	50020S	21	54036S	18	66140Z	343
88922	43	91542	374	50021S	22	54037S	18	66155Z	343
88924	43	98803	110	50024S	21	54040S	18	66165E	178,348
88926	43	98804	110	50025S	22	54041S	18	66165H	347
88928	43	98806	110	50028S	21	54045S	18	66165J	178,348
88932	43	98807	110	50029S	22	54046S	18	66165P	346
90000	39	98808	110	50032S	21	54050S	18	66165Z	343
90016	38	98810	110	50033S	22	54051S	18	66202Z	344
90018	38	98811	110	50036S	21	54119S	19	66210E	178,348
90020	38	98903	109	50037S	22	54120S	19	66210H	347
90022	38	98904	109	50040S	21	54123S	19	66210J	178,348
90024	38	98905	109	50041S	22	54124S	19	66210P	346
90026	38	98906	109	50045S	21	54127S	19	66210Z	344
90028	38	98907	109	50046S	22	54128S	19	66215H	347
90032	38	98908	109	50050S	21	54131S	19	66215P	346
90116	38	98909	109	50051S	22	54132S	19	66215Z	344
90118	38	98910	109	50060S	21	54135S	19	66220H	347
90120	38	98911	109	50061S	22	54136S	19	66220P	346
90122	38	98912	109	50116S	22	54139S	19	66220Z	344
90124	38	98913	109	50119S	22	54140S	19	66240Z	305,344
90125	38	98914	109	50120S	22	54145S	19	66255Z	344
90126	38	99915	532	50123S	22	54150S	19	66265E	178,348
90128	38	99916	532	50124S	22	54225N	20	66265H	347
90129	38	99917	532	50127S	22	54229N	20	66265J	178,348
90132	38	99918	532	50128S	22	54636S	19,96	66265P	346
90212	38	99920	532	50131S	22	54640S	19,96	66265Z	344
90214	38	99921	532	50132S	22	54645S	19,96	66302Z	344
90216	38	99922	532	50135S	22	54650S	19,96	66310E	179,348
90218	38	20540A	28,89	50136S	22	60316P	129	66310H	347
90220	38	20540F	28,89	50139S	22	60316V	129	66310J	179,348
90318	39	20545A	28,89	50140S	22	60318P	129	66310P	346
90324	39	20545F	28,89	50145S	22	60319V	129	66310Z	344
90420	39	20550A	28,89	50150S	22	60320P	129	66315H	347
90424	39	20550F	28,89	50160S	22	60322P	129	66315P	346
90620	39	20555A	28,89	50225N	23	60324P	129	66315Z	344
90622	39	20555F	28,89	50229N	23	61925A	140	66320H	347
90624	39	20560A	28,89	50323S	126	61925R	140	66320P	346
90626	39	20560F	28,89	50327S	126	61940A	140	66320Z	344
90628	39	20565A	28,89	50333S	126	61940R	140	66340Z	344
90632	39	20565F	28,89	50337S	126	61970A	140	66355Z	344
90712	39	20570A	28,89	50341S	126	61970R	140	66365E	179,348
90714	39	20570F	28,89	50624S	22,96	62303I	247	66365H	347
90716	39	21718M	71	50624W	96	62304I	247	66365J	179,348
90718	39	21720M	71	50628S	22,96	62530A	88	66365P	346
90916	39	21722M	71	50628W	96	62535A	88	66365Z	344
90918	39	21724M	71	50632S	22,96	62540A	88	66402Z	344
90920	39	21726M	71	50632W	96	62545A	88	66410E	179,349
90922	39	21728M	71	50636S	22,96	66002Z	343	66410H	347
90924	39	21732M	71	50636W	96	66010Z	343	66410J	179,349
90926	39	23420M	71	50640S	22,96	66015Z	343	66410P	346
90928	39	23422M	71	50640W	96	66020Z	343	66410Z	344
90932	39	23424M	71	50645S	22,96	66040Z	343	66415H	347
91505	375	23426M	71	50645W	96	66065Z	343	66415P	346
91511	375	23428M	71	50650S	22,96	66102Z	343	66415Z	344

Ref	Pag	Ref	Pag	Ref	Pag
66420Z	344	66911H	347	R61679B	441
66465E	179,349	66911P	346	R61682A	440
66465H	347	66911Z	345	R61682B	440
66465J	179,349	66912H	347	R63033	251
66465P	346	66912P	346	R63053A	251
66465Z	344	66912Z	345	R67000	142,396
66502Z	344	66913H	347	R67001	142,396
66510Z	344	66913P	346	R67002	142,396
66515Z	344	66914H	347	R67003	142,396
66520Z	344	66914P	346	R67004	142,396
66540Z	305,310,344	66916H	347	R67005	142,396
66565E	179,349	66916P	346	R67006	142,396
66565J	179,349	66923Z	345	R67150B	143,397
66565Z	344	66925Z	345	R69018	322,322,322
66610E	179,349	66933C	354	R69027	322
66610H	347	66934C	354	R69061A	332,470
66610J	179,349	66936C	354	R69094A	317
66610P	346	66936T	354	R69099B	315,316
66610Z	345	66937C	354	R69099C	315,316,317
66615H	347	66945S	355	R69100A	318
66615P	346	66945T	355	R69100B	318,319
66615Z	345	66948S	354	R69195N	497
66620Z	345	66949S	354	R69245B	429
66665E	179,349	66949T	354	R69295A	497
66665H	347	66957S	355	R69295B	497
66665J	179,349	66965H	347	R69382F	233,493
66665P	346	66965Z	345	R69400B	531
66665Z	345	66972C	355	R69400N	531
66765E	179,349	66974C	355	R69400R	531
66765J	179,349	67604Z	344	R69561A	427
66901D	345	67610Z	344	R69561B	427
66901DH	347	67615Z	344	R69561C	427
66901DZ	345	67665Z	344	R69561D	427
66901P	346	67901Z	345	R69561E	427
66901Z	345	67902Z	345	R69561F	427
66902D	345	67903Z	345	R69561N	427
66902DH	347	67904Z	345	R69561P	427
66902DZ	345	67905Z	345	R69561Q	427
66902P	346	67906Z	345	R69561S	427
66902Z	345	67909Z	345	R69561T	427
66903D	345	69400F	531	R69561V	427
66903DH	347	69400P	531	R69561W	427
66903DZ	345	69401F	531	R69561Z	427
66903P	346	69401P	531	R69722J	435
66903Z	345	69561E	426	R69735J	438
66904D	345	69561F	426	R71710	62
66904DH	347	69561I	426	R71711	62
66904DZ	345	R25436A	79,93,97	R71723	62
66904P	346	R25536A	79,94	R91533A	380
66904Z	345	R25547A	79,94	Recipientecristal	205
66905D	345	R25736A	79,94		
66905DZ	345	R25747A	79,94		
66905Z	345	R25917G	57,93		
66906D	345	R25921G	57,93		
66906DH	347	R25933G	57,93		
66906DZ	345	R25935G	57,93		
66906P	346	R27520A	51,94		
66907P	256	R27528A	51,94		
66909D	345	R27732A	51,94		
66909DH	347	R39042A	214		
66909DZ	345	R39135C	524		
66909P	346	R60594A	305		
66910H	347	R61671A	442		
66910P	346	R61671F	442		
66910Z	345	R61679A	441		



Índice alfabético



Sommaire alphabétique



Alphabetisch Index



Alphabetical Index



Índice alfabético

A

ABLANDACARNE 133
 ABRE OSTRAS 214, 281
 ABREBOTELLAS 249
 ABRELÁTAS 281, 303
 ABRIDOR HUEVOS 123
 ACEITERA 200, 201
 AERÓGRAFO 402, 467
 AFILADOR CUCHILLOS 302, 303, 523
 AGUJA DE MECHAR 132
 AHUMADOR 144, 146
 AIR POT 232, 323, 474
 AIRPOT 323, 474
 ANILLA ANTI-GOTEO 251
 ARMARIO ESTERILIZADOR 523
 ARMARIO REFRIGERADOR 515, 516, 517
 ARO 416, 422
 ARO PERFORADO 423
 ASA DE SILICONA 51, 94
 ASADOR 75
 ATRILPORTA MENÚ 214, 253
 AZUCARERO 206, 222

B

BANDEJA 355
 BANDEJA / FUENTE 158, 159, 160, 161, 164, 165, 166, 167, 168, 169, 170, 172, 173, 174, 175, 176, 207
 BANDEJA CAMARERO 159, 162, 171
 BANDEJA HÖRNÖ 28
 BANDEJA ISOTÉRMICA 354
 BAÑO MARIA 23, 25, 403, 466, 472
 BARRA SUJECCIÓN NOTAS 113
 BÁSCULA 149, 150, 151, 152, 385, 522
 BATERÍA 8 PIEZAS 33, 35, 37, 39, 41, 43, 45
 BATIDOR 106, 109, 119, 120, 121, 221, 387, 391
 BATIDORA 40, 41, 42, 43, 45, 46, 47, 48, 49, 40, 41, 42, 43, 44, 45, 46, 47, 48, 50
 BIBERÓN DECORACIÓN 140, 403
 BOBINA FILM 377
 BOBINA VACÍO 508
 BOL 126, 165, 167, 170, 171, 172, 173, 174, 205, 354, 355, 384
 BÓLAS AISLANTES SOUS VIDE 514
 BOLSAS VACÍO 508
 BOMBA VACÍO 251
 BOQUILLA SERVIDORA 251
 BOQUILLAS 400, 401
 BOTELLA BIBERÓN 140, 403
 BOTELLA DOSIFICADORA 249
 BOTELLA PERSONAL 233
 BOTELLA PREPARACIÓN ALIÑO 201
 BOTELLERO 235, 245
 BOTES VACÍO 508

A

CACEROLA 18, 21, 24, 26, 31, 32, 33, 36, 38, 40, 44, 46, 48, 49, 51, 53, 55, 57, 58, 59, 60, 189, 190, 191, 192
 CACEROLA ALTA 18, 22, 24, 26
 CACEROLA BAJA 49, 55
 CACEROLA OVAL 57, 58, 59, 60, 189, 190, 191, 192
 CACEROLA VAPOR 21, 33, 35, 37, 39, 41, 43, 45, 127
 CACILLO 102, 104, 105, 106, 107, 108, 109, 110, 171
 CACILLO PERFORADO 102, 171
 CACILLO SALSA 104, 105, 106, 109, 110
 CADENA 416
 CAFETERA 219, 220, 221, 222, 481
 CAFETERA GOTEO 482, 483
 CALDERO 126
 CALENTADOR 329, 330, 331, 468, 469, 472, 528, 529, 530, 531
 CALENTADOR CHAFING 320, 474
 CALENTADOR LÍQUIDOS 322
 CAMINO DE MESA 183
 CAMPANA AHUMADOR 145
 CAMPANILLA 206
 CARRO SERVICIO 352, 353, 355
 CASCANUECES 214
 CAZO BOMBADO 27

CAZO CÓNICO 20, 23
 CAZO FRANCÉS 20, 23
 CAZO RECTO 19, 23, 25, 27, 31, 32, 35, 36, 38, 40, 41, 42, 44, 45, 46, 48, 51, 53, 55, 75, 108
 CAZO RECTO ALTO 19, 23, 25, 27
 CEDAZO 386
 CENICERO 208, 381
 CENTRIFUGADORA 147
 CEPILLO PARA TABLA CORTE 310
 CEPILLO RECOGEDOR 207, 379
 CESTA 369, 370, 371
 CESTILLO 195, 196
 CHAFING DISH 315, 316, 317, 318, 319, 320, 321, 473
 CHAIRA 297, 299
 CIERRE PORTAFICHAS 354
 COCEDOR AL VAPOR 451
 COCTELERA 247
 COLADOR 28, 33, 37, 39, 41, 43, 103, 129, 130, 248
 COLGADOR 113
 CONTENEDOR ALIMENTOS 139
 CONTENEDOR CUBIERTOS 113
 COOKINGME 426, 427
 COPA 405
 COPAS/VASOS 242, 243
 CORDEL COCINA 91
 CORDÓN DE CUERO 261
 CORTA VEGETALES 446, 447, 449
 CORTADOR 132, 280, 281, 283, 284, 285, 286, 287, 448
 CORTADORA FIAMBRE 448
 CORTAPASTAS 392
 CORTAPIZZA 117, 287
 CREPERA 73, 76, 79, 80, 86, 465
 CUBETA 178, 179, 342, 343, 344, 345, 346, 347, 348, 349
 CUBETA PERFORADA 343, 344
 CUBIERTOS 311
 CUBITERA 238, 247
 CUBO 126
 CUBO ENFRIABOTELLAS 236, 237, 238, 239, 240
 CUBRE QUESO/TARTA 206
 CUBREPLATOS 206, 355
 CUCHARA APOYA UTENSILIOS 103
 CUCHARA LISA 102, 104, 105, 106, 107, 108, 109, 110, 111, 112, 119, 171, 174, 391
 CUCHARA MIEL 213
 CUCHARA OBLICUA 102
 CUCHARA PERFORADA 102, 104, 105, 106, 109, 110, 111, 171
 CUCHARILLA COCKTAIL 249
 CÚCHILLO 280, 281, 282, 295, 296, 297, 298, 299
 CUECE ESPECIAS 127
 CUECEPASTAS 33, 37
 CUSCUSERA 127

D

DELANTAL 378
 DESCÁPULADOR 251
 DESCORAZONADOR 281, 282, 286
 DESESCAMADOR DE PESCADO 214
 DESHIDRATADOR 450, 451
 DESHOJADOR DE HIERVAS 132, 285
 DISPENSADOR 204, 324, 325, 377
 DISPENSADOR JABÓN 373, 374
 DISPENSADOR REPOSTERÍA 143, 397
 DOBLE FONDO 345, 346, 347
 DOSIFICADOR 142, 143, 396, 397
 DOSIFICADOR LICOR 248

E

EMBUDO 130, 251
 EMBUTIDORA MANUAL 138
 EMPUJADOR 423
 ENCENDEDOR 208
 ENSALADERA 205
 ESCURREFRITOS 128
 ESCURRIDERA 33, 37, 39, 41, 43, 128
 ESPÁTULA 108, 116, 119, 390, 391

ESPÁTULA LISA	102, 105, 106, 107, 109, 111, 115, 116, 117, 119, 281, 390, 391	
ESPÁTULA PERFORADA	102, 104, 105, 109, 110, 111	
ESPÁTULA PIZZA	117	
ESPECIERO	203, 204	
ESPUMADERA	102, 103, 104, 105, 106, 107, 108, 109, 110	
ESPUMADOR DE LECHE	218, 479	
ESTANTE TUBULAR	353	
ESTANTERÍA	358, 359, 360, 361, 362, 363, 364, 365, 366	
ESTECAS	389	
EXPRIMIDOR	136, 487, 488, 489, 491	
F		
FLANERO	414, 416, 417	
FONDUE	62	
FREIDORA	452, 453, 454, 455	
FRUTEROS	186, 187, 334, 335	
FUENTE CHOCOLATE	330, 486	
FUENTE HONDA	126, 384	
FUENTE PARA MANTEQUILLA	206	
FUNDA	233, 493	
FUNDA CARRÓ	352	
FUNDA ENFRIABOTELLAS	235	
G		
GANCHOS	113, 298	
GEL COMBUSTIBLE	62, 322	
GEL HIDROALCOHÓLICO	375	
GOFRERA	466	
GRILL	51, 55, 79, 80, 81, 82	
GUANTE	92, 93, 294	
GUÍA DIVIDORA	345	
H		
HARINERO	128	
HERVIDOR	127	
HERVIDOR AGUA	224, 225, 226, 227, 228, 475, 476, 477, 478	
HERVIDOR PESCADO	28	
HIGIENIZANTE	375	
HORNO	456	
I		
INDICADOR RESERVADO	206	
J		
JAMONERO	310	
JARRA DE AGUA	124, 241, 355	
JARRA SEPARADOR GRASA	201	
JARRA TERMO	230, 231	
JUEGO DE CÚCINA	106	
JUEGO SALERO-PIMENTERO	199, 200	
JUEGO VINAGRERAS	199, 200	
L		
LÁMINA	91, 414, 450	
LAMINADOR	137, 283, 287	
LÁMPARA CALENTAMIENTO	330, 332, 333, 470, 471, 472	
LECHERA	217, 222	
LEGUNBRERA	205	
LIBRADOR	247, 385	
LICUADORA	490	
M		
MACHETE	297	
MALETA CUCHILLOS	298	
MANDOLINA	290, 291	
MANGA REPOSTERÍA	399	
MANO CHINO	129	
MANO MORTERO	135	
MANOPLA	57, 79, 93, 94	
MANTEL INDIVIDUAL	181, 182, 183, 184	
MÁQUINA CUBITOS HIELO	518	
MÁQUINA DE HELADO	430	
MÁQUINA ENFRIACOPAS	520	
MÁQUINA VACÍO	502, 504, 505, 506, 507	
MARCADOR TARTA	404	
MARTILLO	133	
MATAMOSQUITOS	524, 525, 526	
MAZA	248	
MEDIDOR	125, 384, 385	
MEDIDOR PASTA	137	
MICROONDAS	456, 457	
MINI-GRILL	59, 61, 191, 193	
MINI-CUBO	195	
MOLDE BAGUETTE	415	
MOLDE EMPANADILLAS	133	
MOLDE HUEVO	123	
MOLDE PIZZA	417	
MOLDE REPOSTERÍA	408, 409, 410, 411, 412, 413, 414, 416, 417, 418, 419, 423	
MOLDES BOMBÓN	421	
MOLINILLO	202, 203, 204, 216, 217, 480	
MORTERO	135	
N		
NIDOS ALAMBRE	103	
NÚMEROS MESA	205, 206	
O		
OLLA	19, 22, 25, 27, 30, 32, 34, 36, 38, 40, 42, 44, 48, 53, 379, 461	
OLLA A PRESIÓN	64, 65, 66, 67	
OLLA BAJA	19, 22	
OLLA ELÉCTRICA	428	
OLLA SUPER ALTA	32, 36, 38, 40, 42, 44	
ORGANIZADOR ACCESORIOS CÓCTEL	246	
ORGANIZADOR DE CAFÉ	325	
P		
PAELLERA	19, 22, 25, 27, 61, 75, 79, 96, 97, 98, 99, 196	
PAJITAS	495	
PALA	117	
PALA ENSALADA	104	
PALA PASTEL	104, 281	
PALA PESCADO	102, 108, 109	
PALA PIZZA	117	
PALILLERO	199	
PANERA	187, 188, 335, 336	
PAPELERA	207, 376, 379	
PARRILLA	90, 345, 415	
PASAPURÉS	131, 133	
PEINE CARNE	287	
PEINE DECORACIÓN	389	
PELADOR	280, 281, 282, 283	
PICADORA	134, 443	
PICADORA CARNE	443, 444, 445	
PICADORA HIELO	247, 519	
PIE PORTACUBOS	236	
PINCEL	119, 122, 391	
PINCHO MARISCO	214	
PINCHO MARINO	113	
PINZA	90, 171, 210, 211, 212, 213, 214, 247, 345, 404	
PINZAS	90, 211, 213, 224, 345	
PIPETA PARA SALSA	139	
PISTOLA GAS	394, 395	
PISTOLA REPOSTERÍA	403	
PIZARRA	251, 254, 255, 521	
PLACA CALENTAMIENTO	320, 329, 468, 474, 483	
PLACA HORNO	90, 415	
PLACA INDUCCIÓN	315, 316, 317, 318, 326, 327, 328, 458, 459, 460	
PLACA VITROCERÁMICA	328, 460	
PLANCHA GRILL	76, 79, 461	
PLANCHA GRILL	462, 463, 464	
PLATO	165, 167, 175, 354, 355	
PLATO CAMPING	160	
PLATO DE HUEVOS	160	
PORTA COMANDAS	264, 266	
PORTA FACTURAS	264, 266	
PORTA MENÚ	255, 261, 262, 263, 264, 265, 266, 267, 268, 269, 270, 271, 272, 273, 274, 275, 276, 277	

PORTARROLLOS	378	TENEDOR	102, 103, 104, 105, 106, 107, 111, 112, 295, 297
PORTATAARTA	169, 404	TERMO	232
POSABOTELLAS	160	TERMOMETRO	112, 153, 154, 155
POSAVASOS	162	TERMOTRANS	351
POSAVASOS	160	TETERA	222, 223
POSTE SEPARADOR	380	TIJERAS	300
POTE CILINDRICO	27, 33, 35, 37, 39, 41, 43, 45	TOSTADORA	337, 338, 339, 484, 485, 486
PRENSA AJÓS	281	TRIANGULO	130
PULVERIZADOR	201		
		V	
Q		VASO	355
QUEMADOR	395, 467	VASOS CUBERTERIA	243, 311
QUESERA	205	VITRINA EXPOSITORA	256
R		W	
RACIONADOR HELADO	405, 406	WOK	35, 47, 73, 76, 78, 80, 85, 328, 460
RALLADOR	134, 287, 288, 289		
RASERA	103	Y	
RASQUETA	118, 389	YOGURTERA	429
REFRIGERADOR	517		
REJILLA PARA SOUS VIDE	514		
REJILLA REPOSTERIA	404		
RELOJ COCINA	94, 155		
RIBETeadOR DE COPAS Y VASOS	246		
ROBOT MULTIFUNCIÓN	449		
RODILLO	388		
ROTULADORES PIZARRA	255, 521		
RUSTIDERA	23, 28, 88, 89		
S			
SACACORCHOS	250, 251		
SALAMANDRA	462		
SALSERÁ	205		
SALVAMANTELES	185		
SARTÉN	31, 37, 45, 47, 51, 53, 55, 69, 70, 71, 72, 73, 74, 75, 78, 80, 81, 82, 83, 84, 85, 86		
SAUTEX	20, 23, 25, 33, 45, 47		
SECADOR MANOS	376		
SELLOS PARA GALLETAS	393		
SEPARADOR CLARAS	123		
SERRÍN MADERA	146		
SERVIDOR ESPAGUETIS	105, 106, 108, 109, 110		
SERVIDOR ZUMOS	322		
SERVILLETERO	182, 207, 378		
SET REPOSTERIA	119, 391		
SIERRA SUECA	392		
SIFÓN	141, 398		
SIFÓN AGUA	248		
SÓPERA	205		
SÓPORTE BATIDORA BRISK	435, 438		
SÓPORTE CALDERO	126		
SÓPORTE COPAS	244, 245		
SÓPORTE CUBIERTOS	311		
SÓPORTE MAGNÉTICO	301		
SÓPORTE MENU	206		
SÓPORTE MESA ENFRIABOTELLAS	236		
SÓPORTE PAELLERA	99		
SÓPORTE PAELLERA GAS BUTANO	99		
SÓPORTE PARA HUEVO	123		
SÓPORTE PARA ROLLO	504		
SOUS VIDE	512, 513		
SUJETA MANTELES	206		
T			
TABLA DE CORTE	304, 305, 306, 307, 308, 309, 310		
TABLA SERVIR	177, 194, 197, 198		
TACÓ CUCHILLO	297, 298		
TAPA	20, 23, 25, 28, 31, 33, 35, 37, 39, 41, 43, 45, 47, 51, 53, 55, 64, 77, 89		
TAPA PARA CUBETA	345, 346, 347		
TAPETE	91, 414		
TAPÓN	251		
TARTERA	31, 33, 35, 37, 39, 41, 43, 51, 53		
TAZA	354		
TENAZA MARISCO	213, 214		

A			
AÉROGRAPHE		402, 467	
AFÛTEUSE DE COUTEAUX		302, 303, 523	
AIGUILLE À LARDER		132	
AIR POT		292, 323, 474	
AIRPOT		323, 474	
ALLUME-GAZ		208	
ANNEAU STOP GOUTTLES À VIN		251	
APPAREIL ANTI-MOUSTIQUES		524, 525, 526	
ARAIGNEE		103	
ARDOISE		251, 254, 255, 521	
ARMOIRE À STÉRILISER		523	
ASSIETTE		165, 167, 175, 354, 355	
ATTENDRISEUR À VIANDE		133	
B			
BAC		178, 179, 342, 343, 344, 345, 346, 347, 348, 349	
BAC PERFORÉ		343, 344	
BAHUT		23, 25, 403, 466, 472	
BAIN MARIE		315, 316, 317, 318, 319, 320, 321, 473	
BALANCE		149, 150, 151, 152, 385, 522	
BARRE À NOTES		113	
BASSINE		126	
BASSINE PÂTISSIERE		126, 384	
BATTERIE 8 PCS		33, 35, 37, 39, 41, 43, 45	
BATTEUR		43, 45, 42, 43, 45, 45, 47, 48, 49, 40, 41, 42, 42, 43, 44, 45, 46, 47, 48, 50	
BÈC VERSEUR		251	
BEURRIER AVEC COUVERCLE		206	
BIBERON À DÉCORER		140, 403	
BILLES ISOLANTES SOUS VIDE		514	
BLOC COUPEAU		297, 298	
BOBINE DE CONSERVATION		508	
BOÎTE À CONDIMENT		139	
BOÎTE À FROMAGE		205	
BOÎTES DE CONSERVATION		508	
BÔL		126, 165, 167, 170, 171, 172, 173, 174, 205, 354, 355, 384	
BOUCHON		251	
BOUILLÔRE		224, 225, 226, 227, 228, 475, 476, 477, 478	
BOUEILLE BIBERON		140, 403	
BOUEILLE DOSEUSE		249	
BRAISIÈRE		18, 22, 24, 26	
BROCHETTE		113	
BROSSE POUR PLANCHE		310	
BROYEUR À GLAÇONS		247, 519	
C			
CAFETIÈRE		219, 220, 221, 222, 481	
CAFETIÈRE FILTRE		482, 483	
CASIER		369, 370, 371	
CASSE NOIX		214	
CASSEROLE		19, 23, 25, 27, 31, 32, 35, 36, 38, 40, 41, 42, 44, 45, 45, 48, 51, 53, 55, 75, 108	
CASSEROLE BOMBÉE		27	
CASSEROLE FRANÇAISE		20, 23	
CASSEROLE HAUTE		19, 23, 25, 27	
CASSIER À VIN		235, 245	
CENDRIER		208, 391	
CERCLE		416, 422	
CERCLE PERFORÉ		423	
CHAÎRE		416	
CHARIOT DE SERVICE		352, 353, 355	
CHAUFFE		329, 330, 331, 468, 469, 472, 528, 529, 530, 531	
CHAUFFE-CAFÉ		322	
CHAUFFE-CHAFING		320, 474	
CHEMIN DE TABLE		183	
CISEAUX		300	
CLOCHE À FUMER		145	
CLOCHE		206, 355	
COCOTTE À PRESSION		64, 65, 66, 67	
COCOTTE ÉLECTRIQUE		428	
COOKINGME		426, 427	
CORBILLE À FRUITS		186, 187, 334, 335	
CORDON EN CUIR		261	
COUPE		405	
COUPE CAPSULE		251	
COUPE PÂTE		118, 389	
COUPELLE		354	
COUPER		132, 280, 281, 283, 284, 285, 286, 287, 448	
COUPERET		297	
COUSCOUSSIER		127	
COUPEAU		280, 281, 282, 295, 296, 297, 298, 299	
COUPEAU À HUÎTRES		214, 281	
COUVERCLE		20, 23, 25, 28, 31, 33, 35, 37, 39, 41, 43, 45, 47, 51, 53, 55, 64, 77, 89	
COUVERCLE POUR BAC		345, 346, 347	
COUVERT		311	
COUVRE FROMAGE/GÂTEAU		206	
CREMIÈRE		217, 222	
CREPIÈRE		73, 76, 79, 80, 86, 465	
CROCHETS		113, 298	
CUILLÈRE À GLACE		405, 406	
CUILLÈRE À MIEL		213	
CUILLÈRE À SPAGUETIS		105, 106, 108, 109, 110	
CUILLÈRE COCKTAIL		249	
CUILLÈRE OBLIQUE		102	
CUILLÈRE RAMASSE USTENSILES		103	
CUILLÈRE LISSE		102, 104, 105, 106, 107, 108, 109, 110, 111, 112, 119, 171, 174, 391	
CUILLÈRE PERFORÉE		102, 104, 105, 106, 109, 110, 111, 171	
CUISEUR VAPEUR		451	
CUIT-PÂTE		33, 37	
CURETTES À HOMARD		214	
D			
DÉCAPSULEUR		249	
DECOUPOIRS DIVERS		392	
DÉROULEUR		378	
DESHYDRATEUR		450, 451	
DÉSINFECTANT		375	
DESSOUS DE PLATS		185	
DESSOUS DE VERRE		182	
DIFFUSEUR ÉPICES		127	
DISTRIBUTEUR		204, 324, 325, 377	
DISTRIBUTEUR		322	
DISTRIBUTEUR À SAVON		373, 374	
DISTRIBUTEUR DE PÂTISSIERE		143, 397	
DISTRIBUTEUR DE SERVIETTES		182, 207, 378	
DOUBLE FOND		345, 346, 347	
DOUILLES		400, 401	
E			
ECUMOIRE		102, 103, 104, 105, 106, 107, 108, 109, 110	
EFFEUILLEUSE À HERBES		132, 285	
ENTONNOIR		130, 251	
ENTONNOIR À DÉCOR		142, 143, 396, 397	
ÉPLUCHE		280, 281, 282, 283	
ÉPLUCHEUSE		137, 283, 287	
ESSOREUSE		147	
ÉTAGÈRE TUBULAIRE		353	
EXPOSANT PÂTISSIERE		119, 391	
F			
FAITOUT		16, 21, 25, 31, 32, 34, 36, 38, 40, 42, 44, 45, 48, 49, 51, 53, 55, 57, 58, 59, 60, 189, 190, 191, 192	
FAITOUT BASSE		49, 55	
FAITOUT OVALE		57, 58, 59, 60, 189, 190, 191, 192	
FER À CARAMELISER		395, 467	
FEUILLES		91, 414, 450	
FIL DE CUISINE		91	
FONDUE		62	
FONTAINE CHOCOLAT		330, 466	
FOUET		106, 109, 119, 120, 121, 221, 387, 391	
FOUR		456	
FOURCHETTE		102, 103, 104, 105, 106, 107, 111, 112, 295, 297	
FRITEUSE		452, 453, 454, 455	
FRUIT CENTRIFUGEUSE		490	
FUMOIR		144, 146	
FUSIL		297, 299	

G	
GANT	92, 93, 294
GAUFRIER	466
GEL CHAUFFE	62, 322
GEL HYDROALCOOLIQUE	375
GRATTOIR	214
GRILL	51, 55, 79, 80, 81, 82
GRILL	462, 463, 464
GRILLE	90, 345, 415
GRILLE PÂTISSERIE	404
GRILLE-PAIN	337, 338, 339, 484, 485, 486
GUIDE DE DIVISION	345
GURIDON PÂTISIER	169, 404
H	
HACHOIR	134, 443
HACHOIR	134, 287, 288, 289
HACHOIR LÉGUMES	446, 447, 449
HACHOIR POUR VIANDE	443, 444, 445
HOUSSE CHARIOT	352
HOUSSE REFROIDISSEMENT	235
HUILIER	200, 201
I	
INDICATEUR RÉSERVÉE	206
L	
LAMPE DE CHAUFFAGE	330, 332, 333, 470, 471, 472
LEGUMIERE	205
LOUCHE	102, 104, 105, 106, 107, 108, 109, 110, 171
LOUCHE PERFORÉE	102, 171
LOUCHE SAUCE	104, 105, 106, 109, 110
M	
MACHINE À GIVRER LES VERRES	520
MACHINE À GLASÇONS	518
MACHINE DE CRÈME GLACÉE	430
MACHINE SOUS VIDE	502, 504, 505, 506, 507
MANCHE EN SILICONE	51, 94
MANCHON	233, 493
MANDOLINE	290, 291
MARMITE, 22, 25, 27, 30, 32, 34, 36, 38, 40, 42, 44, 48, 53, 379, 461	
MARMITE BASSE	19, 22
MARMITE S. HAUTE	32, 36, 38, 40, 42, 44
MARQUEUR À GÂTEAUX	404
MARQUEURS TABLEAU	255, 521
MARTEAU	133
MÉLANGEUR	201
MELLETE DE CHEF	298
MESURE À COCKTAIL	248
MESUREUR POUR PÂTES	137
MESUREUR	125, 384, 385
MICRO-ONDES	456, 457
MINI GRILL	59, 61, 191, 193
MINI-CUBE	195
MINUTEUR DE CUISINE	94, 155
MORTIER	135
MOUFLETTE	57, 79, 93, 94
MOULE À BAGUETTE	415
MOULE À CHAUSSONS	133
MOULE À FLAN	414, 416, 417
MOULE À OEUF	123
MOULE À PÂTISSERIE, 408, 409, 410, 411, 412, 413, 414, 416, 417, 418, 419, 423	
MOULE À PIZZA	417
MOULE POUR CHOCOLATS	421
MOULIN	202, 203, 204, 216, 217, 480
MOUSSEUR À LAIT	218, 479
N	
NAPPE INDIVIDUEL	181, 182, 183, 184
NUMÉROS DE TABLE	205, 206
O	
OEUFS OUVRER	123
ORGANISATEUR DE CAFÉ	325
ORGANISATEUR POUR ACCESSOIRES DE COCKTAIL	246
OUTILS	389
OUVRE-BOÎTE	281, 303
P	
PAILLES	495
PALETTE À GÂTEAU	104, 281
PANIER	195, 196
PANIER À COUVERTS	113
PANIER À NID	103
PANIER MARGUERITE	127
PANIER POUR COUVERT	243, 311
PANIER VAPEUR	21, 33, 35, 37, 39, 41, 43, 45, 127
PANIERE	187, 188, 335, 336
PASSOIRE	28, 33, 37, 39, 41, 43, 103, 129, 130, 248
PASSOIRE A FRIURE	128
PASSOIRE SUR PIED	33, 37, 39, 41, 43, 128
PAT À OEUFS	160
PEIGNE À PÂTE	389
PEIGNE POUR VIANDE	287
PELLE	117
PELLE À FARINE	247, 385
PELLE À POISSON	102, 108, 109
PELLE À SALADE	104
PELLE PIZZA	117
PENDERIE MURATE	113
PERSONNELLE BOUTEILLE	233
PICHET THERMO	230, 231
PIED POUR RECHAUD	99
PILON	248
PINCE À CASSE-HOMARD	213, 214
PINCE À NAPPE	206
PINCEAU	119, 122, 391
PINCEAU	90, 171, 210, 211, 212, 213, 214, 224, 247, 345, 404
PISTOLET POUR PÂTISSERIE	403
PLANCHE À DÉCOUPER	304, 305, 306, 307, 308, 309, 310
PLAQUE À FOUR	28
PLAQUE À FOUR	90, 415
PLAQUE À GRILL	76, 79, 461
PLAQUE À INDUCTIION, 316, 317, 318, 326, 327, 328, 458, 459, 460	
PLAQUE POUR CHAUFFANTE	320, 329, 468, 474, 483
PLAQUE VITROCÉRAMIQUE	326, 460
PLAT À ROTIR	23, 28, 88, 89
PLAT E DE CAMPING	160
PLAT ROND	19, 22, 25, 27, 61, 75, 79, 96, 97, 98, 99, 198
PLAT ROND	31, 33, 35, 37, 39, 41, 43, 51, 53
PLATEAU	355
PLATEAU, 158, 159, 160, 161, 164, 165, 166, 167, 168, 169, 170, 172, 173, 174, 175, 176, 207	
PLATEAU ISOTHERME	354
PLATEAU LIMONADIER	159, 162, 171
POCHE À DÉCORER	399
PO-CILINDRIQUE	27, 33, 35, 37, 39, 41, 43, 45
POÉLE, 37, 45, 47, 51, 53, 55, 69, 70, 71, 72, 73, 74, 75, 78, 80, 81, 82, 83, 84, 85, 86	
POIRE À JUS	139
POISSONNIÈRE AVEC GRILLE	28
POMPE À VINE	251
PORTE COUVERTS	311
PORTE CURE DENTS	199
PORTE FICHE	354
PORTE-COMMANDES	264, 266
PORTE-FACTURES	264, 266
PORTE-MENU, 255, 261, 262, 263, 264, 265, 266, 267, 268, 269, 270, 271, 272, 273, 274, 275, 276, 277	
PORTE-ROULEAU	504
PORTE-SEAU	236
POT À EAU	124, 241, 355
PÔTEAU SÉPARATEUR	380
POUBELLE	207, 376, 379
POUSSOIR	423
POUSSOIR À CHINOIS	129
POUSSOIR À MORTIER	135

FR Index alphabétique

POUSOIR MANUEL	138	TIRE-BOUCHON	250, 251
PRESSE-AGRUMES	136, 487, 488, 489, 491	TORCHE À CARAMÉLISER	394, 395
PRESSE-PAIL	281	TRANCHEUSE DE CHARCUTERIE	448
PRESSE-PURÉE	131, 133	TRIANGLE	130
PULVÉRISATEUR	201		
PUPITRE PORTE-MENU	214, 253		
R		U	
RACK POUR SOUS VIDE	514	USTENSILES DE CUISINE	106
RAMASSE-MIETTES	207, 379		
RAYONNAGE	368, 359, 360, 361, 362, 363, 364, 365, 366	V	
RECHAUD	99	VERRE	355
REFROIDISSEUR	517	VERRES	242, 243
REFROIDISSEUR À VIN	515, 516, 517	VIDÉ-POMMES	281, 282, 288
ROBOT MULTIFONCTIONS	449	VITRINI DE PRÉSENTATION	256
RÔTISSOIRE	75		
ROULEAU FILM	377	W	
ROULEAU PATISSIER	388	WOK	35, 47, 73, 76, 78, 80, 85, 328, 460
ROULETTE PIZZA	117, 287	Y	
		YAOURTIÈRE	429
S			
SACS DE CONSERVATION	508		
SALADIER	205		
SALAMANDRE	462		
SAUCIERE	205		
SAUPOUDREUSE	203, 204		
SAUTASE CONIQUE	20, 23		
SAUTEUSE	20, 23, 25, 33, 45, 47		
SCIE À GÂTEAUX	392		
SDESSOUS DE BOUTEILLE	160		
SEAU	126		
SEAU À GLACE	236, 247		
SEAU À VIN	236, 237, 238, 239, 240		
SÈCHE-MAINS	376		
SÉPARATEUR À OEUFS	123		
SÉPARATEUR DE GRAISSE	201		
SET CALIÈRE ET POVIÈRE	199, 200		
SET VINAIGRIÈRE	199, 200		
SHAKER	247		
SIPHON	141, 398		
SIPHON À EAU	248		
SOIRE DE BOIS	146		
SONNETTE	206		
SOUPIÈRE	205		
SOUS VIDE	512, 513		
SOUS-VERRE	160		
SPATULA	106, 116, 119, 390, 391		
SPATULE LISSE	102, 105, 106, 107, 109, 111, 115, 116, 117, 119, 281, 390, 391		
SPATULE PERFORÉE	102, 104, 105, 109, 110, 111		
SPATULE PIZZA	117		
SUCREUR/SALEUR BORDEUR DE VERRES	246		
SUCRIER	206, 222		
SUPPORT À COUPES	244, 245		
SUPPORT CUL DE POULE	126		
SUPPORT D'OEUFS	123		
SUPPORT MAGNETIQUE	301		
SUPPORT MÉLANGEUR BRISK	435, 438		
SUPPORT MENU	206		
SUPPORT POUR JAMBON	310		
SUPPORT SEAU	236		
T			
TABLE DE SERVICE	177, 194, 198		
TABLE DE SERVICE	197		
TABLIER	378		
TAMIS	386		
TAMIS À FARINE	128		
TAMPONS POUR BISCUITS	393		
TAPIS	91, 414		
THÉIÈRE	222, 223		
THERMO	232		
THERMOMETRE	112, 153, 154, 155		
THERMOTRANS	351		

DE Alphabetisch Index

A	
ABTRÖPFSCHÜSSEL	33, 37, 39, 41, 43, 128
ABTRÖPFSCHÜSSEL FÜR FRITTIERTES	128
ADBECKUNG FÜR TELLERWAGEN	352
AIRBRUSH	402, 467
ANDRÜCKER	423
APFELENTKERNER	281, 282, 296
APPARAT ZUM RAUCHRN	144, 146
ASCHENBECHER	208, 381
AUSFSCHNITTMASCHINE	448
AUSGIESS-AUFSATZ	251
AUSSTELLENDKASTEN, PASTRY	119, 391
AUSTERMESSER	214, 281
B	
BACKBLECH	90, 415
BACKBLECH-AUFLAGE	91, 414
BACKSCHAUFEL	102, 105, 106, 107, 109, 111, 115, 116, 117, 119, 281, 360, 391
BACKSCHAUFEL, GELOCH	102, 104, 105, 109, 110, 111
BAGUETTEFORM	415
BAIN MARIE	23, 25, 403, 466, 472
BATLÖFFEL	249
BATTERIE, B-TLG	33, 35, 37, 39, 41, 43, 45
BESTECK	311
BESTECKBEHÄLTER	311
BESTECKKÖCHER	113
BESTECKKÖCHER	243, 311
BLACKBLECH	28
BLÄTTER	91, 414, 450
BRATENTOPF	18, 21, 24, 25, 33, 32, 34, 36, 38, 40, 42, 44, 46, 48, 51, 53, 55, 57, 58, 59, 61, 69, 130, 131, 132
BRATENTOPF	49, 55
BRATPFANNE	23, 28, 88, 89
BRENNER	395, 467
BRENNPASTE	62, 322
BRÖT-/OBSTKORB	187, 188, 335, 336
BRÜLLIERBRENNEN	394, 395
BRUSH FÜR SCHNEIDEBRETT	310
BUTTERDOSE MIT DECKEL	206
C	
CAMPING TELLER	160
CHAFING DISH	315, 316, 317, 318, 319, 320, 321, 473
CHAFING HEIZUNG	320, 474
CHAMPAGNERKÜHLE	236, 237, 238, 239, 240
COCKTAILMASS	248
COCKTAILSHARKER	247
COOKINGME	426, 427
CRÊPES-PFANNE	73, 76, 79, 80, 86, 465
D	
DAMPFKOCH-AUFSATZ	21, 33, 35, 37, 39, 41, 43, 45, 127
DAMPFKOCHGERÄT	451
DECKEL	20, 23, 25, 28, 31, 33, 35, 37, 39, 41, 43, 45, 47, 51, 53, 55, 64, 77, 89
DEKORIEREN DOSIERFLASCHE	140, 403
DEKORIEREN PLASTIKKAMME	389
DESENÖFFNER	281, 303
DESINFIZIATIONSMITTEL	375
DÖPPEL-BÖDEN	345, 346, 347
DOSIERER	142, 143, 396, 397
DOSIERFLASCHE	140, 403
DOSIERFLASCHE	249
DREIECK	130
E	
EIER OPENER	123
EIERFORM	123
EIER-SEPARATOR	123
EIMER	126
EIS MACHINE	430
EIS MASCHINEN	518
EIS-CRUSHER	247, 519
EISKELCH	405
EISPORTIONIERER	405, 406
EITELLER	160
EI-UNTERSTÜTZUNG	123
ELEKTRITOASTER	337, 338, 339, 484, 485, 486
ELEKTROFLIEGENFÄNGER	524, 525, 526
ELEKTROGRILL	462
ELEKTROKOCHTOPF	428
ENTBLÄTTERER FÜR GEWÜRZKRÄUTER	132, 285
ESPLUMADOR DE LEITE	218, 479
F	
FETTABSCHIEDER	201
FILTERKAFEE	482, 483
FISCHHEBER	102, 108, 109
FISCHKESSEL	28
FISCHSCHUPPENENTFERNER	214
FLASCHE VORBEREITUNG VERZIERUNG	201
FLASCHENKÜHLER	235
FLASCHENUNTERSETZER	160
FLEISCHKLOPFER	133
FLEISCHSPIESSE	113
FLEISCHTOPF	18, 22, 24, 26
FLEISCHWOLF	443, 444, 445
FLEISCHZANGE	287
FOLIENCUTTER	251
FONDUE	62
FRITEUSE	452, 453, 454, 455
FRIERLÖFFEL	103
FRÜHSTÜCKSTELLER	165, 167, 175, 354, 355
G	
GASANZÜNDER	208
GASKÖCHER-STÄNDE	99
GEFLÜGELSCHERE	300
GEL MIT ALKOHOL	375
GEMÜSESCHNEIDER	446, 447, 449
GEMÜSETOPF	19, 22
GETRÄNKEBELHÄLTER	322
GETRANKENPENDER	323, 474
GETRÄNKESPENDER, ISOLIERT	232, 323, 474
GEWÜRZDOSE/STREUER	203, 204
GEWÜRZKASTEN	139
GISSLÖFFEL, QUER	102
GLAS	355
GLASSER	242, 243
GLASUNTERSETZER	160
GN DECKEL	345, 346, 347
GN ZWISCHENSTENG	345
GN-BEHÄLTER	178, 179, 342, 343, 344, 345, 346, 347, 348, 349
GN-BEHÄLTER, PERFORIERT	343, 344
GRILL	51, 55, 79, 80, 81, 82
GRILL	90, 345, 415
GRILL	462, 463, 464
GRILLPFANNE	404
GRILLSPIEB	75
H	
HACKFLEISCHMESSER	297
HALTERUNG	354
HAMMER	133
HÄNDETROCKNER	376
HANDSCHUH	57, 79, 93, 94
HÄNGELEISTE	113
HOHER FLEISCHTOPF	32, 36, 38, 40, 42, 44
HÖLZ-STÖSSEL	129
HONIGBEHÄLTER	204, 324, 326, 377
HONIGLÖFFEL	213
HULLE	233, 493
HUMMERGABEL	214
HUMMERZANGE	213, 214
I	
INDUKTIONSKOCHFELD	315, 316, 317, 318, 326, 327, 328, 458, 459, 460
ISOLATIONSKUGELN FÜR SOUS VIDE	514

ISOTHERMAL SCHALE/TABLETT	354	OVAL BRATENTOPF	57, 58, 59, 60, 189, 190, 191, 192
J			
JOGHURT-MAKER	429		
K			
KAFFEE VERANSTALTER	325		
KAFFEEKANNE	219, 220, 221, 222, 481		
KÄSREIBE	134, 287, 288, 289		
KASSEROLLE, BAUCHIG	27		
KEKSSTEMPEL	393		
KERAMIKKÖCHFELD	328, 460		
KETTE	416		
KNOBLAUCHPRESSE	281		
KÖCHER	127		
KORB	195, 196		
KORKEN	251		
KORKENZIEHER	250, 251		
KRÄTERKOCHE SIEB	127		
KREISEL	147		
KRÜMELBÜRSTE	207, 379		
KÜCHE ZEICHENKETTE	91		
KÜCHENEAAGE	149, 150, 151, 152, 385, 522		
KÜCHENFORM	408, 409, 410, 411, 412, 413, 414, 416, 417, 418, 419, 423		
KÜCHENHANDSCHUH	92, 93, 294		
KUCHENPLATTE	169, 404		
KÜCHENSCHAUFEL	104, 281		
KÜCHEN-ZEITSCHALTUHR	94, 155		
KUSKUSTOPF	127		
L			
LEDERSCHNUR	261		
LÖFFELSAMMLER IN GESCHIRR	103		
M			
MÄGNETHALTERUNG FÜR MESSER	301		
MANDOLINE	290, 291		
MANUELLE WURSTTÜLLER	138		
MARKER TAFEL	255, 521		
MASCHINE FUER GLAS COOL	520		
MEHLBEHÄLTER	128		
MEHLSCHAUSEL	247, 385		
MEHLSIEB	386		
MENAGE	199, 200		
MENÜKARTENHALTER	206		
MENÜ-STÄNDER	214, 253		
MESSER	280, 281, 282, 295, 296, 297, 298, 299		
MESSERHALTER	297, 298		
MESSERTASCHE	298		
MESSGERÄT	125, 384, 385		
METZGERHAKEN	113, 298		
MIKROWELLE	456, 457		
MILCHKANNE	217, 222		
MILCHTOPF	27, 33, 35, 37, 39, 41, 43, 45		
MINI GRILL	59, 61, 191, 193		
MINI-WÜRFEL	195		
MIXER	430, 431, 432, 433, 435, 436, 437, 438, 439, 440, 441, 442, 443, 444, 455, 456, 457, 459, 500		
MOJITOSTÖßEL	248		
MÖRSER	135		
MULTIFUNKTIONS-ROBOTER	449		
N			
NESTBACKLÖFFEL	103		
NUDELKÖCH-EINSATZ	33, 37		
NUSSKNACKER	214		
O			
OBSTSCHALE AUS GITTERSTÄBEN	186, 187, 334, 335		
OBSTTROCKNER	450, 451		
OFEN	456		
ÖLKANNE	200, 201		
ÖL-SPRAY	201		
ORGANIZER FÜR COCKTAILZUBEHÖR	246		
P			
PARMESAMENAGE	205		
PASSIERGERÄT	131, 133		
PASTETENFORMEN	133		
PERSÖNLICHE FLASCHE	233		
PFANNE	19, 22, 25, 27, 61, 75, 79, 96, 97, 98, 99, 196		
PFANNE	31, 37, 45, 47, 51, 53, 55, 69, 70, 71, 72, 73, 74, 75, 78, 60, 61, 62, 83, 84, 85, 86		
PFANNE	31, 33, 35, 37, 39, 41, 43, 51, 53		
PINSEL	119, 122, 391		
PISTOLE FÜR TÜLLENSATZE	403		
PIZZABLECH	417		
PIZZAOFEN-SCHAUFEL	117		
PIZZASCHNEIDER	117, 287		
PIZZASPATEL	117		
PLATTE GRILL	76, 79, 461		
PRALINENGIESSFORM	421		
PUDDING-/BECHERFÖRMCHEN	414, 416, 417		
R			
RACK FÜR SOUS VIDE	514		
RAUCHEMEHL	146		
RAUCHERGLÖCKE	145		
RESERVED INDIKATOR	206		
REZEPTIONSKLINGEL	206		
RINGSTÄNDER	126		
ROLLENHALTER	504		
ROLLFILM	377		
RUHRPATEL	117		
RUNGSTOOLS	389		
S			
SAFTBEHÄLTER	322		
SAHNEBEREITER	141, 398		
SALATSCHAUFEL	104		
SALATSCHÜSSEL	205		
SALZ-PFEFFERTREUER	202, 203, 204, 216, 217, 480		
SATZ-PFEFFER-SET	199, 200		
SAUCENGLIESSLÖFFEL	104, 105, 106, 109, 110		
SAUCIERE	205		
SAUTEUSE	20, 23, 25, 33, 45, 47		
SAUTEUSE, KONISCH	20, 23		
SCHÄLER	137, 283, 287		
SCHÄLER	280, 281, 282, 283		
SCHÄRFMASCHINE	302, 303, 523		
SCHAUFEL	118, 389		
SCHAUMLÖFFEL	102, 103, 104, 105, 106, 107, 108, 109, 110		
SCHINKENHALTER	310		
SCHNEEBESEN	106, 109, 119, 120, 121, 221, 387, 391		
SCHNEIDEBRETT	304, 305, 306, 307, 308, 309, 310		
SCHNEIDER	132, 280, 281, 283, 284, 285, 286, 287, 448		
SCHNELLKÖCHTOPF	64, 65, 66, 67		
SCHÖKOLADEN FONTÄNE	330, 466		
SCHÖPFKELLE	102, 104, 105, 106, 107, 108, 109, 110, 171		
SCHÖPFKELLE, GELOCHT	102, 171		
SCHÜRZE	378		
SCHÜSSEL	126, 384		
SCHWEIFSÄGE	392		
SEIHER, MIT STIEL	28, 33, 37, 39, 41, 43, 103, 129, 130, 248		
SEKTKÜHLER	238, 247		
SEKTKÜHLERSTÄNDER	236		
SERVIERLÖFFEL	102, 104, 105, 106, 107, 108, 109, 110, 111, 112, 119, 171, 174, 391		
SERVIERLÖFFEL, GELOCHT	102, 104, 105, 106, 109, 110, 111, 171		
SERVIERSCHÜSSEL	205		
SERVIENTABLET	355		
SERVIENTABLET 158, 159, 160, 161, 164, 165, 166, 167, 168, 169, 170, 172, 173, 174, 175, 176, 207			
SERVIENTABLET	159, 162, 171		
SERVIENTISCH	177, 194, 198		
SERVIENTISCH	197		
SERVIERWAGEN	352, 353, 355		
SERVIENTENPENDER	182, 207, 378		

DE Alphabetisch Index

SERVIETTENROLLE	378	WARMHALTEPLATTE	320, 329, 468, 474, 483
SILIKONGRIFF	51, 94	WASSER SAHNEBEREITER	248
SOSSENSPRITZE	139	WASSERKANNE	124, 241, 355
SOUS VIDE	512, 513	WASSERWARMER	224, 225, 226, 227, 228, 475, 476, 477, 478
SPAGHETTIHEBER	105, 106, 108, 109, 110	WEINKÜHLER	515, 516, 517
SPAGHETTI-MASS	137	WEINKÜHLER	517
SPESEKARTENMAPPE	25, 261, 262, 263, 264, 265, 266, 267, 268, 269, 270, 271, 272, 273, 274, 275, 276, 277	WEINPUMPE	251
SPICKNADEL	132	WEINREGAL	235, 245
SPRITZBEUTEL	399	WEINRING TROP-STOP	251
SPÜLKORB	369, 370, 371	WENDEWAFFLEISEN	466
STÄNDER EISKELCH	244, 245	WETZSTAHL	297, 299
STÄNDER FLUER BRENNER	99	WOK	35, 47, 73, 76, 78, 80, 85, 328, 460
STANDMIXER BRISK	435, 438		
STERILISIERUNGSSCHANK	523	Z	
STIELKASSEROLLE, FRANZÖSISCH	20, 23	ZAHNSTOCHERBÜCHSE	199
STIELKASSEROLLE, HFLACH	19, 23, 25, 27, 31, 32, 35, 36, 38, 40, 41, 42, 44, 45, 46, 48, 51, 53, 55, 75, 103	ZANGE	90, 171, 210, 211, 212, 213, 214, 247, 345, 404
STIELKASSEROLLE, HOCH	19, 23, 25, 27	ZANGES	90, 211, 213, 224, 345
STÖSSEL	135	ZELLELHALTER	113
STROHHALME	495	ZITRUS ENTSAFTER	490
SUPPENBEREITER	329, 330, 331, 468, 469, 472, 528, 529, 530, 531	ZITRUSPRESSE	136, 487, 488, 489, 491
SUPPENSCHÜSSEL	205	ZUCKERDOSE	206, 222
SUPPENTOPF	19, 22, 25, 27, 30, 32, 34, 36, 38, 40, 42, 44, 48, 53, 379, 461	ZWIEBELHACKER	134, 443
T			
TAFEL	251, 254, 255, 521		
TAFEL FÜR BESTELLUNGEN	264, 266		
TAFEL FÜR RECHNUNGEN	264, 266		
TASSE	354		
TEEKANNE	222, 223		
TEIGAUSSTECHER	392		
TEIGRÖLLER	388		
TEIGSCHABER	106, 116, 119, 390, 391		
TELLERABDECKUNG	206		
TELLERABDECKUNG	206, 355		
THERMOBEHÄLTER	232		
THERMOMETER	112, 153, 154, 155		
THERMOMOSKANNE	230, 231		
THERMOTRANS	351		
TISCHHALTERUNG	236		
FISCHLÄUFER	183		
TISCHNUMMERNSCHILD	205, 206		
TISCHSET	181, 182, 183, 184		
TISCHTUCHKLAMMER	206		
TISCH-VITRINE	256		
TISH-ABFALLBEHÄLTER	207, 376, 379		
TORTENNING	416, 422		
TORTENNING, GELOCHT	423		
TORTENTEILER	404		
TRANCHIERGABEL	102, 103, 104, 105, 106, 107, 111, 112, 295, 297		
TRICHTER	130, 251		
TUBULÄRE REGAL	353		
TÜLLENSATZ	400, 401		
TÜLLENSÄTZESPENDER	143, 397		
U			
UMRANDER FÜR COCKTAILGLÄSER	246		
UNTERSATZ	185		
UNTERSETZER	182		
V			
VAKUUM-BEHÄLTER	508		
VAKUUMBEUTEL	508		
VAKUUMBEUTEL RÖLLEN	508		
VAKUUMIERGERÄT	502, 504, 505, 506, 507		
VOLLE REGALE	358, 359, 360, 361, 362, 363, 364, 365, 366		
VORLEGETEILE	106		
W			
WANDFLASCHENÖFFNER	249		
WANDSPENSER SEIFE	373, 374		
WANDTRENNPFOSTEN	380		
WANNE	126		
WÄRMENLAMPE	330, 332, 333, 470, 471, 472		

A		
AIR POT	232, 323, 474	
AIRBRUSH	402, 467	
AIRPOT	323, 474	
APPLE CORER	281, 282, 296	
ASHTRAY	208, 381	
B		
BAGUETTE MOULD	415	
BAIN MARIE	23, 25, 403, 466, 472	
BAKING SHEET	90, 415	
BASE FOR BURNER	99	
BASKET	195, 196	
BATTER DISPENSER	143, 397	
BATTERY 8 PCS	33, 35, 37, 39, 41, 43, 45	
BIRD'S NEST MOULD	103	
BISCUIT STAMP	393	
BLACKBOARD	251, 254, 255, 521	
BOTTLE COOLER	235	
BOTTLE OPENER	249	
BOTTLE STAND	160	
BOWL 126, 165, 167, 170, 171, 172, 173, 174, 205, 354, 355, 364		
BOWL SATND	126	
BREAD BASKET	187, 188, 335, 336	
BRISK BLENDER STAND	435, 438	
BRUSH	119, 122, 391	
BRUSH FOR CUTTING BOARD	310	
BURNER	99	
BUTCHERS	113, 298	
BUTTER DISH WITH COVER	206	
C		
CAKE MARKER	404	
CAKE SPOON	104, 281	
CAKE STAND	169, 404	
CALL BELL	206	
CAMPING PLATE	160	
CAN OPENER	281, 303	
CAP	251	
CARAMIZER	395, 467	
CASSEROLE 162, 212, 213, 312, 313, 315, 316, 412, 414, 416, 418, 419, 513, 515, 517, 518, 519, 611, 613, 615, 617, 619, 621, 623, 625, 627, 629, 631, 633, 635, 637, 639, 641, 643, 645, 647, 649, 651, 653, 655, 657, 659, 661, 663, 665, 667, 669, 671, 673, 675, 677, 679, 681, 683, 685, 687, 689, 691, 693, 695, 697, 699, 701, 703, 705, 707, 709, 711, 713, 715, 717, 719, 721, 723, 725, 727, 729, 731, 733, 735, 737, 739, 741, 743, 745, 747, 749, 751, 753, 755, 757, 759, 761, 763, 765, 767, 769, 771, 773, 775, 777, 779, 781, 783, 785, 787, 789, 791, 793, 795, 797, 799, 801, 803, 805, 807, 809, 811, 813, 815, 817, 819, 821, 823, 825, 827, 829, 831, 833, 835, 837, 839, 841, 843, 845, 847, 849, 851, 853, 855, 857, 859, 861, 863, 865, 867, 869, 871, 873, 875, 877, 879, 881, 883, 885, 887, 889, 891, 893, 895, 897, 899, 901, 903, 905, 907, 909, 911, 913, 915, 917, 919, 921, 923, 925, 927, 929, 931, 933, 935, 937, 939, 941, 943, 945, 947, 949, 951, 953, 955, 957, 959, 961, 963, 965, 967, 969, 971, 973, 975, 977, 979, 981, 983, 985, 987, 989, 991, 993, 995, 997, 999, 1001, 1003, 1005, 1007, 1009, 1011, 1013, 1015, 1017, 1019, 1021, 1023, 1025, 1027, 1029, 1031, 1033, 1035, 1037, 1039, 1041, 1043, 1045, 1047, 1049, 1051, 1053, 1055, 1057, 1059, 1061, 1063, 1065, 1067, 1069, 1071, 1073, 1075, 1077, 1079, 1081, 1083, 1085, 1087, 1089, 1091, 1093, 1095, 1097, 1099, 1101, 1103, 1105, 1107, 1109, 1111, 1113, 1115, 1117, 1119, 1121, 1123, 1125, 1127, 1129, 1131, 1133, 1135, 1137, 1139, 1141, 1143, 1145, 1147, 1149, 1151, 1153, 1155, 1157, 1159, 1161, 1163, 1165, 1167, 1169, 1171, 1173, 1175, 1177, 1179, 1181, 1183, 1185, 1187, 1189, 1191, 1193, 1195, 1197, 1199, 1201, 1203, 1205, 1207, 1209, 1211, 1213, 1215, 1217, 1219, 1221, 1223, 1225, 1227, 1229, 1231, 1233, 1235, 1237, 1239, 1241, 1243, 1245, 1247, 1249, 1251, 1253, 1255, 1257, 1259, 1261, 1263, 1265, 1267, 1269, 1271, 1273, 1275, 1277, 1279, 1281, 1283, 1285, 1287, 1289, 1291, 1293, 1295, 1297, 1299, 1301, 1303, 1305, 1307, 1309, 1311, 1313, 1315, 1317, 1319, 1321, 1323, 1325, 1327, 1329, 1331, 1333, 1335, 1337, 1339, 1341, 1343, 1345, 1347, 1349, 1351, 1353, 1355, 1357, 1359, 1361, 1363, 1365, 1367, 1369, 1371, 1373, 1375, 1377, 1379, 1381, 1383, 1385, 1387, 1389, 1391, 1393, 1395, 1397, 1399, 1401, 1403, 1405, 1407, 1409, 1411, 1413, 1415, 1417, 1419, 1421, 1423, 1425, 1427, 1429, 1431, 1433, 1435, 1437, 1439, 1441, 1443, 1445, 1447, 1449, 1451, 1453, 1455, 1457, 1459, 1461, 1463, 1465, 1467, 1469, 1471, 1473, 1475, 1477, 1479, 1481, 1483, 1485, 1487, 1489, 1491, 1493, 1495, 1497, 1499, 1501, 1503, 1505, 1507, 1509, 1511, 1513, 1515, 1517, 1519, 1521, 1523, 1525, 1527, 1529, 1531, 1533, 1535, 1537, 1539, 1541, 1543, 1545, 1547, 1549, 1551, 1553, 1555, 1557, 1559, 1561, 1563, 1565, 1567, 1569, 1571, 1573, 1575, 1577, 1579, 1581, 1583, 1585, 1587, 1589, 1591, 1593, 1595, 1597, 1599, 1601, 1603, 1605, 1607, 1609, 1611, 1613, 1615, 1617, 1619, 1621, 1623, 1625, 1627, 1629, 1631, 1633, 1635, 1637, 1639, 1641, 1643, 1645, 1647, 1649, 1651, 1653, 1655, 1657, 1659, 1661, 1663, 1665, 1667, 1669, 1671, 1673, 1675, 1677, 1679, 1681, 1683, 1685, 1687, 1689, 1691, 1693, 1695, 1697, 1699, 1701, 1703, 1705, 1707, 1709, 1711, 1713, 1715, 1717, 1719, 1721, 1723, 1725, 1727, 1729, 1731, 1733, 1735, 1737, 1739, 1741, 1743, 1745, 1747, 1749, 1751, 1753, 1755, 1757, 1759, 1761, 1763, 1765, 1767, 1769, 1771, 1773, 1775, 1777, 1779, 1781, 1783, 1785, 1787, 1789, 1791, 1793, 1795, 1797, 1799, 1801, 1803, 1805, 1807, 1809, 1811, 1813, 1815, 1817, 1819, 1821, 1823, 1825, 1827, 1829, 1831, 1833, 1835, 1837, 1839, 1841, 1843, 1845, 1847, 1849, 1851, 1853, 1855, 1857, 1859, 1861, 1863, 1865, 1867, 1869, 1871, 1873, 1875, 1877, 1879, 1881, 1883, 1885, 1887, 1889, 1891, 1893, 1895, 1897, 1899, 1901, 1903, 1905, 1907, 1909, 1911, 1913, 1915, 1917, 1919, 1921, 1923, 1925, 1927, 1929, 1931, 1933, 1935, 1937, 1939, 1941, 1943, 1945, 1947, 1949, 1951, 1953, 1955, 1957, 1959, 1961, 1963, 1965, 1967, 1969, 1971, 1973, 1975, 1977, 1979, 1981, 1983, 1985, 1987, 1989, 1991, 1993, 1995, 1997, 1999, 2001, 2003, 2005, 2007, 2009, 2011, 2013, 2015, 2017, 2019, 2021, 2023, 2025, 2027, 2029, 2031, 2033, 2035, 2037, 2039, 2041, 2043, 2045, 2047, 2049, 2051, 2053, 2055, 2057, 2059, 2061, 2063, 2065, 2067, 2069, 2071, 2073, 2075, 2077, 2079, 2081, 2083, 2085, 2087, 2089, 2091, 2093, 2095, 2097, 2099, 2101, 2103, 2105, 2107, 2109, 2111, 2113, 2115, 2117, 2119, 2121, 2123, 2125, 2127, 2129, 2131, 2133, 2135, 2137, 2139, 2141, 2143, 2145, 2147, 2149, 2151, 2153, 2155, 2157, 2159, 2161, 2163, 2165, 2167, 2169, 2171, 2173, 2175, 2177, 2179, 2181, 2183, 2185, 2187, 2189, 2191, 2193, 2195, 2197, 2199, 2201, 2203, 2205, 2207, 2209, 2211, 2213, 2215, 2217, 2219, 2221, 2223, 2225, 2227, 2229, 2231, 2233, 2235, 2237, 2239, 2241, 2243, 2245, 2247, 2249, 2251, 2253, 2255, 2257, 2259, 2261, 2263, 2265, 2267, 2269, 2271, 2273, 2275, 2277, 2279, 2281, 2283, 2285, 2287, 2289, 2291, 2293, 2295, 2297, 2299, 2301, 2303, 2305, 2307, 2309, 2311, 2313, 2315, 2317, 2319, 2321, 2323, 2325, 2327, 2329, 2331, 2333, 2335, 2337, 2339, 2341, 2343, 2345, 2347, 2349, 2351, 2353, 2355, 2357, 2359, 2361, 2363, 2365, 2367, 2369, 2371, 2373, 2375, 2377, 2379, 2381, 2383, 2385, 2387, 2389, 2391, 2393, 2395, 2397, 2399, 2401, 2403, 2405, 2407, 2409, 2411, 2413, 2415, 2417, 2419, 2421, 2423, 2425, 2427, 2429, 2431, 2433, 2435, 2437, 2439, 2441, 2443, 2445, 2447, 2449, 2451, 2453, 2455, 2457, 2459, 2461, 2463, 2465, 2467, 2469, 2471, 2473, 2475, 2477, 2479, 2481, 2483, 2485, 2487, 2489, 2491, 2493, 2495, 2497, 2499, 2501, 2503, 2505, 2507, 2509, 2511, 2513, 2515, 2517, 2519, 2521, 2523, 2525, 2527, 2529, 2531, 2533, 2535, 2537, 2539, 2541, 2543, 2545, 2547, 2549, 2551, 2553, 2555, 2557, 2559, 2561, 2563, 2565, 2567, 2569, 2571, 2573, 2575, 2577, 2579, 2581, 2583, 2585, 2587, 2589, 2591, 2593, 2595, 2597, 2599, 2601, 2603, 2605, 2607, 2609, 2611, 2613, 2615, 2617, 2619, 2621, 2623, 2625, 2627, 2629, 2631, 2633, 2635, 2637, 2639, 2641, 2643, 2645, 2647, 2649, 2651, 2653, 2655, 2657, 2659, 2661, 2663, 2665, 2667, 2669, 2671, 2673, 2675, 2677, 2679, 2681, 2683, 2685, 2687, 2689, 2691, 2693, 2695, 2697, 2699, 2701, 2703, 2705, 2707, 2709, 2711, 2713, 2715, 2717, 2719, 2721, 2723, 2725, 2727, 2729, 2731, 2733, 2735, 2737, 2739, 2741, 2743, 2745, 2747, 2749, 2751, 2753, 2755, 2757, 2759, 2761, 2763, 2765, 2767, 2769, 2771, 2773, 2775, 2777, 2779, 2781, 2783, 2785, 2787, 2789, 2791, 2793, 2795, 2797, 2799, 2801, 2803, 2805, 2807, 2809, 2811, 2813, 2815, 2817, 2819, 2821, 2823, 2825, 2827, 2829, 2831, 2833, 2835, 2837, 2839, 2841, 2843, 2845, 2847, 2849, 2851, 2853, 2855, 2857, 2859, 2861, 2863, 2865, 2867, 2869, 2871, 2873, 2875, 2877, 2879, 2881, 2883, 2885, 2887, 2889, 2891, 2893, 2895, 2897, 2899, 2901, 2903, 2905, 2907, 2909, 2911, 2913, 2915, 2917, 2919, 2921, 2923, 2925, 2927, 2929, 2931, 2933, 2935, 2937, 2939, 2941, 2943, 2945, 2947, 2949, 2951, 2953, 2955, 2957, 2959, 2961, 2963, 2965, 2967, 2969, 2971, 2973, 2975, 2977, 2979, 2981, 2983, 2985, 2987, 2989, 2991, 2993, 2995, 2997, 2999, 3001, 3003, 3005, 3007, 3009, 3011, 3013, 3015, 3017, 3019, 3021, 3023, 3025, 3027, 3029, 3031, 3033, 3035, 3037, 3039, 3041, 3043, 3045, 3047, 3049, 3051, 3053, 3055, 3057, 3059, 3061, 3063, 3065, 3067, 3069, 3071, 3073, 3075, 3077, 3079, 3081, 3083, 3085, 3087, 3089, 3091, 3093, 3095, 3097, 3099, 3101, 3103, 3105, 3107, 3109, 3111, 3113, 3115, 3117, 3119, 3121, 3123, 3125, 3127, 3129, 3131, 3133, 3135, 3137, 3139, 3141, 3143, 3145, 3147, 3149, 3151, 3153, 3155, 3157, 3159, 3161, 3163, 3165, 3167, 3169, 3171, 3173, 3175, 3177, 3179, 3181, 3183, 3185, 3187, 3189, 3191, 3193, 3195, 3197, 3199, 3201, 3203, 3205, 3207, 3209, 3211, 3213, 3215, 3217, 3219, 3221, 3223, 3225, 3227, 3229, 3231, 3233, 3235, 3237, 3239, 3241, 3243, 3245, 3247, 3249, 3251, 3253, 3255, 3257, 3259, 3261, 3263, 3265, 3267, 3269, 3271, 3273, 3275, 3277, 3279, 3281, 3283, 3285, 3287, 3289, 3291, 3293, 3295, 3297, 3299, 3301, 3303, 3305, 3307, 3309, 3311, 3313, 3315, 3317, 3319, 3321, 3323, 3325, 3327, 3329, 3331, 3333, 3335, 3337, 3339, 3341, 3343, 3345, 3347, 3349, 3351, 3353, 3355, 3357, 3359, 3361, 3363, 3365, 3367, 3369, 3371, 3373, 3375, 3377, 3379, 3381, 3383, 3385, 3387, 3389, 3391, 3393, 3395, 3397, 3399, 3401, 3403, 3405, 3407, 3409, 3411, 3413, 3415, 3417, 3419, 3421, 3423, 3425, 3427, 3429, 3431, 3433, 3435, 3437, 3439, 3441, 3443, 3445, 3447, 3449, 3451, 3453, 3455, 3457, 3459, 3461, 3463, 3465, 3467, 3469, 3471, 3473, 3475, 3477, 3479, 3481, 3483, 3485, 3487, 3489, 3491, 3493, 3495, 3497, 3499, 3501, 3503, 3505, 3507, 3509, 3511, 3513, 3515, 3517, 3519, 3521, 3523, 3525, 3527, 3529, 3531, 3533, 3535, 3537, 3539, 3541, 3543, 3545, 3547, 3549, 3551, 3553, 3555, 3557, 3559, 3561, 3563, 3565, 3567, 3569, 3571, 3573, 3575, 3577, 3579, 3581, 3583, 3585, 3587, 3589, 3591, 3593, 3595, 3597, 3599, 3601, 3603, 3605, 3607, 3609, 3611, 3613, 3615, 3617, 3619, 3621, 3623, 3625, 3627, 3629, 3631, 3633, 3635, 3637, 3639, 3641, 3643, 3645, 3647, 3649, 3651, 3653, 3655, 3657, 3659, 3661, 3663, 3665, 3667, 3669, 3671, 3673, 3675, 3677, 3679, 3681, 3683, 3685, 3687, 3689, 3691, 3693, 3695, 3697, 3699, 3701, 3703, 3705, 3707, 3709, 3711, 3713, 3715, 3717, 3719, 3721, 3723, 3725, 3727, 3729, 3731, 3733, 3735, 3737, 3739, 3741, 3743, 3745, 3747, 3749, 3751, 3753, 3755, 3757, 3759, 3761, 3763, 3765, 3767, 3769, 3771, 3773, 3775, 3777, 3779, 3781, 3783, 3785, 3787, 3789, 3791, 3793, 3795, 3797, 3799, 3801, 3803, 3805, 3807, 3809, 3811, 3813, 3815, 3817, 3819, 3821, 3823, 3825, 3827, 3829, 3831, 3833, 3835, 3837, 3839, 3841, 3843, 3845, 3847, 3849, 3851, 3853, 3855, 3857, 3859, 3861, 3863, 3865, 3867, 3869, 3871, 3873, 3875, 3877, 3879, 3881, 3883, 3885, 3887, 3889, 3891, 3893, 3895, 3897, 3899, 3901, 3903, 3905, 3907, 3909, 3911, 3913, 3915, 3917, 3919, 3921, 3923, 3925, 3927, 3929, 3931, 3933, 3935, 3937, 3939, 3941, 3943, 3945, 3947, 3949, 3951, 3953, 3955, 3957, 3959, 3961, 3963, 3965, 3967, 3969, 3971, 3973, 3975, 3977, 3979, 3981, 3983, 3985, 3987, 3989, 3991, 3993, 3995, 3997, 3999, 4001, 4003, 4005, 4007, 4009, 4011, 4013, 4015, 4017, 4019, 4021, 4023, 4025, 4027, 4029, 4031, 4033, 4035, 4037, 4039, 4041, 4043, 4045, 4047, 4049, 4051, 4053, 4055, 4057, 4059, 4061, 4063, 4065, 4067, 4069, 4071, 4073, 4075, 4077, 4079, 4081, 4083, 4085, 4087, 4089, 4091, 4093, 4095, 4097, 4099, 4101, 4103, 4105, 4107, 4109, 4111, 4113, 4115, 4117, 4119, 4121, 4123, 4125, 4127, 4129, 4131, 4133, 4135, 4137, 4139, 4141, 4143, 4145, 4147, 4149, 4151, 4153, 4155, 4157, 4159, 4161, 4163, 4165, 4167, 4169, 4171, 4173, 4175, 4177, 4179, 4181, 4183, 4185, 4187, 4189, 4191, 4193, 4195, 4197, 4199, 4201, 4203, 4205, 4207, 4209, 4211, 4213, 4215, 4217, 4219, 4221, 4223, 4225, 4227, 4229, 4231, 4233, 4235, 4237, 4239, 4241, 4243, 4245, 4247, 4249, 4251, 4253, 4255, 4257, 4259, 4261, 4263, 4265, 4267, 4269, 4271, 4273, 4275, 4277, 4279, 4281, 4283, 4285, 4287, 4289, 4291, 42		

EN Alphabetical index

H			
HAMMER	133		
HAM-SUPPORT	310		
HAND DRYER	376		
HEATER	329, 330, 331, 468, 469, 472, 528, 529, 530, 531		
HEATING LAMP	330, 332, 333, 470, 471, 472		
HERB STRIPPER	132, 285		
HONEY SPOON	213		
HYDROALCOHOLIC GEL	375		
HYGIENISING	375		
I			
ICE BUCKET	238, 247		
ICE CREAM MAKING MACHINE	430		
ICE CREAM SCOOP	405, 406		
ICE CRUSHER	247, 519		
ICE CUBES MAKER	518		
ICE SHOVEL	247, 385		
INDEX CARD FASTENER	354		
INDIVIDUAL PLACEMENT	181, 182, 183, 184		
INDUCTION PLATE	315, 316, 317, 318, 326, 327, 328, 458, 459, 460		
ISOTHERMAL TRAY	354		
J			
JIGGER	248		
JUICE DISPENSER	322		
JUICE EXTRACTOR	490		
K			
KETTLE	224, 225, 226, 227, 228, 475, 476, 477, 478		
KITCHEN STRING	91		
KITCHEN TIMER	94, 155		
KITCHEN TOOL SET	106		
KNIFE	280, 281, 282, 295, 296, 297, 298, 299		
KNIFE BLOC	297, 298		
KNIFE SHARPENER	302, 303, 523		
KNIFE STERILIZATION	523		
L			
LADLE	102, 104, 105, 106, 107, 108, 109, 110, 171		
LEATHER LACE	281		
LID	20, 23, 25, 28, 31, 33, 35, 37, 39, 41, 43, 45, 47, 51, 53, 55, 64, 77, 89		
LOBSTER CRACKER	213, 214		
LOW CASSEROLE	49, 55		
LOW STOCK POT	19, 22		
M			
MACE	248		
MAGNET SUPPORT	301		
MANDOLINE	290, 291		
MANUAL STUFFER	138		
MARKERS BLACKBOARD	255, 521		
MEASURER	125, 384, 385		
MEAT MINCER	443, 444, 445		
MEAT TENDERIZER	133		
MEAT TONG	287		
MENU CARD HOLDER	206		
MENU COVER	255, 261, 282, 283, 284, 285, 286, 287, 288, 289, 270, 271, 272, 273, 274, 275, 276, 277		
MENU HOLDER LECTERN	214, 253		
MESH SKIMMER	103		
MICROWAVE	456, 457		
MILK FROTHER	218, 479		
MINI GRILL	59, 61, 191, 193		
MINI-CUBE	195		
MITTEN	57, 79, 93, 94		
MIXER	430, 431, 432, 433, 435, 436, 437, 438, 439, 440, 441, 442, 443, 444, 445, 446, 47, 48, 500		
MIXING BOWL	126		
MORTAR	135		
MOSKITO KILLER	524, 525, 526		
MULTIFUNCTION ROBOT	449		
N			
NAPKIN HOLDER	182, 207, 378		
NOZZLES	400, 401		
NUT CRACKER	214		
O			
OIL CAN	200, 201		
OIL SPRAYER	201		
ONE PIECE CROSS SPOON	102		
ORDER HOLDER	264, 266		
ORDER ROLL	113		
OUSTER OPENER	214, 281		
OVAL CASSEROLE	57, 58, 59, 60, 189, 190, 191, 192		
OVEN	458		
OVEN TRAY	28		
P			
PAIL	126		
PARMESAN BOWL	205		
PASTA COOKER	33, 37		
PASTA MEASURER	137		
PASTRY BAG	399		
PASTRY DISPLAY	119, 391		
PASTRY MOULD	408, 409, 410, 411, 412, 413, 414, 416, 417, 418, 419, 423		
PASTRY RACK	404		
PEELER	280, 281, 282, 283		
PERFORATED CONTAINER	343, 344		
PERFORATED LADLE	102, 171		
PERFORATED RINGS	423		
PERFORATED SPATULA	102, 104, 105, 109, 110, 111		
PERFORATED SPOON	102, 104, 105, 106, 109, 110, 111, 171		
PERSONAL BOTTLE	233		
PESTLE	135		
PINAFORE	378		
PIZZA CUTTER	117, 287		
PIZZA FLAT SCOOP	117		
PIZZA MOULD	417		
PIZZA SPATULA	117		
PLATE	165, 167, 175, 354, 355		
PLATE COVER	208, 355		
PORTIONNER	142, 143, 396, 397		
POTATO MASHING MACHINE	131, 133		
POURER	249		
PRESSURE COOKER	64, 65, 66, 67		
PUDDING MOLD	414, 416, 417		
PUSHER	423		
R			
RACK	369, 370, 371		
RACK FOR DOUS VIDE	514		
RESERVED SIGNAL	206		
RINGS	416, 422		
ROASTER	23, 28, 88, 89		
ROLL DISPENSER	378		
ROLL HOLDER	504		
ROLLING PIN	388		
ROTISSERIE	75		
ROUND	19, 22, 25, 27, 61, 75, 79, 96, 97, 98, 99, 196		
ROUND DISH	31, 33, 35, 37, 39, 41, 43, 51, 53		
ROUNDED SAUCEPAN	27		
S			
SALAD BOWL	205		
SALAMANDER	462		
SALAT SCOOP	104		
SALT-PEPPER SET	199, 200		
SAUCE SYRINGE	139		
SAUCEPAN	19, 23, 25, 27, 31, 32, 35, 36, 38, 40, 41, 42, 44, 45, 46, 48, 51, 53, 55, 75, 103		
SAUTEUSE	20, 23, 25, 33, 45, 47		
SCALE	149, 150, 151, 152, 385, 522		
SCISSORS	300		
SCRAPER	118, 389		
SEAFOOD FORKS	214		
SEPARATOR POST	380		
SERVICE TROLLEY	352, 353, 355		

EN Alphabetical index

SERVING TABLE	177, 194, 198
SERVING TABLE	197
SERVING TRAY	159, 162, 171
SHAPE EGG MOULD	123
SHARKER	203, 204
SHARPENING	297, 299
SHEETS	91, 414, 450
SHELVING	358, 359, 360, 361, 362, 363, 364, 365, 366
SHOVEL	117
SIEVE	386
SILICONE HANDLE	51, 94
SKEWERSQUARE	113
SKIMMER	102, 103, 104, 105, 106, 107, 108, 109, 110
SLEEVE	233, 493
SLICER	137, 283, 287
SMOKER	144, 146
SMOKER HOOD	145
SOAP WALL DISPENSER	373, 374
SOUP-TUREEN	205
SOUS VIDE	512, 513
SOUS VIDE INSULATION BALLS	514
SPAGUETTI SERVER	105, 106, 108, 109, 110
SPATULA	108, 116, 119, 390, 391
SPATULA	102, 105, 106, 107, 109, 111, 115, 116, 117, 119, 281, 390, 391
SPICE COOKER	127
SPINNER	147
SPLITTING GUIDES	345
SPOON	102, 104, 105, 106, 107, 108, 109, 110, 111, 112, 119, 171, 174, 391
SPOON HOLDER UTENSILS	103
SPOUT FOR WINE	251
SQUEEZE BOTTLE	140, 403
SQUEEZER	136, 487, 488, 489, 491
STEAM CASSEROLE	21, 33, 35, 37, 39, 41, 43, 45, 127
STEAM COOKER	451
STEAMER	127
STOCK POT	19, 22, 25, 27, 30, 32, 34, 36, 38, 40, 42, 44, 48, 53, 379, 461
STRAINER	28, 33, 37, 39, 41, 43, 103, 129, 130, 248
STRAWS	495
STUFFING NEEDLE	132
SUGAR BOWL	206, 222
SWEDISH SAW	392

T

TABLE BIN	207, 376, 379
TABLE NUMBERS	205, 206
TABLE RUNNER	183
TABLECLOTH PROTECTOR	185
TABLECLOTHS PEGS	206
TEA POT	222, 223
TERMO JUG	230, 231
THERMO	232
THERMOMETER	112, 153, 154, 155
THERMOTRANS	351
TICKET HOLDER	264, 266
TOASTER	337, 338, 339, 484, 485, 486
TONG	90, 171, 210, 211, 212, 213, 214, 247, 345, 404
TONGS	90, 211, 213, 224, 345
TOOLS	389
TOOTHPICK	199
TRAY	355
TRAY	158, 159, 160, 161, 164, 165, 166, 167, 168, 169, 170, 172, 173, 174, 175, 176, 207
TRIANGLE	130
TRING	416
TUBULAR SHELF	353

V

VACUUM BAGS	508
VACUUM CANISTERS	508
VACUUM PACK MACHINE	502, 504, 505, 506, 507
VEGETABLE DISH	205
VEGETABLES CUTTER	446, 447, 449
VINE BUCKET	236, 237, 238, 239, 240
VINE RACK	235, 245

W

WAFFLE MAKER	466
WALL HANGER	113
WARMING PLATE	320, 329, 468, 474, 483
WATER JUG	124, 241, 355
WATER WHIPPER	248
WHIPPER	141, 398
WHISK	106, 109, 119, 120, 121, 221, 387, 391
WINE COOLER	515, 516, 517
WINE DRIP STOP RING	251
WINE STAND	236
WINE TABLE SUPPORT	236
WINE VACUUM SEALER	251
WOK	35, 47, 73, 76, 78, 80, 85, 328, 460
WOOD CHIPS	146

Y

YOGHURT MAKER	429
---------------	-----

A			
ABERTO-OSTRAS	214, 281	CARIMBOS PARA BOLACHAS	393
ABRE-LATAS	281, 303	CARRO SERVIÇO	352, 353, 355
ABRIDOR DE GARRAFAS	249	CENTRIFUGADORA	147
AÇUCAREIRO	206, 222	CEPILHO PARA TÁBUA DE CORTE	310
AERÓGRAFO	402, 467	CESTA	369, 370, 371
AFIADOR DE FACAS	302, 303, 523	CESTA	195, 196
AGULHA DE MECHAR	132	CESTA DE PÃO	187, 188, 335, 336
AIR POT	232, 323, 474	CESTO PARA FRUITA	186, 187, 334, 335
AIRPOT	323, 474	CHAFING DISH	315, 316, 317, 318, 319, 320, 321, 473
ANILHA ANTI-GOTA	251	CHALEIRA	224, 225, 226, 227, 228, 475, 476, 477, 478
AQUECEDOR	329, 330, 331, 468, 469, 472, 528, 529, 530, 531	CHÁVENA	354
AQUECEDOR CHAFING	320, 474	CINZEIRO	208, 381
AQUECEDOR DE LÍQUIDOS	322	CLOCHE PARA PRATOS	206, 355
ARDÓSIA	251, 254, 255, 521	CLOQUE PARA QUEIJO/TARTES	206
ARGAMASSA	135	COADOR	28, 33, 37, 39, 41, 43, 103, 129, 130, 248
ARMÁRIO ESTERILIZADOR	523	COBERTO	311
ARMÁRIO REFRIGERADOR	515, 516, 517	COLHER COCKTAIL	249
ARO	416, 422	COLHER LISA	102, 104, 105, 106, 107, 108, 109, 110, 111, 112, 119, 171, 174, 391
ARO PERFURADO	423	COLHER OBLÍQUA	102
ARREFECEDOR DE GARRAFAS	235	COLHER PARA MEL	213
ASA DE SILICONE	51, 94	COLHER PERFURADA	102, 104, 105, 106, 109, 110, 111, 171
ASSADEIRA	23, 28, 88, 89	COLHER RECOLHE UTENSÍLIOS	103
ATRIL PORTA-MENU	214, 253	CONCHA	102, 104, 105, 106, 107, 108, 109, 110, 171
AVENTAL	378	CONCHA PARA MOLHO	104, 105, 106, 109, 110
AZEITEIRA	200, 201	CONCHA PERFURADA	102, 171
B		COOKINGME	426, 427
BACIA	126, 165, 167, 170, 171, 172, 173, 174, 205, 354, 355, 384	COPO	355
BACIA	126	COPOS PARA TALHERES	113
BACIA CÔNICA	126, 384	COPOS PARA TALHERES	243, 311
BACIA DA ENSALADA	205	COPOS/CÁLICES	242, 243
BALANÇA	149, 150, 151, 152, 385, 522	CORDÃO DE COURO	261
BALDE	126	CORRE MESA	183
BANDEJA	355	CORREDOR	247, 385
BANDEJA / TRAVESSA	158, 159, 160, 161, 164, 165, 166, 167, 168, 169, 170, 172, 173, 174, 175, 176, 27	CORRENTE	416
BANDEJA DE SERVIR	159, 162, 171	CORTA VEGETALES	446, 447, 449
BANDEJA FORNO	28	CORTADOR	132, 280, 281, 283, 284, 285, 286, 287, 448
BANDEJA ISOTÉRMICA	354	CORTADORA DE FIAMBRE	448
BANHO-MARIE	23, 25, 403, 466, 472	CORTA-MASSAS	392
BARRA FIXAÇÃO NOTAS	113	CORTA-PIZZA	117, 287
BASES PARA COPOS	182	COUSCOUSEIRAR	127
BATEDEIRA	40, 41, 42, 43, 45, 46, 47, 48, 49, 40, 41, 42, 43, 44, 45, 46, 47, 48, 50	COZEDOR DE ESPECIARIAS	127
BATEDOR	108, 109, 119, 120, 121, 221, 387, 391	COZE-MASSAS	33, 37
BATERIA 8 PCS	33, 35, 37, 39, 41, 43, 45	CREMALHEIRA DO VINHO	235, 245
BLADE ARREFECEDORA DE GARRAFAS	236, 237, 238, 239, 240	CREMALHEIRA PARA SOUS VIDE	514
BOBINA DE VÁCUO	508	CREPEIRA	73, 76, 79, 80, 86, 465
BOBINA FILME	377	CÚTELO	297
BOMBA VÁCUO	251	D	
BOQUILHA DE SERVIR	251	DECORADOR DE COPOS E TAÇAS	246
BOQUILHAS	400, 401	DEFUMADOR	144, 146
BULE	222, 223	DESCAPSULADOR	251
C		DESCAROÇADOR	281, 282, 286
ÇAÇAROLA	182, 242, 302, 343, 363, 404, 444, 464, 485, 535, 575, 596, 189, 191, 192	DESCASCADOR	137, 283, 287
ÇAÇAROLA A VAPOR	21, 33, 35, 37, 39, 41, 43, 45, 127	DESCASCADOR	280, 281, 282, 283
ÇAÇAROLA ALTA	18, 22, 24, 26	DESFOLHADOR DE ERVAS	132, 285
ÇAÇAROLA ALTA DIREITE	19, 23, 25, 27	DESIDRATADOR	450, 451
ÇAÇAROLA BAIXA	49, 55	DISIFICADOR LICOR	248
ÇAÇAROLA BÓJUDA	27	DISPENSADOR DE SABÃO	373, 374
ÇAÇAROLA CÔNICA	20, 23	DISTRIBUIDOR DE PASTELARIA	143, 397
ÇAÇAROLA DIREITE	19, 23, 25, 27, 31, 32, 35, 36, 38, 40, 41, 42, 44, 46, 46, 46, 51, 53, 55, 75, 103	DISTRIBUIDOR ZUMOS	322
ÇAÇAROLA OVAL	57, 58, 59, 60, 189, 190, 191, 192	DOSIFICADOR	204, 324, 325, 377
CAFÉ TIPO FILTRO	482, 483	DOSIFICADOR	142, 143, 396, 397
CAFETEIRA	219, 220, 221, 222, 481	DSECADOR DE MÃO	376
CAIXA	178, 179, 342, 343, 344, 345, 346, 347, 348, 349	DUPLO FUNDO	345, 346, 347
CAIXA CONDIMENTOS	139	E	
CAIXA PERFURADA	343, 344	EMPURRADOR	423
CAIXAS VÁCUO	508	ESCORREDOR	33, 37, 39, 41, 43, 128
CAMPAINHA	206	ESCORRE-FRITOS	128
CAMPANULA DEFUMADORA	145	ESCOVA APANHÁ-MIGALHAS	207, 379
CANEÇA CILÍNDRICA	27, 33, 35, 37, 39, 41, 43, 45	ESCUMADEIRA	102, 103, 104, 105, 106, 107, 108, 109, 110
CAPA PROTECTORA CARRO	352	ESCUMADEIRA	103
		ESFERAS ISOLANTES SOUS VIDE	514

PT Índice alfabético

ESMAGA-ALHOS	281	LUVA	92, 93, 294
ESPÁTULA	108, 116, 119, 390, 391	LUVA	233, 493
ESPÁTULA DE BOLOS	104, 281		
ESPAULA DE PEIXE	102, 108, 109		
ESPÁTULA LISA	102, 106, 106, 107, 109, 111, 115, 116, 117, 119, 281, 390, 391		
ESPÁTULA PERFURADA	102, 104, 105, 109, 110, 111		
ESPÁTULA PERFURADA	104		
ESPÁTULA PIZZA	117		
ESPÁTULA PIZZA	117		
ESPETO MORUNO	113		
ESPETOS PARA MARISCO	214		
ESPREMEDOR	136, 487, 488, 489, 491		
ESPUMADOR DE LEITE	218, 479		
ESTANTE	358, 359, 360, 361, 362, 363, 364, 365, 366		
EXPOSITO R PASTELERIA	119, 391		
F			
FAÇA	280, 281, 282, 295, 296, 297, 298, 299		
FARINHEIRO	128		
FECHO PARA BANDEJAS	354		
FERRAMENTAS	389		
FIO DE COZINHA	91		
FONDUE	62		
FORTE CHOCOLATE	330, 466		
FORMA FLAN	414, 416, 417		
FORMA PARA SALGADOS	133		
FORNÔ	456		
FRANCÊS CAÇAROLA	20, 23		
FRIGIDEIRA	20, 23, 25, 33, 45, 47		
FRIEDEIRA	452, 453, 454, 455		
FUNIL	130, 251		
FUSIL	297, 299		
G			
GANCHOS	113, 296		
GARFO	102, 103, 104, 105, 106, 107, 111, 112, 295, 297		
GARRAFA	140, 403		
GARRAFA DE PREPARAÇÃO ALINÔ	201		
GARRAFA DECORAÇÃO	140, 403		
GARRAFA DOSEADORA	249		
GARRAFA PESSOAL	233		
GEL COMBUSTIVEL	62, 322		
GEL HIDRO-ALCOOLICO	375		
GRELHA	127		
GRELHA	90, 345, 415		
GRELHA PASTELERIA	404		
GRELHADOR	75		
GRELHADOR	51, 55, 79, 80, 81, 82		
GRELHADOR	462, 463, 464		
GUARDANAPO	182, 207, 378		
GUIA DIVISORIA	345		
H			
HIGIENIZANTE	375		
I			
INDICADOR RESERVADO	206		
IOGURTEIRA	429		
ISQUEIRO	208		
J			
JARRA DE ÁGUA	124, 241, 355		
JARRA TERMO	230, 231		
JOGO DE COZINHA	106		
JOGO GALHETEIRO	199, 200		
JOGO SALEIRO-PIMENTEIRO	199, 200		
L			
LÂMINA	91, 414, 450		
LÂMPARA CALOR	330, 332, 333, 470, 471, 472		
LEGUMEIRA	205		
LEITEIRA	217, 222		
LIQUIDIFICADORAS	490		
MAÇO	248		
MALA CHEF	298		
MANDOLINA	290, 291		
MANGA DE PASTELERIA	399		
MANTEIGUEIRA	206		
MÁQUINA DE FAZER GELO	518		
MAQUINA DE FAZER GOFFRES	466		
MÁQUINA DE VACUO	502, 504, 505, 506, 507		
MÁQUINA PARA ENCHER SALSICHAS MANUAL	138		
MÁQUINA PARA ENFRIAR COPAS	520		
MÁQUINA PARA FAZER GELADO	430		
MARCADOR DE BOLOS	404		
MARCADORES ARDÔSIA	255, 521		
MARTELO	133		
MARTELO ABLANDADOR	133		
MATA MOSQUITOS	524, 525, 526		
MEDIDOR	125, 384, 385		
MEDIDOR PARA MACARRAO	137		
MICROONDAS	456, 457		
MINI GRILL	59, 61, 191, 193		
MINI-CUBO	195		
MOINHO	202, 203, 204, 216, 217, 480		
MOLDE OVO	123		
MOLDE PARA BOMBONS	421		
MOLDE PASTELERIA	415		
MOLDE PASTELERIA	408, 409, 410, 411, 412, 413, 414, 416, 417, 418, 419, 423		
MOLDE PIZZA	417		
MOLHEIRA	205		
N			
NINHOS DE ARAME	103		
NUMEROS PARA TABELA	205, 206		
O			
ORGANIZADOR ACCESSÓRIOS COCKTAILS	246		
ORGANIZADOR DE CAFÉ	325		
OVOS ABRIDOR	123		
P			
PÁ	117		
PAELHEIRA	19, 22, 25, 27, 61, 75, 79, 96, 97, 98, 99, 196		
PAELHEIRA GAS BUTANO	99		
PALHINHAS	495		
PALITEIRO	199		
PANELA	19, 22, 25, 27, 30, 32, 34, 36, 38, 40, 42, 44, 48, 53, 379, 461		
PANELA BAIXA	19, 22		
PANELA DE COCÇÃO	451		
PANELA DE PRESSÃO	64, 65, 66, 67		
PANELA ELÉCTRICA	428		
PANELA SUPER ALTA	32, 36, 38, 40, 42, 44		
PAPELEIRA	207, 376, 379		
PARTE-NOZES	214		
PASSA-PURÉ	131, 133		
PÉ PORTA BALDES	236		
PEGAS	57, 79, 93, 94		
PEIXEIRA	28		
PENEIRA	386		
PENTE DE DECORAÇÃO	389		
PICADORA	134, 443		
PICADORA DE CARNE	443, 444, 445		
PICADORA DE GELO	247, 519		
PILÃO P/ALMOFARIZ	135		
PILÃO P/PASSADOR CHINÊS	129		
PINÇA	90, 171, 210, 211, 212, 213, 214, 247, 345, 404		
PINÇA PARA TOALHAS	206		
PINÇA/PENTE CORTA-CARNE	287		
PINÇAS	90, 211, 213, 224, 345		
PINCEL	119, 122, 391		
PIPETA PARA MOLHO	139		

PT Índice alfabético

PISTOLA PASTELARIA	403	TAMPA PARA CAIXA	345, 346, 347
PLACA AQUECIMENTO	320, 329, 468, 474, 483	TAMPÃO	251
PLACA DE FORNO	90, 415	TAPETE	91, 414
PLACA DE INDUÇÃO 315, 316, 317, 318, 326, 327, 328, 458, 459, 460		TARTEIRA	31, 33, 35, 37, 39, 41, 43, 51, 53
PLACA VITROCERÂMICA	328, 460	TENAZ MARISCOS	213, 214
PLANCHA GRILL	76, 79, 461	TERMO	232
PÓLVILHADOR	203, 204	TERMÓMETRO	112, 153, 154, 155
PORTA COMANDAS	264, 266	TESOURAS	300
PORTA FATURAS	264, 266	THERMOTRANS	351
PORTA MENU 255, 261, 262, 263, 264, 265, 266, 267, 268, 269, 270, 271, 272, 273, 274, 275, 276, 277		TOALHA DE MESA INDIVIDUAL	181, 182, 183, 184
PORTA-CUBOS GELO	238, 247	TORRADEIRA	337, 338, 339, 484, 485, 486
PORTA-ROLOS	378	TRIÂNGULO	130
PORTA-TARTE	169, 404		
POSTE SEPARADOR	380	V	
POUSA-COPOS	160	VITRINA EXPOSITORA	256
POUSA-GARRAFAS	160		
PRATELEIRA TUBULAR	353	W	
PRATO	165, 167, 175, 354, 355	WOK	35, 47, 73, 76, 78, 80, 85, 328, 460
PRATO CAMPING	160		
PRATO DE OVOS	160		
PROTECTOR DE TOALHAS	185		
PULVERIZADOR	201		
Q			
QUEJEIRA	205		
QUEIMADOR	395, 467		
QUEIMADORA A GÁS	394, 395		
R			
RACIONADOR DE GELADO	405, 406		
RALADOR	134, 287, 288, 289		
RASPADOR	118, 389		
RASPADOR DE PEIXE	214		
REFRIGERADOR	517		
RELÓGIO DE COZINHA	94, 155		
ROBÔ MULTIFUNÇÃOAIS	449		
ROLO	388		
S			
SACA-ROLHAS	250, 251		
SACOS DE VÁCUO	508		
SALAMANDRA	462		
SEPARADOR DE GORDURAS	201		
SEPARADOR DE OVOS	123		
SERRA SUEXA	392		
SERRIN DE MADEIRA	146		
SERTÃ 31, 37, 45, 47, 51, 53, 55, 68, 70, 71, 72, 73, 74, 75, 78, 80, 81, 82, 83, 84, 85, 86			
SERVIDOR ESPARGUETE	105, 106, 108, 109, 110		
SHARKER	247		
SIFÃO	141, 398		
SIFÃO DE ÁGUA	248		
SOPEIRA	205		
SÓUS VIDE	512, 513		
SUPORTE BALDE DE ARREFECEDOR	236		
SUPORTE DE BACIAS	126		
SUPORTE DE BARRA	113		
SUPORTE DE OVO	123		
SUPORTE DE ROLO	504		
SUPORTE DE TAPAS	244, 245		
SUPORTE MAGNÉTICO	301		
SUPORTE MENU	206		
SUPORTE PAELHERIA	99		
SUPORTE PARA BATEDEIRA BRISK	435, 438		
SUPORTE PRESUNTO	310		
SUPORTE TALHERES	311		
T			
TÁBUA DE CORTE	304, 305, 306, 307, 308, 309, 310		
TÁBUA DE SERVIR	177, 194, 198		
TÁBUA DE SERVIR	197		
TAÇA	405		
TACO FACAS	297, 298		
TAMPA 20, 23, 25, 28, 31, 33, 35, 37, 39, 41, 43, 45, 47, 51, 53, 55, 64, 77, 89			

CGH-01/21

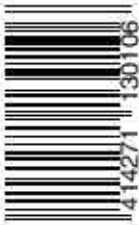

8 414271 130106



Lacor Menaje Profesional, S.L.

Bº San Juan, s/n -Apdo. 18

20570 Bergara (Gipuzkoa), Spain

Tel.: (Nacional) 943-76-90-30 / Fax: 943-76-53-87

Tel.: (Export) +34 943-76-91-74 / Fax: +34 943-76-92-22

comercial@lacor.es / export@lacor.es

Grupo Marcos Larrañaga y Cia



www.lacor.es